

DIAMOND SURGICAL
WWW.DIAMONDMED.IR INSTRUMENTS



VAG
Diagnostics



CE

SQS Certificate
ISO 9001:2000
ISO 13485:2003

1

www.Diamondmed.ir



Diagnostic
Diagnostic Sets
Diagnostik-Bestecke
Juegos para diagnostico

ابزار معاینه
اتوسکوپ
آفتالموسکوپ



CE

SQS Certificate
ISO 9001:2000
ISO 13485:2003

2



VAG300500



VAG300600



VAG300700



VAG300800



VAG300100

Otoscope set, consisting of battery handle
(without batteries), 3 ear specula, 1 bulb, in velvet lined case



Universal
VAG301000

www.Diamondmed.ir



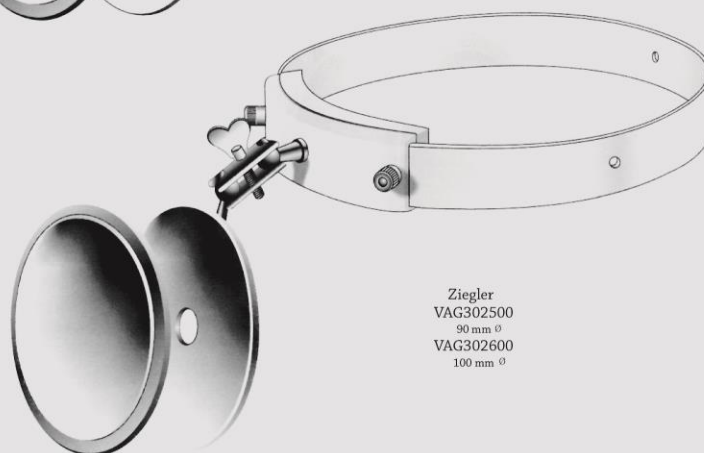
Diagnostic
Head Mirrors
Stirnspiegel
Espejos frontales



Ziegler
VAG301500
90 mm Ø
VAG301600
100 mm Ø



VAG302000
90 mm Ø
VAG302100
100 mm Ø



Ziegler
VAG302500
90 mm Ø
VAG302600
100 mm Ø

ابزار معاینه
هدلایت ها

ابزار جراحی
دایموند

CE

SQS Certificate
ISO 9001:2000
ISO 13485:2003

3



Diagnostic
Head Mirrors
Stirnspiegel
Espejos frontales

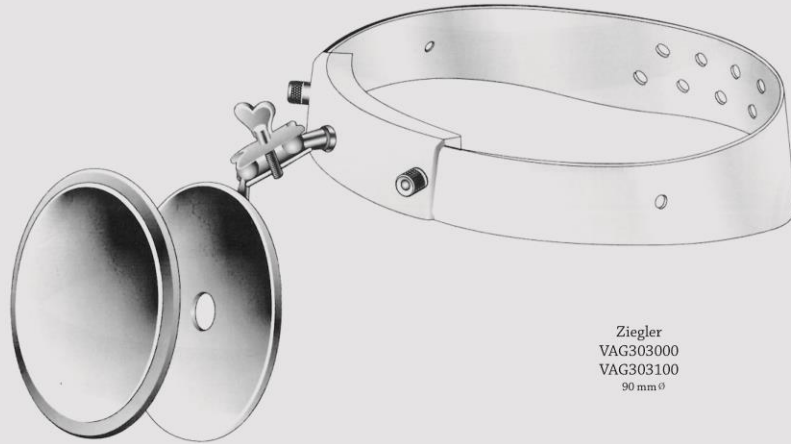
ابزار معاینه
هدلایت



CE

SQS Certificate
ISO 9001:2000
ISO 13485:2003

4



Ziegler
VAG303000
VAG303100
90 mm Ø



Ziegler
VAG303500
VAG303600
90 mm Ø



Ziegler
VAG304000
VAG304100
90 mm Ø



Diagnostic

Sensibility Instruments & Stethoscopes
Sensibilitats-Instrumente Y Stethoskope
Instrumentos para examinar la
sensibilidad und Estetoscopios



Wartenberg
VAG304518
18 cm / 7"
Pinwheel for neurological examination



Pinarad
VAG305015
With detachable base
VAG305115
With fixed base
15.5 cm / 6"
Aluminium



VAG305514
14.5 cm / 5 1/2"
Wooden

ابزار معاینه



CE

SQS Certificate
ISO 9001:2000
ISO 13485:2003

5



Diagnostic

Examination and Measuring Instruments (Calipers)
Prof- und Meßinstrumente (Schieblehren)
Instrumentos Para Exámenes Y medidas (Calibres)

ابزار معاینه
کالیپرها



SQS Certificate
ISO 9001:2000
ISO 13485:2003



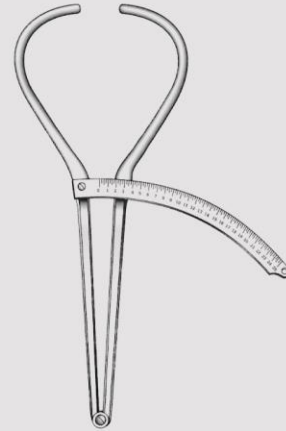
Townley
VAG30610
10 cm / 4"



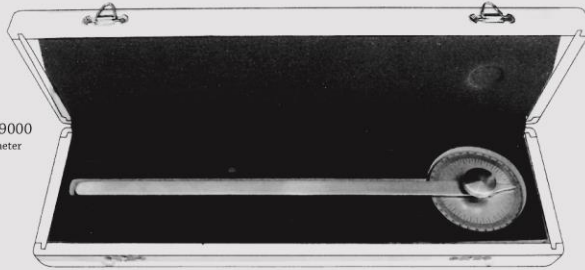
Marchac
VAG30650
Measuring rang 80 mm



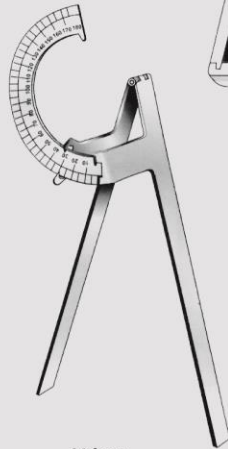
Jamison
VAG307000



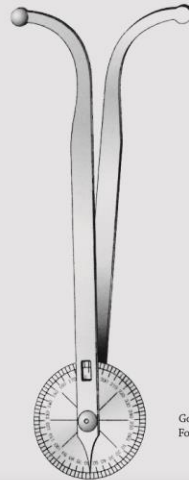
Bertillon
VAG307500



VAG309000
Goniometer



Moltgen
VAG308000
For extremities



Thole
VAG308534
34 cm / 13 1/2"
Goniometer, graduated in centimeters.
For internal & external measurements.



Diagnostic

Examination and Measuring Instruments (Calipers)
Prof- und Meßinstrumente (Schieblehren)
Instrumentos Para Exámenes Y medidas (Calibres)



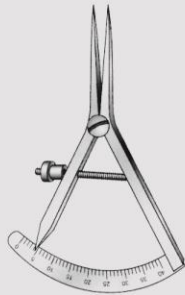
Castroviejo
VAG309508
8 cm / 3 1/4"
Measuring range 15 mm



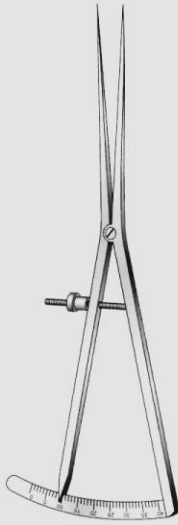
Castroviejo
VAG310008
8 cm / 3 1/4"
Measuring range 20 mm



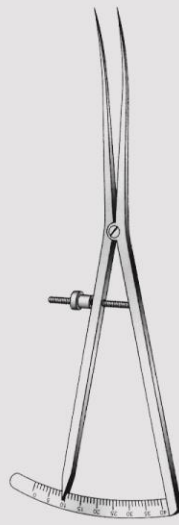
Castroviejo
VAG310508
8 cm / 3 1/4"
Measuring range 20 mm
Curved



Castroviejo-Epker
VAG311009
9 cm / 3 1/2"
Measuring range 40 mm



Castroviejo-Epker
VAG311518
18 cm / 7"
Measuring range 40 mm



Castroviejo-Epker
VAG312018
18 cm / 7"
Measuring range 40 mm
Curved

ابزار معاینه
کالیپر ها



CE

SQS Certificate
ISO 9001:2000
ISO 13485:2003

7

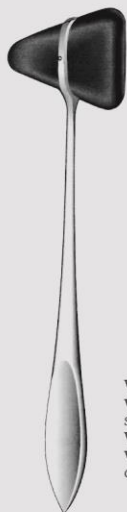


Diagnostic
Percussion Hammers
Perkussionshammer
Martillos de percusion

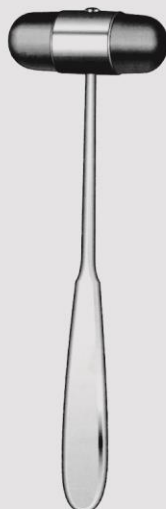
ابزار معاینه
چکش‌های رفلکس



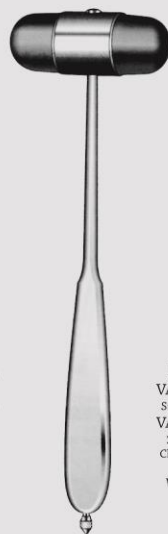
SQS Certificate
ISO 9001:2000
ISO 13485:2003



Taylor
VAG312518 18 cm / 7"
VAG312620 20 cm / 8"
Stainless steel
VAG313018 18 cm / 7"
VAG313120 20 cm / 8"
Chrome plated
(Brass)



Dejerine
VAG313520
Stainless steel
VAG313620
20 cm / 8"
Chrome plated
(Brass)

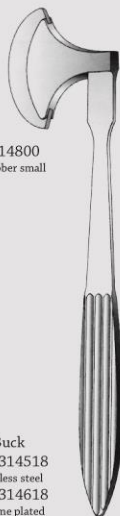


Dejerine
VAG314021
Stainless steel
VAG314121
21 cm / 8 1/4"
Chrome plated
(Brass)
With needle

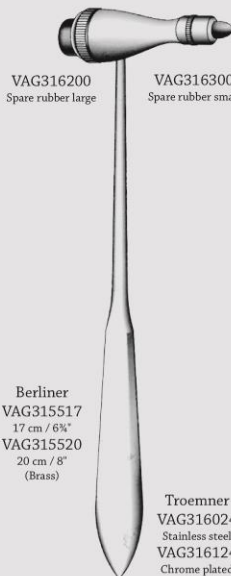
VAG314200
Spare needle only



VAG314700
Spare rubber large



VAG314800
Spare rubber small



VAG316200
Spare rubber large

VAG316300
Spare rubber small



VAG314900
Spare needle only



VAG315000
Spare brush only

Buck
VAG314518
Stainless steel
VAG314618
Chrome plated
(Brass)
18 cm / 7"
With needle and brush

Berliner
VAG315517
17 cm / 6 3/4"
VAG315520
20 cm / 8"
(Brass)

Troemner
VAG316024
Stainless steel
VAG316124
Chrome plated
(Brass)
24.5 cm / 9 3/4"



Traube
VAG316519
Stainless steel
VAG316619
Chrome plated
(Brass)
19 cm / 7 1/2"
190 gm
Wooden handle



Diagnostic
Percussion Hammers
Perkussionshammer
Martillos de percusion

ابزار معاینه
چکش‌های رفلکس



CE

SQS Certificate
ISO 9001:2000
ISO 13485:2003

9



VAG317100
Spare needle only

VAG317200
Spare brush only

Rabiner
VAG317025
Chrome plated
(Brass)
25 cm / 10"
With needle and brush

National Hospital
VAG317535 Rubber ring 50 mm Ø
VAG317635 Rubber ring 60 mm Ø
VAG317735 Rubber ring 70 mm Ø
VAG317835 Plastic handle only
35.5 cm / 14"

Babinski
VAG318023
23 cm / 9"
With plastic handle



Anaesthesia
Catheter Forceps
Katheterzangen
Pinza para cateteres

پنس های مگیل



CE

SQS Certificate
ISO 9001:2000
ISO 13485:2003

10



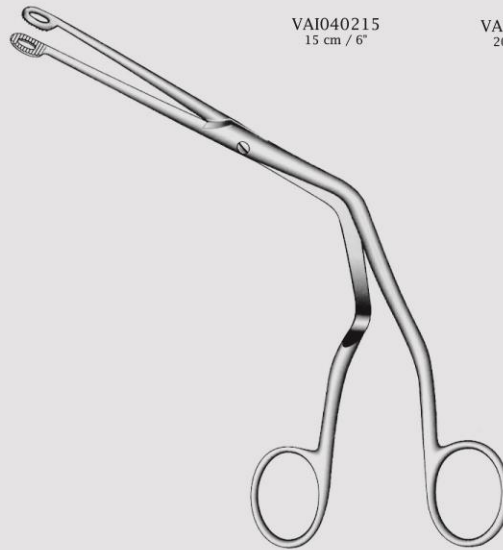
VAI040215
15 cm / 6"



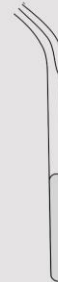
VAI040220
20 cm / 8"



VAI040225
25 cm / 10"



Magill
Catheter introducing forceps



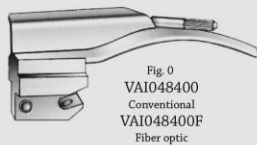


Fig. 0
VAI048400
Conventional
VAI048400F
Fiber optic



Fig. 1
VAI048401
Conventional
VAI048401F
Fiber optic



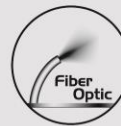
Fig. 2
VAI048402
Conventional
VAI048402F
Fiber optic



Fig. 3
VAI048403
Conventional
VAI048403F
Fiber optic



Fig. 4
VAI048404
Conventional
VAI048404F
Fiber optic



Anaesthesia
Laryngoscopes
Laryngoskope
Laringoscopios

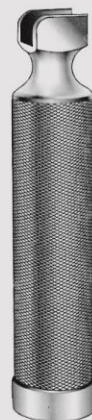
Mc Intosh
VAI048100
Conventional Laryngoscope set with medium handle
Set of 3, fig.1-fig.3
VAI048101
Conventional Laryngoscope set with medium handle
Set of 4, fig.1-fig.4
VAI048100F
Fiber optic laryngoscope set with medium handle
Set of 3, fig.1-fig.3
VAI048101F
Fiber optic laryngoscope set with medium handle
Set of 4, fig.1-fig.4

ابزار معاینه
لارنگسکوپ ها



VAG318500
Spare small handle
Conventional

VAG319000
Spare small handle
Fiber optic



VAG318600
Spare medium handle
Conventional

VAG319100
Spare medium handle
Fiber optic



VAG318700
Spare large handle
Conventional

VAG319200
Spare large handle
Fiber optic



SQS Certificate
ISO 9001:2000
ISO 13485:2003

11



Anaesthesia
Laryngoscopes
Laryngoskope
Laringoscopios

ابزار معاینه
لارنگسکوپ ها



CE

SQS Certificate
ISO 9001:2000
ISO 13485:2003

12



Miller
VAI045200
Conventional Laryngoscope set with medium handle
Set of 3, fig. 1-fig. 3
VAI045201
Conventional Laryngoscope set with medium handle
Set of 4, fig. 1-fig. 4
VAI045200F
Fiber optic laryngoscope set with medium handle
Set of 3, fig. 1-fig. 3
VAI045201F
Fiber optic laryngoscope set with medium handle
Set of 4, fig. 1-fig. 4



Fig. 0
VAI045400
Conventional
VAI045400F
Fiber optic



Fig. 1
VAI045401
Conventional
VAI045401F
Fiber optic



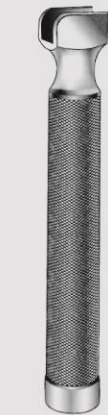
Fig. 2
VAI045402
Conventional
VAI045402F
Fiber optic



Fig. 3
VAI045403
Conventional
VAI045403F
Fiber optic

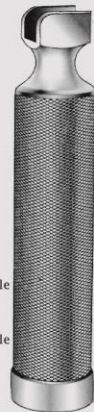


Fig. 4
VAI045404
Conventional
VAI045404F
Fiber optic



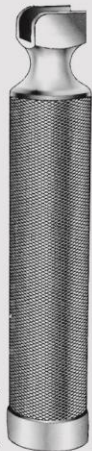
VAG318500
Spare small handle
Conventional

VAG319000
Spare small handle
Fiber optic



VAG318600
Spare medium handle
Conventional

VAG319100
Spare medium handle
Fiber optic



VAG318700
Spare large handle
Conventional

VAG319200
Spare large handle
Fiber optic

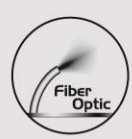


Anaesthesia
Laryngoscopes
Laryngoskope
Laringoscopios

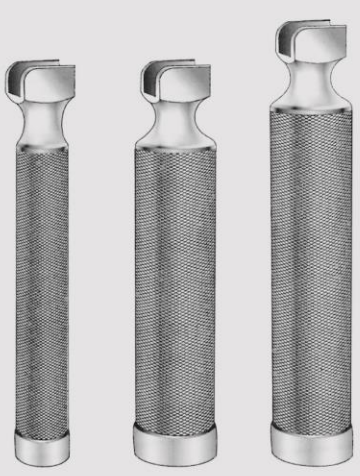
ابزار معاینه
لارنگسکوپ



SQS Certificate
ISO 9001:2000
ISO 13485:2003



Miller-Baby
VAI045300
Conventional Laryngoscope set
with medium handle
VAI045300F
Fiber optic Laryngoscope set
with medium handle



VAG318500 Spare small handle
Conventional
VAG319000 Spare small handle
Fiber optic
VAG318600 Spare medium handle
Conventional
VAG319100 Spare medium handle
Fiber optic
VAG318700 Spare large handle
Conventional
VAG319200 Spare large handle
Fiber optic



Guedel-Negus
VAI046100
Conventional Laryngoscope set with medium handle
Set of 3
VAI046100F
Fiber optic laryngoscope set with medium handle
Set of 3



Anaesthesia
Laryngoscopes
Laryngoskope
Laringoscopios

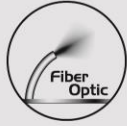
ابزار معاینه
لارنگسکوپ ها



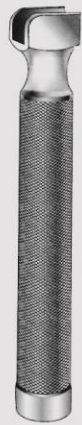
CE

SQS Certificate
ISO 9001:2000
ISO 13485:2003

14



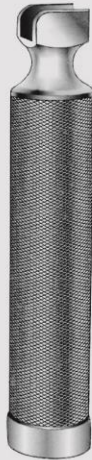
Guedel-Negus
VAI046200
Conventional Laryngoscope set with medium handle
Set of 4
VAI046200F
Fiber optic Laryngoscope set with medium handle
Set of 4



VAG318500
Spare small handle
Conventional



VAG318600
Spare medium handle
Conventional



VAG318700
Spare large handle
Conventional

VAG319000
Spare small handle
Fiber optic

VAG319100
Spare medium handle
Fiber optic

VAG319200
Spare large handle
Fiber optic



Fig 1
VAI046401
Conventional
VAI046401F
Fiber optic

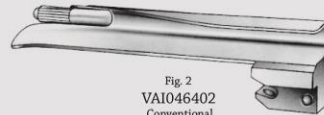


Fig 2
VAI046402
Conventional
VAI046402F
Fiber optic



Fig 3
VAI046403
Conventional
VAI046403F
Fiber optic



Fig 4
VAI046404
Conventional
VAI046404F
Fiber optic



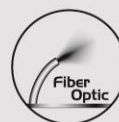
Anaesthesia
Laryngoscopes
Laryngoskope
Laringoscopios

ابزار معاینه
لارنگسکوپ



SQS Certificate
ISO 9001:2000
ISO 13485:2003

15



Foregger
VAI049200
Conventional Laryngoscope set with medium handle
Set of 4
VAI049200F
Fiber optic laryngoscope set with medium handle
Set of 4



Fig. 1
VAI048801
Conventional
VAI048801F
Fiber optic



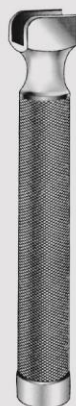
Fig. 2
VAI048802
Conventional
VAI048802F
Fiber optic



Fig. 3
VAI048803
Conventional
VAI048803F
Fiber optic



Fig. 4
VAI048804
Conventional
VAI048804F
Fiber optic



VAG318500
Spare small handle
Conventional



VAG318600
Spare medium handle
Conventional



VAG318700
Spare large handle
Conventional

VAG319000
Spare small handle
Fiber optic

VAG319100
Spare medium handle
Fiber optic

VAG319200
Spare large handle
Fiber optic



Anaesthesia
Blood Pressure Manometers
Blutdruckmessgeräte
Manómetros

ابزار معاینه
فشارسنج ها



CE

SQS Certificate
ISO 9001:2000
ISO 13485:2003

16



VAG319500
Calibrated with velcro cuff
mercury tube 300 mm,
also available with auto lock

VAG319600
Non calibrated with velcro cuff
mercury tube 300 mm,
also available with auto lock

I



VAG320000
Calibrated with velcro cuff, in bag
with manometer
VAG320100
Non calibrated with velcro cuff, in bag
with manometer

www.Diamondmed.ir

DIAMOND SURGICAL
WWW.DIAMONDMED.IR INSTRUMENTS



VAH

Trocars



CE
SQS Certificate
ISO 9001:2000
ISO 13485:2003





Trocars
Trocars
Trocare
Trocares

تروکارها



CE

SQS Certificate
ISO 9001:2000
ISO 13485:2003

18



Universal
VAH300100
Set of 3 pieces
VAH300200
Set of 4 pieces
14 cm / 5½"



Standard
VAH300511 3mm
VAH300611 4mm
VAH300711 5mm
VAH300811 6mm
VAH300911 3.5mm
VAH301011 4.5mm
VAH301111 5.5mm
11 cm / 4¾"



Standard
VAH301512 3mm
VAH301612 4mm
VAH301712 5mm
VAH301812 6mm
VAH301912 3.5mm
VAH302012 4.5mm
VAH302112 5.5mm
12 cm / 4¾"



Standard
VAH302512 3mm
VAH302612 4mm
VAH302712 5mm
VAH302812 6mm
VAH302912 3.5mm
VAH303012 4.5mm
VAH303112 5.5mm
12 cm / 4¾"



Nelson
21 cm / 8¾"



VAH303521



VAH303621



VAH303721



Duke
VAH304011
11 cm / 4½"
5.5 mm





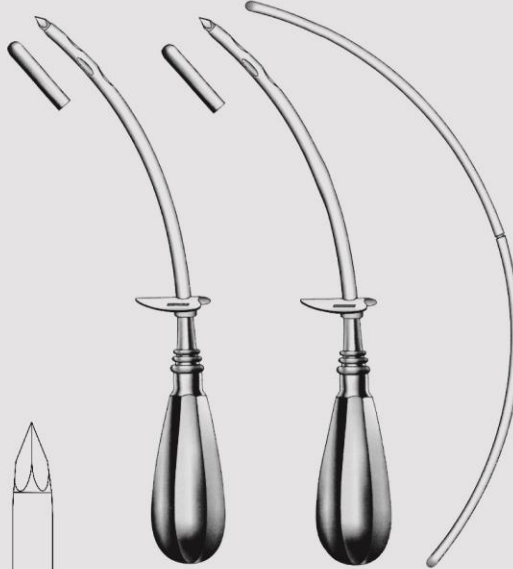
Campbell
16 cm / 6 1/4"



VAH304516
6 mm Ø



VAH304616
8 mm Ø

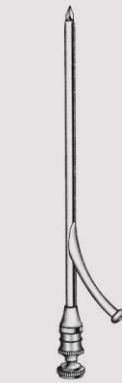


Fleurant
VAH305023
23 cm / 9"
5 mm Ø

Fleurant
VAH30523
23 cm / 9"
5 mm Ø



Buelau
VAH306024
24 cm / 9 1/2"
8 mm Ø



Ochsner
Mod-Surgicon
VAH306514 4 mm Ø
VAH306614 5.5 mm Ø
VAH306714 6.5 mm Ø
14 cm / 5 1/2"



Billroth
VAH307024 5 mm Ø
VAH307124 6 mm Ø
24 cm / 9 1/2"



Trocars
Trocars
Trokare
Trocares

تروکارها



SQS Certificate
ISO 9001:2000
ISO 13485:2003

19



Trocars
Trocars
Trocare
Trocares

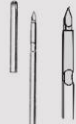
تروکارها



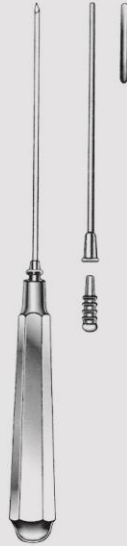
CE

SQS Certificate
ISO 9001:2000
ISO 13485:2003

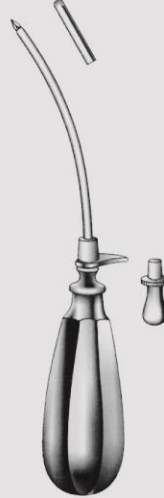
20



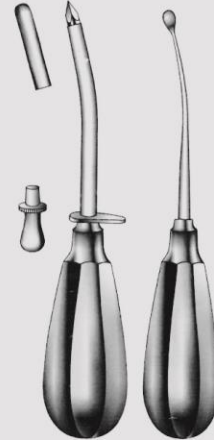
Landau
VAH307500
2 mm



Lichtwitz
VAH059118
1.8 mm



Pierce
VAH059603 3mm
VAH059604 4mm
VAH059605 5mm



Krause
VAH060655
5.5 mm
Antrum trocar,
with obturator and tubing connection



Coakley
VAH061622
2.25 mm
Antrum trocar,
with washing tube and
fixed tubing connection



Douglas
VAH062003
3 mm
Trocar cannula



VAH062111
11 cm / 4 1/4"
Antrum puncture trocar



Suction Tubes
Suction Tubes
Saugrohre
Tubos de aspiracion

سرساكنشن ها

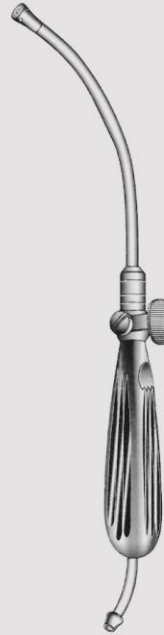


SQS Certificate
ISO 9001:2000
ISO 13485:2003

21



Yankauer
VAH200123 23 cm / 9"
Chrome plated
VAH200227 27 cm / 11"
Chrome plated
VAH064423 23 cm / 9"
Stainless steel
VAH064427 27 cm / 11"
Stainless steel
Without thumb control



Yankauer
VAH200100 Stainless steel
VAH200101 Chrome plated
28 cm / 11"
With thumb control



Pooler
Stainless steel
22 cm / 8 1/2"
VAH308022 8 mmø (Fr 23)
VAH065122 10 mmø (Fr 30)



Pooler
Stainless steel
22 cm / 8 1/2"
VAH065222 8 mmø (Fr 23)
VAH308522 10 mmø (Fr 30)



Suction Tubes
Suction Tubes
Saugrohre
Tubos de aspiracion

سرساكنش ها



CE

SQS Certificate
ISO 9001:2000
ISO 13485:2003

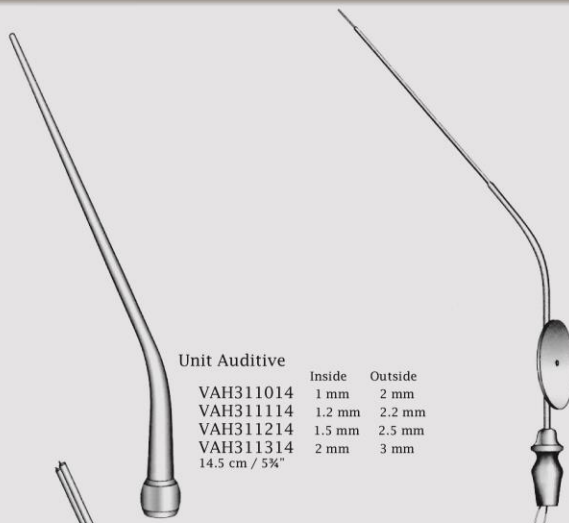
22

Model	Inner Diameter	Length	Notes
VAH067601	1.5 mm \varnothing		
VAH067602	2.0 mm \varnothing		
VAH067603	2.5 mm \varnothing		
VAH067604	3.5 mm \varnothing		
VAH067605	1.5 mm \varnothing		
VAH067606	2.0 mm \varnothing		
VAH067607	2.5 mm \varnothing		
VAH067608	3.5 mm \varnothing		With additional side holes
Adson VAH062221	4 mm \varnothing	21 cm / 8 1/2"	
Frazier	Fr	mm	
VAH062406	06	2	
VAH062407	07	2.3	
VAH062408	08	2.6	
VAH062409	09	3	
VAH062410	10	3.3	
VAH062411	11	3.6	
VAH062412	12	4	
VAH062414	14	4.6	
VAH062416	16	5	
		19 cm / 7 1/2"	
Olive	6.5-9 mm \varnothing	50 mm	With luer hub
Yasargil			
VAH064115	150 mm x 1.5 mm		
VAH064120	150 mm x 2.0 mm		
VAH064125	150 mm x 2.5 mm		
VAH064130	150 mm x 3.5 mm		
		11 cm / 4 3/4"	
Frazier VAH062310	9 fr.	3 mm	

Useable length 150 mm



Suction Tubes
Suction Tubes
Saugrohre
Tubos de aspiracion



Unit Auditive

	Inside	Outside
VAH311014	1 mm	2 mm
VAH311114	1.2 mm	2.2 mm
VAH311214	1.5 mm	2.5 mm
VAH311314	2 mm	3 mm

14.5 cm / 5 3/4"

Baron

VAH313000	3 French
VAH313100	5 French
VAH313200	7 French



**House Suction
Irrigating Tubes**

VAH311500	5 French
VAH311600	7 French
VAH311700	8 French
VAH311800	10 French
VAH311900	12 French
VAH312000	14 French

Ear suction tube



Baron

VAH312500	3 French
VAH312600	5 French
VAH312700	7 French

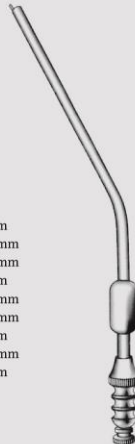
With finger cut off



Frazier

VAH309000	6 Fr	2 mm
VAH309100	7 Fr	2.3 mm
VAH309200	8 Fr	2.6 mm
VAH309300	9 Fr	3 mm
VAH309400	10 Fr	3.3 mm
VAH309500	11 Fr	3.6 mm
VAH309600	12 Fr	4 mm
VAH309700	14 Fr	4.6 mm
VAH309800	16 Fr	5 mm

Ear suction tube



Frazier

VAH310000	6 Fr	2 mm
VAH310100	7 Fr	2.3 mm
VAH310200	8 Fr	2.6 mm
VAH310300	9 Fr	3 mm
VAH310400	10 Fr	3.3 mm
VAH310500	11 Fr	3.6 mm
VAH310600	12 Fr	4 mm
VAH310700	14 Fr	4.6 mm
VAH310800	16 Fr	5 mm

سرساكنشن ها



CE

SQS Certificate
ISO 9001:2000
ISO 13485:2003

23



Suction Tubes
Guide Needles
Führungsnadeln
Agujas de guía

سرساكنشن ها



CE

SQS Certificate
ISO 9001:2000
ISO 13485:2003

24



Redon
19.5 cm / 7 7/8"
Slightly curved
knife tip, threaded end

- VAH313519 8 Charr.
- VAH313619 10 Charr.
- VAH313719 12 Charr.
- VAH313819 14 Charr.
- VAH313919 16 Charr.
- VAH314019 18 Charr.



Redon
19.5 cm / 5 3/4"
Fully curved
knife tip, threaded end

- VAH314519 8 Charr.
- VAH314619 10 Charr.
- VAH314719 12 Charr.
- VAH314819 14 Charr.
- VAH314919 16 Charr.
- VAH315019 18 Charr.



Redon
19.5 cm / 7 7/8"
Slightly curved
lancet tip, threaded end

- VAH315519 8 Charr.
- VAH315619 10 Charr.
- VAH315719 12 Charr.
- VAH315819 14 Charr.
- VAH315919 16 Charr.
- VAH316019 18 Charr.

DIAMOND SURGICAL
WWW.DIAMONDMED.IR INSTRUMENTS



VAZ
Handles and Knives



CE

SQS Certificate
ISO 9001:2000
ISO 13485:2003

25

www.Diamondmed.ir



Handles
 Scalpel Handles
 Skalpell-Griffe
 Mangos de bisturios

دسته بیستوری



CE
 SQS Certificate
 ISO 9001:2000
 ISO 13485:2003

26



Standard
 VAZ023103
 No. 3
 Solid

VAZ023105
 No. 3
 Solid, with scale

VAZ023104
 No. 3
 Solid

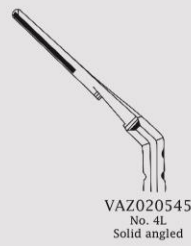
VAZ021304
 No. 3
 Plastics

VAZ023431
 No. 3L
 Solid straight

VAZ023435
 No. 3L
 Solid angled



Handles
 Scalpel Handles
 Skalpell-Griffe
 Mangos de bisturios



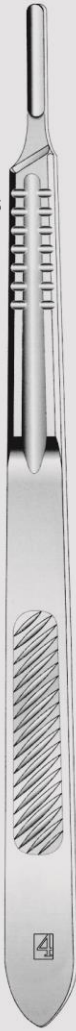
Standard
 VAZ020104
 No. 4
 Solid



VAZ300100
 No. 4
 Graduated in mm



VAZ024303
 No. 4
 Plastics



VAZ020541
 No. 4L
 Solid straight



VAZ300500
 No. 7
 Long



VAZ023807
 No. 7
 Solid



VAZ023871
 No. 7K
 Solid



VAZ301000
 No. 5
 Solid

دسته بیستوری



SQS Certificate
 ISO 9001:2000
 ISO 13485:2003

27



Handles
Scalpel Handles
Skalpelli-Griffe
Mangos de bisturias

دسته بیستوری



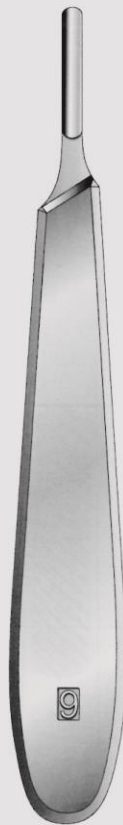
CE

SQS Certificate
ISO 9001:2000
ISO 13485:2003

28



Collin
VAZ301500
13.5 cm / 5 1/4"
No. 8
Hollow



Collin
VAZ302000
14.5 cm / 5 3/4"
No. 9
Hollow



VAZ302500
No. 10
Hollow



Handles
Scalpel Handles
Skalpell-Griffe
Mangos de bisturios



VAZ024703
14.5 cm / 5 3/4"
No. 3
Solid, round, straight



VAZ024803
14 cm / 5 1/2"
No. 3
Solid round angled



VAZ024103
15.5 cm / 6"
No. 3
Round hollow handle
straight



VAZ200103
No. 3
Round hollow handle
angled



VAZ303015
15.5 cm / 6 1/4"
No. 3
Hollow golden handle

دسته بیستوری



CE

SQS Certificate
ISO 9001:2000
ISO 13485:2003

29



Handles
Razor Blade Holders (and Breakers)
Rasierklingshalter und-brecher
sujetar y romper hojas de afeitador
Pinzas para

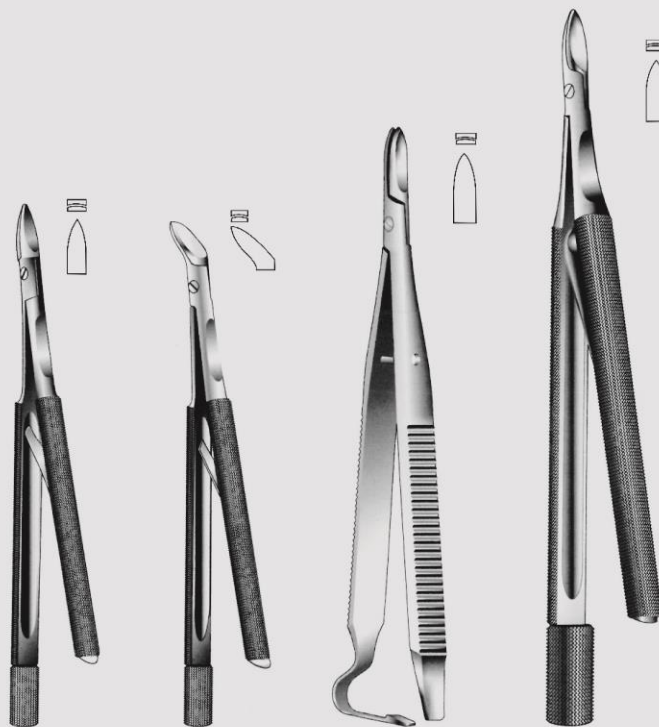
دسته بیستوری



CE

SQS Certificate
ISO 9001:2000
ISO 13485:2003

30



Troutman Chris
VAZ303510
10 cm / 4"
5.5 mm

Troutman Chris
VAZ304010
10 cm / 4"
5.5 mm

VAZ304511
11 cm / 4½"

Castroviejo
VAZ305013
13 cm / 5¼"
8 mm



Knives
 Dissecting Knives
 Anatomische Skalpell
 Bisturies para diseccion
 anatomica



Solid
Plain handle



VAZ305500
Plain handle
VAZ307000
Grooved handle
Fig. 1
15 cm / 6"



VAZ305600
Plain handle
VAZ307100
Grooved handle
Fig. 2
15 cm / 6"



VAZ305700
Plain handle
VAZ307200
Grooved handle
Fig. 3
15.5 cm / 6"



VAZ305800
Plain handle
VAZ307300
Grooved handle
Fig. 4
16 cm / 6¼"



VAZ305900
Plain handle
VAZ307400
Grooved handle
Fig. 5
16 cm / 6¼"



VAZ306000
Plain handle
VAZ307500
Grooved handle
Fig. 6
15 cm / 6"



VAZ306100
Plain handle
VAZ307600
Grooved handle
Fig. 7
15 cm / 6"



VAZ306200
Plain handle
VAZ307700
Grooved handle
Fig. 8
16 cm / 6¼"



VAZ306300
Plain handle
VAZ307800
Grooved handle
Fig. 9
16 cm / 6¼"



VAZ306400
Plain handle
VAZ307900
Grooved handle
Fig. 10
17 cm / 6¾"



Solid
Grooved handle

چاقو ها



CE

SQS Certificate
ISO 9001:2000
ISO 13485:2003

31



Knives
Dissecting Knives
Anatomische Skalpelle
Bisturios para
diseccion anatomica

چاقو ها



CE

SQS Certificate
ISO 9001:2000
ISO 13485:2003

32



VAZ308514
14 cm / 5½"



VAZ308614
14.5 cm / 5¾"



VAZ308715
15 cm / 6"



VAZ308815
15.5 cm / 6"



VAZ308916
16 cm / 6¼"



VAZ309016
16.5 cm / 6½"



VAZ309117
17 cm / 6¾"



VAZ309217
17.5 cm / 7"



VAZ309318
18 cm / 7"



VAZ309418
18 cm / 7"



Knives
Dissecting Knives
Antomische Skalpelle
Bisturies para diseccion
anatomica



VAZ310014
14 cm / 5½"



VAZ310114
14.5 cm / 5¾"



VAZ310215
15 cm / 6"



VAZ310315
15.5 cm / 6"



VAZ310416
16 cm / 6¾"



VAZ310516
16.5 cm / 6½"



VAZ310617
17 cm / 6¾"



VAZ310717
17.5 cm / 7"



VAZ310817
17 cm / 6¾"



VAZ310917
17 cm / 6¾"



چاقوها



CE

SQS Certificate
ISO 9001:2000
ISO 13485:2003

33



Knives
Dissecting Knives
Anatomische Skalpelle
Bisturies para
diseccion anatomica

چاقو ها



CE

SQS Certificate
ISO 9001:2000
ISO 13485:2003

34



Collin



VAZ311500



VAZ311600



VAZ311700



VAZ311800



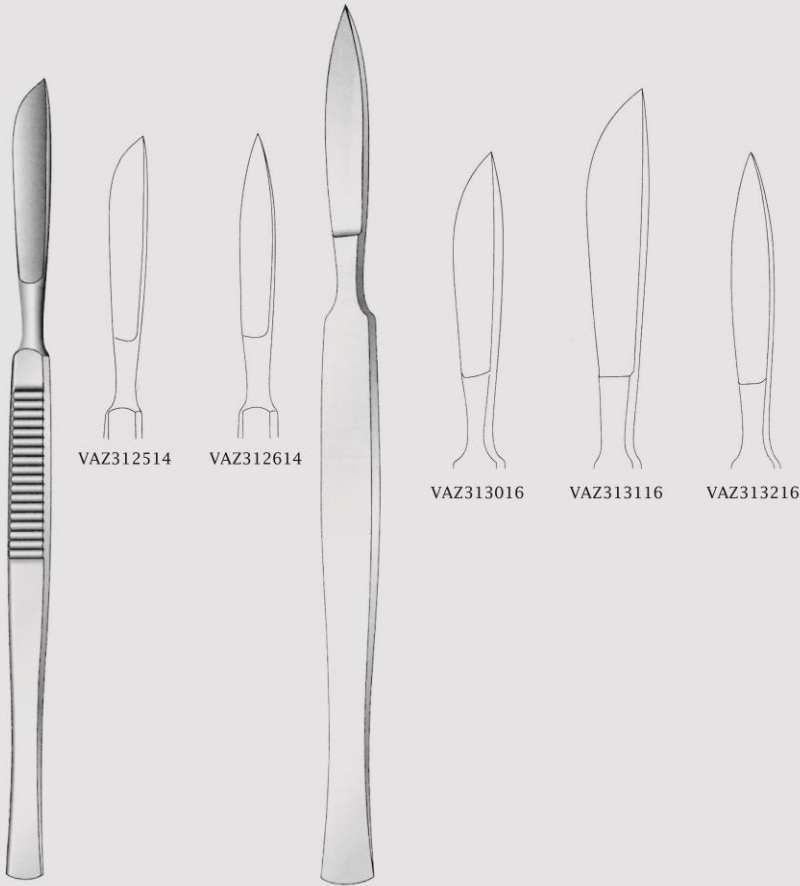
VAZ311900



VAZ312000



Knives
Dissecting Knives
Anatomische Skalpelle
Bisturíes para disección
anatomica



Bergmann
14 cm / 5 1/2"

16 cm / 6 1/4"

چاقو ها



CE

SQS Certificate
ISO 9001:2000
ISO 13485:2003

35



Knives

Resection Knives, Razors
Resektionsmesser, Rasiermesser
Cuchillos para reseccion, Navajas

چاقو ها



CE

SQS Certificate
ISO 9001:2000
ISO 13485:2003

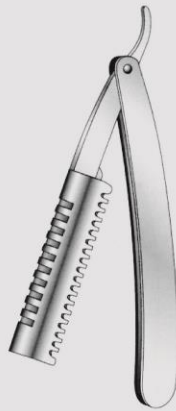
36



Langenbeck
VAZ313500



Langenbeck
VAZ314000



VAZ314500
Razor for interchangeable
blades, with safety clip



VAZ315000



VAZ315500



VAZ316000



VAZ316500



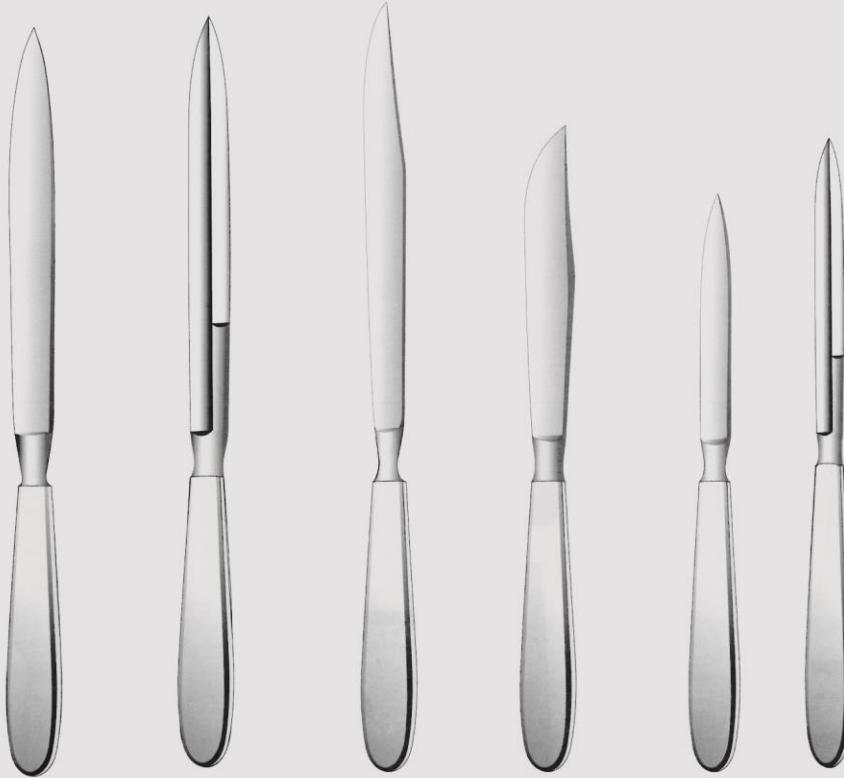
Virchow
VAZ317000



Virchow
VAZ317525
25 cm / 10"



Knives
Amputating Knives
Amputationsmesser
Cuchillos para amputacion



Catlin		Liston		Langenbeck		VAZ320009		VAZ320511	
VAZ318013	13 cm / 5"	VAZ318516	16 cm / 6 1/4"	VAZ319017	17 cm / 6 3/4"	VAZ319512	12 cm / 4 3/4"	VAZ320009	9.5 cm / 3 3/4"
VAZ318016	16 cm / 6 1/4"	VAZ318519	19 cm / 7 1/2"	VAZ319020	20 cm / 8"	VAZ319518	18 cm / 7"	VAZ320511	11 cm / 4 1/2"
VAZ318019	19 cm / 7 1/2"	VAZ318522	22 cm / 8 3/4"						
VAZ318022	22 cm / 8 3/4"	VAZ318529	29 cm / 11 1/2"						
VAZ318028	28 cm / 11 1/4"								
VAZ318032	32.5 cm / 12 3/4"								

چاقو ها



CE

SQS Certificate
ISO 9001:2000
ISO 13485:2003

37



Knives

Post Mortem Knives, Brain Knives
Organmesser, Hirnmesser
Cuchillos para organos Y cerebro

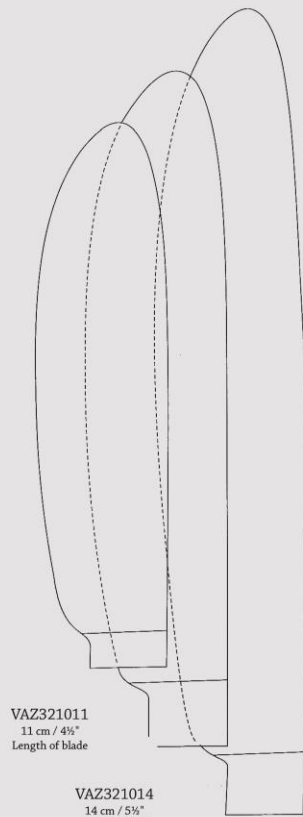
چاقو ها



CE

SQS Certificate
ISO 9001:2000
ISO 13485:2003

38



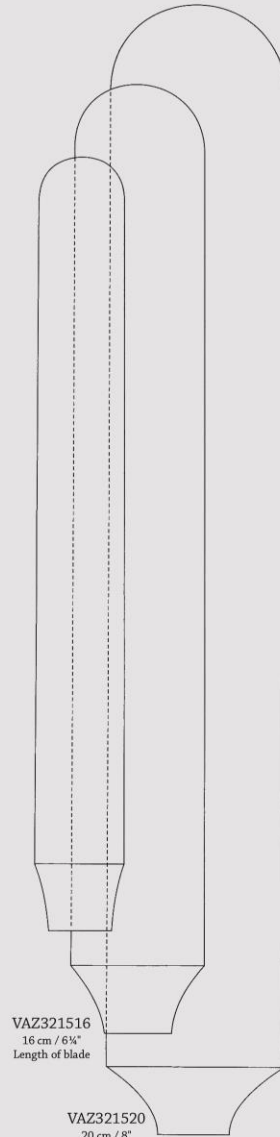
VAZ321011
11 cm / 4 1/2"
Length of blade

VAZ321014
14 cm / 5 1/2"
Length of blade

VAZ321017
17 cm / 6 3/4"
Length of blade



Walb



VAZ321516
16 cm / 6 3/4"
Length of blade

VAZ321520
20 cm / 8"
Length of blade

VAZ321524
24 cm / 9 1/2"
Length of blade



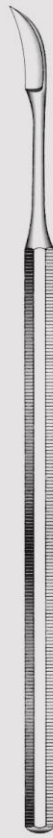
Virchow



Knives
Gum Knives
Zahnfleischmesser
Bisturies para encías



Ash
VAZ015101
Fig. 1



Ash
VAZ015102
Fig. 2



Ash
VAZ015103
Fig. 3

چاقو ها



CE

SQS Certificate
ISO 9001:2000
ISO 13485:2003

39



Knives
Dermatomes
Dermatome
Dermatomos

دسته دراماتوم ها



CE

SQS Certificate
ISO 9001:2000
ISO 13485:2003

40



Skin Grape Set
31 cm / 12 1/4"
VAZ322031
Without box
VAZ322131
In wooden box



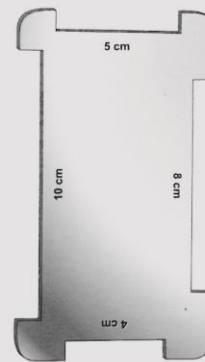
Schink
30 cm / 12"
VAZ322530
Dermatome, adjustable from 0.1 to 2.0 mm,
complete with 1 interchangeable blade and
2 skin straightening blade
VAZ322630
Wooden box



Silver
19 cm / 7 1/2"
VAZ323019
VAZ323119
In wooden box



Schink
VAZ323500
Spare blade only



Schink
VAZ324000
Skin straightening plate only

DIAMOND SURGICAL
WWW.DIAMONDMED.IR INSTRUMENTS



VAA
Scissors



CE

SQS Certificate
ISO 9001:2000
ISO 13485:2003

41



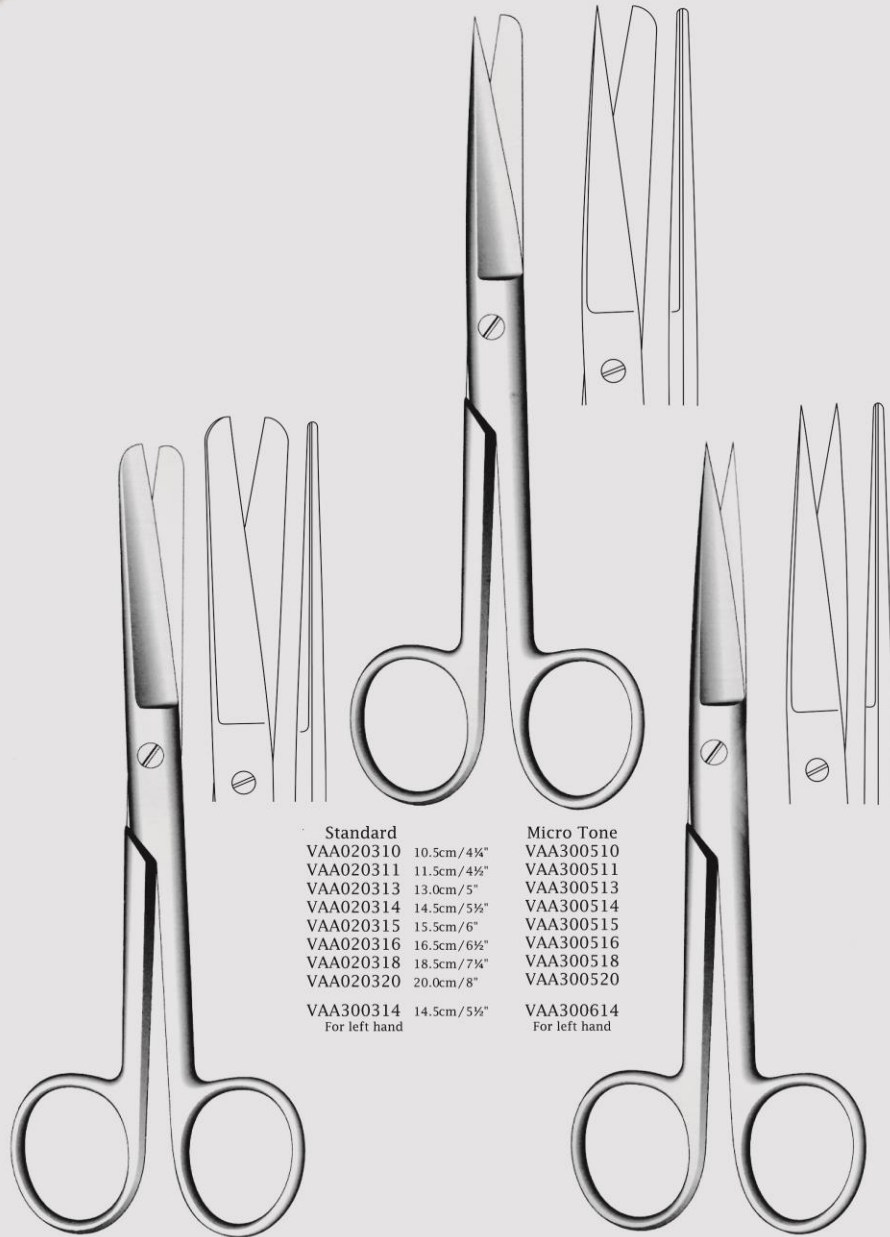
Scissors
 Operating Scissors
 Chirurgische Scheren
 Tijeras Para Cirugia

قیچی ها



CE
 SQS Certificate
 ISO 9001:2000
 ISO 13485:2003

42



Standard	
VAA020310	10.5cm / 4 1/4"
VAA020311	11.5cm / 4 1/2"
VAA020313	13.0cm / 5"
VAA020314	14.5cm / 5 1/2"
VAA020315	15.5cm / 6"
VAA020316	16.5cm / 6 1/2"
VAA020318	18.5cm / 7 1/4"
VAA020320	20.0cm / 8"
VAA300314	14.5cm / 5 1/2"
For left hand	

Micro Tone	
VAA300510	
VAA300511	
VAA300513	
VAA300514	
VAA300515	
VAA300516	
VAA300518	
VAA300520	
VAA300614	
For left hand	

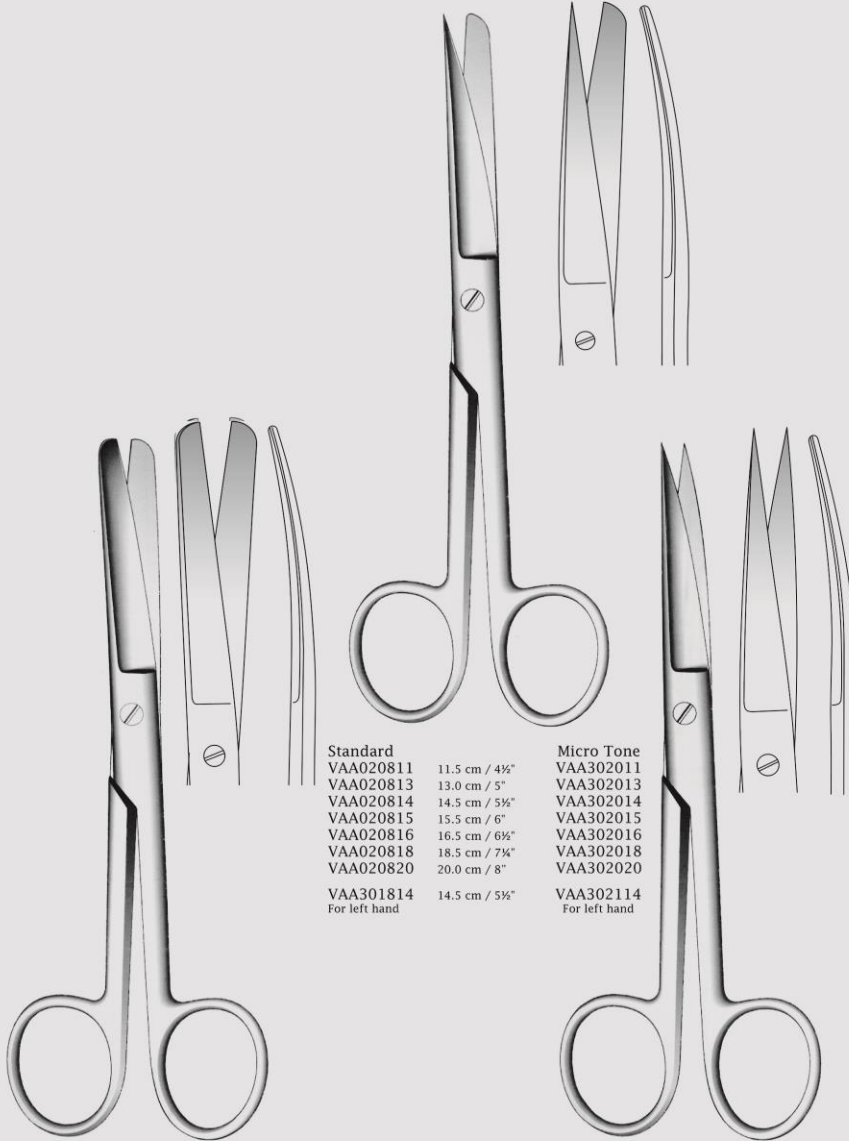
Standard	Micro Tone
VAA020110	VAA300110
VAA020111	VAA300111
VAA020113	VAA300113
VAA020114	VAA300114
VAA020115	VAA300115
VAA020116	VAA300116
VAA020118	VAA300118
VAA020120	VAA300120

Standard	Micro Tone
VAA020510	VAA301010
VAA020511	VAA301011
VAA020513	VAA301013
VAA020514	VAA301014
VAA020515	VAA301015
VAA020516	VAA301016
VAA020518	VAA301018
VAA020520	VAA301020



Scissors
Operating Scissors
Chirurgische Scheren
Tijeras Para Cirugia

قیچی ها



Standard

VAA020811	11.5 cm / 4½"
VAA020813	13.0 cm / 5"
VAA020814	14.5 cm / 5½"
VAA020815	15.5 cm / 6"
VAA020816	16.5 cm / 6½"
VAA020818	18.5 cm / 7¼"
VAA020820	20.0 cm / 8"

Micro Tone

VAA302011	
VAA302013	
VAA302014	
VAA302015	
VAA302016	
VAA302018	
VAA302020	

VAA301814	14.5 cm / 5½"
For left hand	

VAA302114	
For left hand	

Standard

VAA020611	11.5 cm / 4½"
VAA020613	13.0 cm / 5"
VAA020614	14.5 cm / 5½"
VAA020615	15.5 cm / 6"
VAA020616	16.5 cm / 6½"
VAA020618	18.5 cm / 7¼"
VAA020620	20.0 cm / 8"

Micro Tone

VAA301511	
VAA301513	
VAA301514	
VAA301515	
VAA301516	
VAA301518	
VAA301520	

Standard

VAA021011	11.5 cm / 4½"
VAA021013	13.0 cm / 5"
VAA021014	14.5 cm / 5½"
VAA021015	15.5 cm / 6"
VAA021016	16.5 cm / 6½"
VAA021018	18.5 cm / 7¼"
VAA021020	20.0 cm / 8"

Micro Tone

VAA302511	
VAA302513	
VAA302514	
VAA302515	
VAA302516	
VAA302518	
VAA302520	



SQS Certificate
ISO 9001:2000
ISO 13485:2003

43



Scissors
Operating Scissors
Chirurgische Scheren
Tijeras Para Cirugia

قیچی ها



CE
SQS Certificate
ISO 9001:2000
ISO 13485:2003

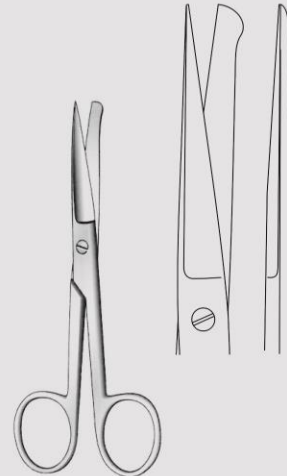


Deaver
14 cm / 5½"

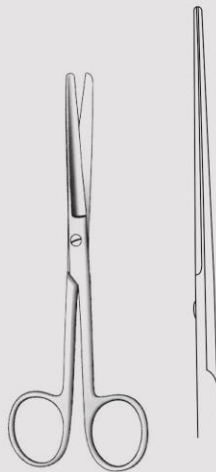


VAA303014
Straight

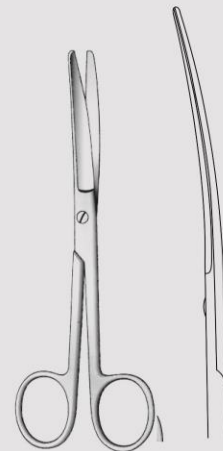
VAA303114
Curved



Incision
VAA303513 4" / 13 cm / 5"
VAA303514 14 cm / 5½"



Grazil
VAA304014 Blunt/Blunt
VAA304114 Sharp/Blunt
VAA304214 Sharp/Sharp
14 cm / 5½"



Grazil
VAA304514 Blunt/Blunt
VAA304614 Sharp/Blunt
VAA304714 Sharp/Sharp
14 cm / 5½"



Scissors
 Operating & Gynecological Scissors
 Chirurgische Gynakologie scheren
 Tijeras Para Cirugia & Ginecologia



Mayo

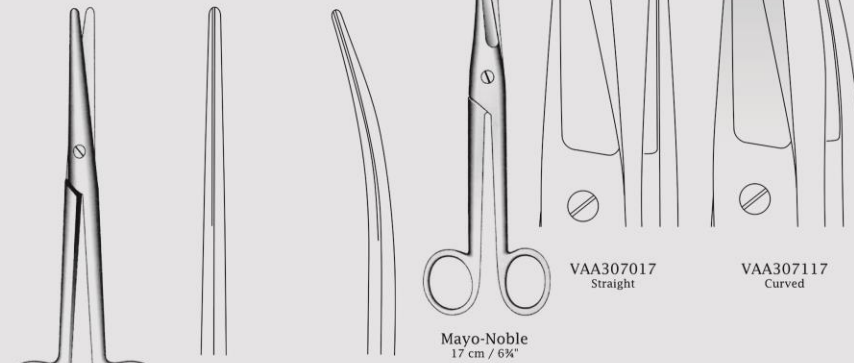
VAA027114 14 cm / 5 3/4"
 VAA027115 15 cm / 6"
 VAA027117 17 cm / 6 3/4"
 VAA027123 23 cm / 9"
 Straight

VAA027214
 VAA027215
 VAA027217
 VAA027223
 Curved

Mayo Harrington

VAA305022 22.5 cm / 9"
 VAA305030 30 cm / 12"
 Straight

VAA305522
 VAA305530
 Curved



Mayo Stille

VAA306015 15 cm / 6"
 VAA306016 16 cm / 6 3/4"
 VAA306017 17 cm / 6 3/4"
 VAA306019 19 cm / 7 1/2"
 VAA306021 21 cm / 8 1/2"
 Straight

VAA306515
 VAA306516
 VAA306517
 VAA306519
 VAA306521
 Curved

Mayo-Noble
 17 cm / 6 3/4"

VAA307017
 Straight

VAA307117
 Curved

قیچی ها



CE

SQS Certificate
 ISO 9001:2000
 ISO 13485:2003

45



Scissors

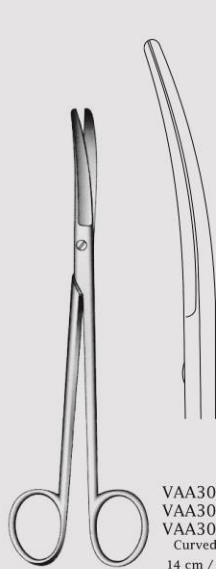
Operating & Gynecological Scissors
Chirurgische Gynakologie scheren
Tijeras Para Cirugia & Ginecologia

قیچی ها



SQS Certificate
ISO 9001:2000
ISO 13485:2003

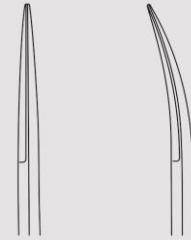
46



VAA307514
VAA307519
VAA307522
Curved
14 cm / 5½"
19 cm / 7¼"
22.5 cm / 8¾"



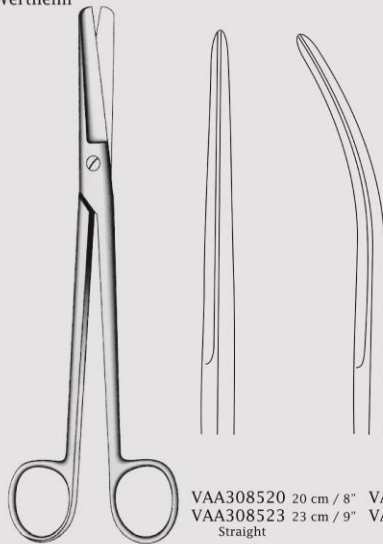
Siebold
VAA308024
24 cm / 9½"



VAA032716 16 cm / 6½" VAA032816
VAA032718 18 cm / 7" VAA032818
Straight Curved

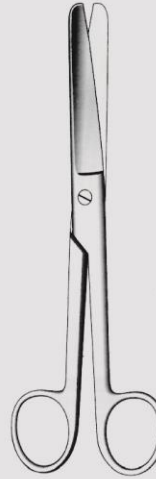
Kelly

Wertheim



Sims

VAA308520 20 cm / 8" VAA309020
VAA308523 23 cm / 9" VAA309023
Straight Curved



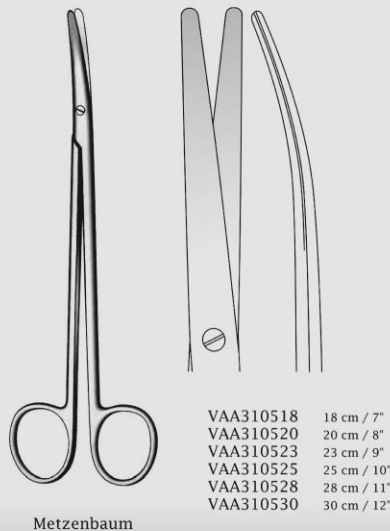
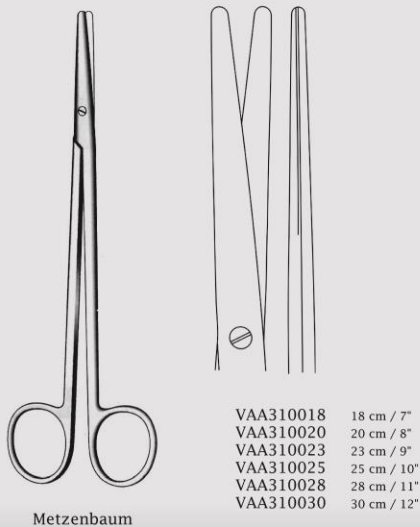
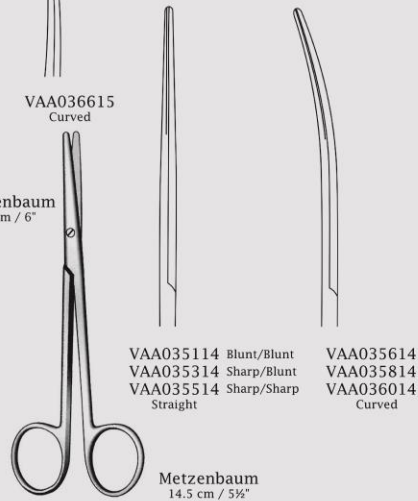
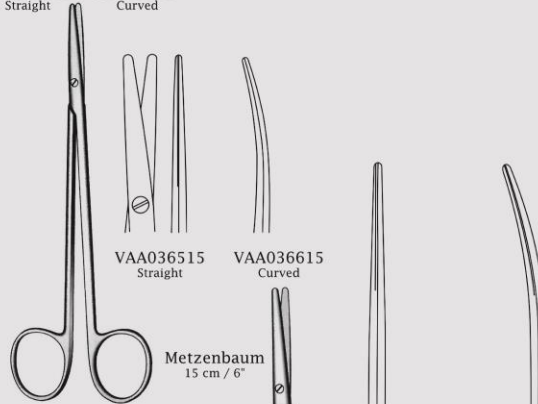
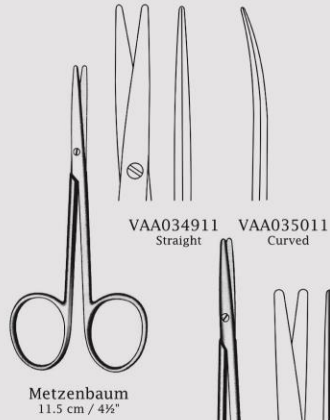
Doyen
18 cm / 7"

VAA309518
Straight

VAA309618
Curved



Scissors
Dissecting Scissors
Preparierscheren
Tijeras Para Preparaciones



قیچی ها



CE

SQS Certificate
ISO 9001:2000
ISO 13485:2003

47



Scissors
Dissecting Scissors
Praparierscheren
Tijeras Para Preparaciones

قیچی ها



CE
SQS Certificate
ISO 9001:2000
ISO 13485:2003

48

Metzenbaum-Nelson

VAA311018	18 cm / 7"
VAA311020	20 cm / 8"
VAA311023	23 cm / 9"
VAA311025	25 cm / 10"
VAA311028	28 cm / 11"
VAA311030	30 cm / 12"

Metzenbaum-Nelson

VAA311518	18 cm / 7"
VAA311520	20 cm / 8"
VAA311523	23 cm / 9"
VAA311525	25 cm / 10"
VAA311528	28 cm / 11"
VAA311530	30 cm / 12"

Metzenbaum-Nelson

VAA312018	18 cm / 7"
VAA312020	20 cm / 8"
VAA312023	23 cm / 9"
VAA312025	25 cm / 10"
VAA312028	28 cm / 11"
VAA312030	30 cm / 12"

Metzenbaum-Nelson

VAA312518	18 cm / 7"
VAA312520	20 cm / 8"
VAA312523	23 cm / 9"
VAA312525	25 cm / 10"
VAA312528	28 cm / 11"
VAA312530	30 cm / 12"

Metzenbaum-Nelson

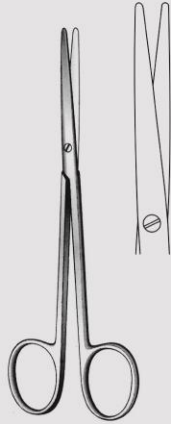
Lexer

VAA313016	16 cm / 6 1/4"	VAA313516
VAA313021	21 cm / 8 1/2"	VAA313521
Straight		Curved



Scissors

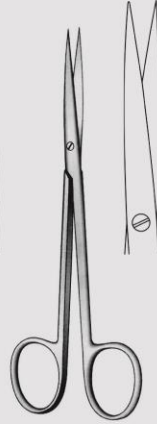
Dissecting Scissors, Fino-Line
Preparierscheren, Fino-Linie
Tijeras Para Preparaciones, Linea-Fino



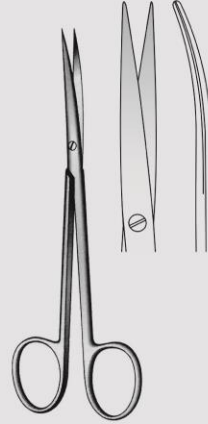
Metzenbaum-Fino
VAA042714 14.5 cm / 5 1/2"
VAA042718 18 cm / 7"
VAA042720 20 cm / 8"
VAA042723 23 cm / 9"
Slender pattern



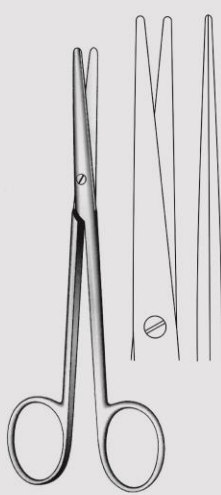
Metzenbaum-Fino
VAA042814 14.5 cm / 5 1/2"
VAA042818 18 cm / 7"
VAA042820 20 cm / 8"
VAA042823 23 cm / 9"
Slender pattern



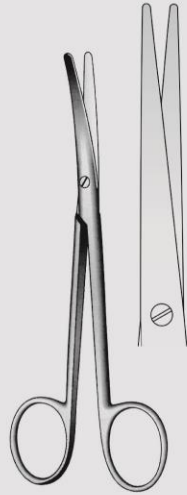
Metzenbaum-Fino
VAA042914 14.5 cm / 5 1/2"
VAA042918 18 cm / 7"
VAA042920 20 cm / 8"
VAA042923 23 cm / 9"
Slender pattern



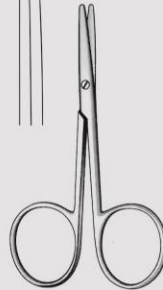
Metzenbaum-Fino
VAA043014 14.5 cm / 5 1/2"
VAA043018 18 cm / 7"
VAA043020 20 cm / 8"
VAA043023 23 cm / 9"
Slender pattern



Lexer-Fino
VAA314016
16 cm / 6 1/4"
Slender pattern



Lexer-Fino
VAA314516
16 cm / 6 1/4"
Slender pattern



Lexer-Baby
10 cm / 4"



VAA315010
Straight



VAA315110
Curved

قیچی ها



SQS Certificate
ISO 9001:2000
ISO 13485:2003



Scissors

Thorax and Vascular Scissors
Thoraxscheren, Gefabscheren
Tijeras toracicas Y Vasculares

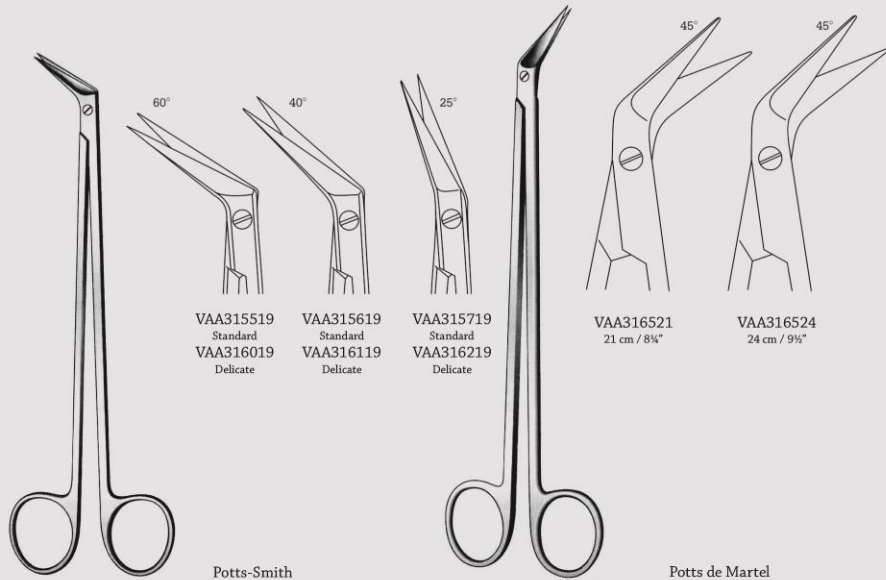
قیچی ها



CE

SQS Certificate
ISO 9001:2000
ISO 13485:2003

50



VAA315519
Standard
VAA316019
Delicate

VAA315619
Standard
VAA316119
Delicate

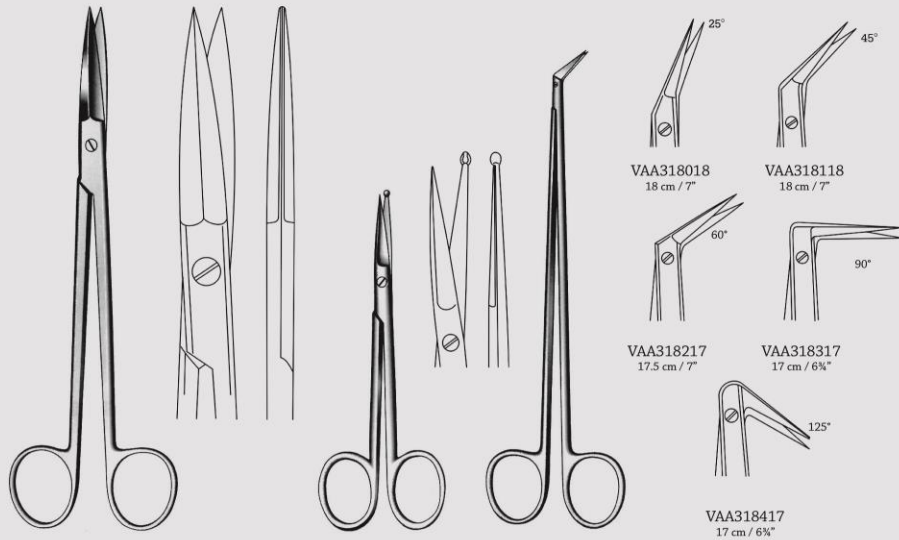
VAA315719
Standard
VAA316219
Delicate

VAA316521
21 cm / 8 1/4"

VAA316524
24 cm / 9 1/2"

Potts-Smith
19 cm / 7 1/2"

Potts de Martel



Mc-Indoe
VAA317019
19 cm / 7 1/2"

VAA317511
11.5 cm / 4 1/2"

Dietrich

VAA318018
18 cm / 7"

VAA318118
18 cm / 7"

VAA318217
17.5 cm / 7"

VAA318317
17 cm / 6 3/4"

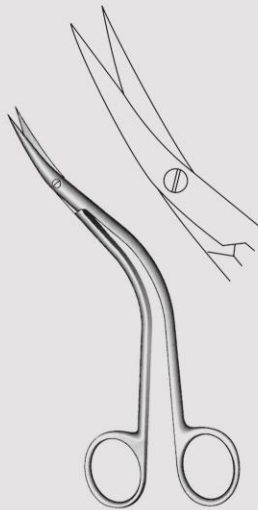
VAA318417
17 cm / 6 3/4"



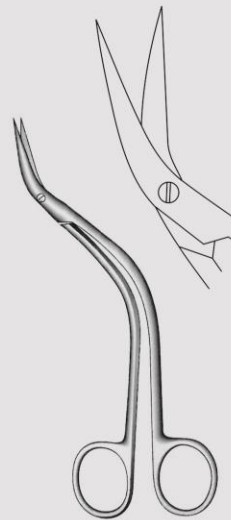
Scissors
Thorax and Vascular Scissors
Thoraxscheren, Gefäßscheren
Tijeras toracicas y vasculares



Favaloro
VAA320015
15 cm / 6"



De Bakey
VAA320515
15.5 cm / 6"



De Bakey
VAA321015
15.5 cm / 6"

قیچی ها



CE

SQS Certificate
ISO 9001:2000
ISO 13485:2003

51



Scissors

Thorax and Vascular Scissors
Thoraxscheren, Gefabscheren
Tijeras toracicas Y Vasculares

قیچی ها



CE

SQS Certificate
ISO 9001:2000
ISO 13485:2003

52



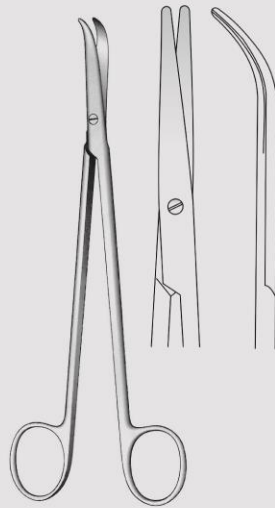
Crafoord
VAA321530
30 cm / 12"

Satinsky
VAA322024
24.5 cm / 10"

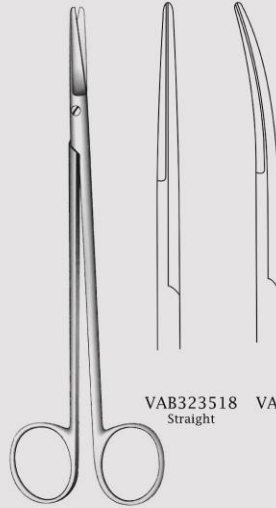
Klinkenbergh-Loth
VAA322523
23 cm / 9"



Scissors
Neurosurgical Scissors
Scheren für Neurochirurgie
Tijeras para cirugía
neurocirugía

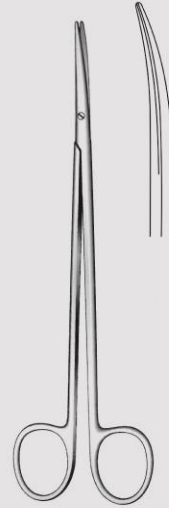


Thorek
VAA323018
18 cm / 7"

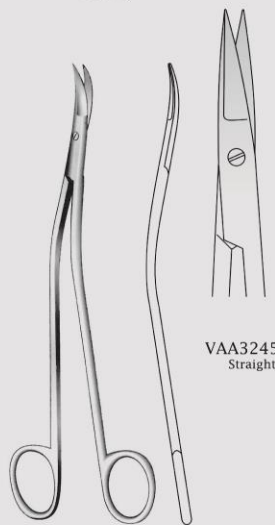


VAB323518 VAA323618
Straight Curved

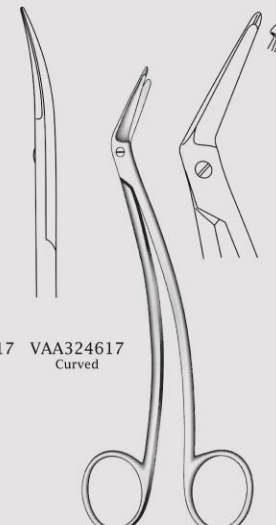
Toennis
18 cm / 7"



Toennis-Adson
VAA324017
17.5 cm / 7"

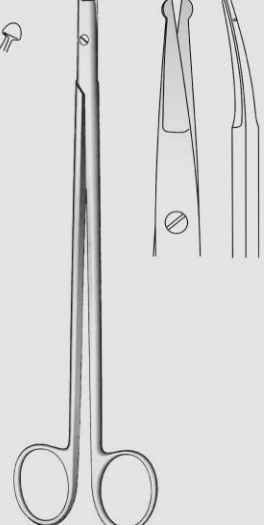


Dandy
17 cm / 6 3/4"



VAA324517 VAA324617
Straight Curved

Schmieden-Taylor
VAA325017
17 cm / 6 3/4"



Strully
VAA325522
22 cm / 8 1/2"
Curved

قیچی ها



CE

SQS Certificate
ISO 9001:2000
ISO 13485:2003

53



Scissors
Tonsil and Nasal Scissors
Tonsillen- und Nasenschere
Tijeras nasales Y para amígdalas

قیچی ها



CE

SQS Certificate
ISO 9001:2000
ISO 13485:2003

54



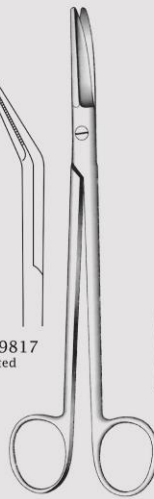
Dean
17 cm / 6 3/4"



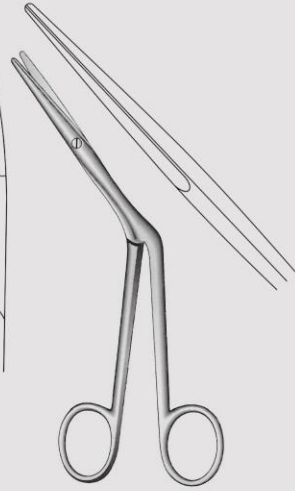
VAA059611
Plain



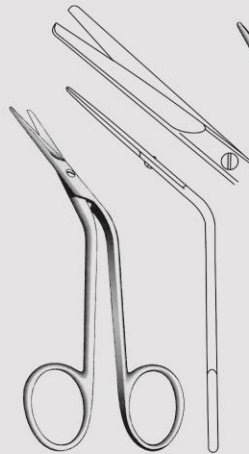
VAA059817
Serrated



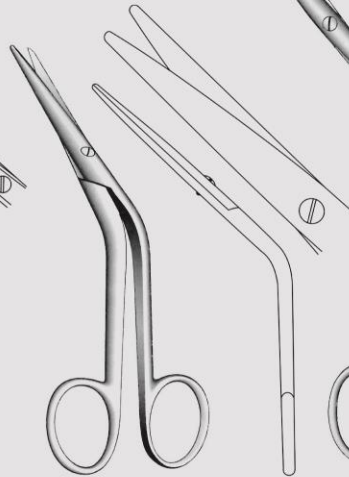
Boettcher
VAA326018
18 cm / 7"



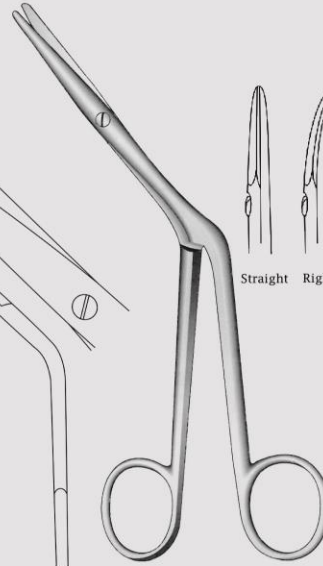
Heymann
VAA326518
18 cm / 7"



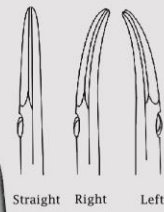
Fomon
VAA327015
15 cm / 6"



Cottle
VAA327516
16 cm / 6 1/2"



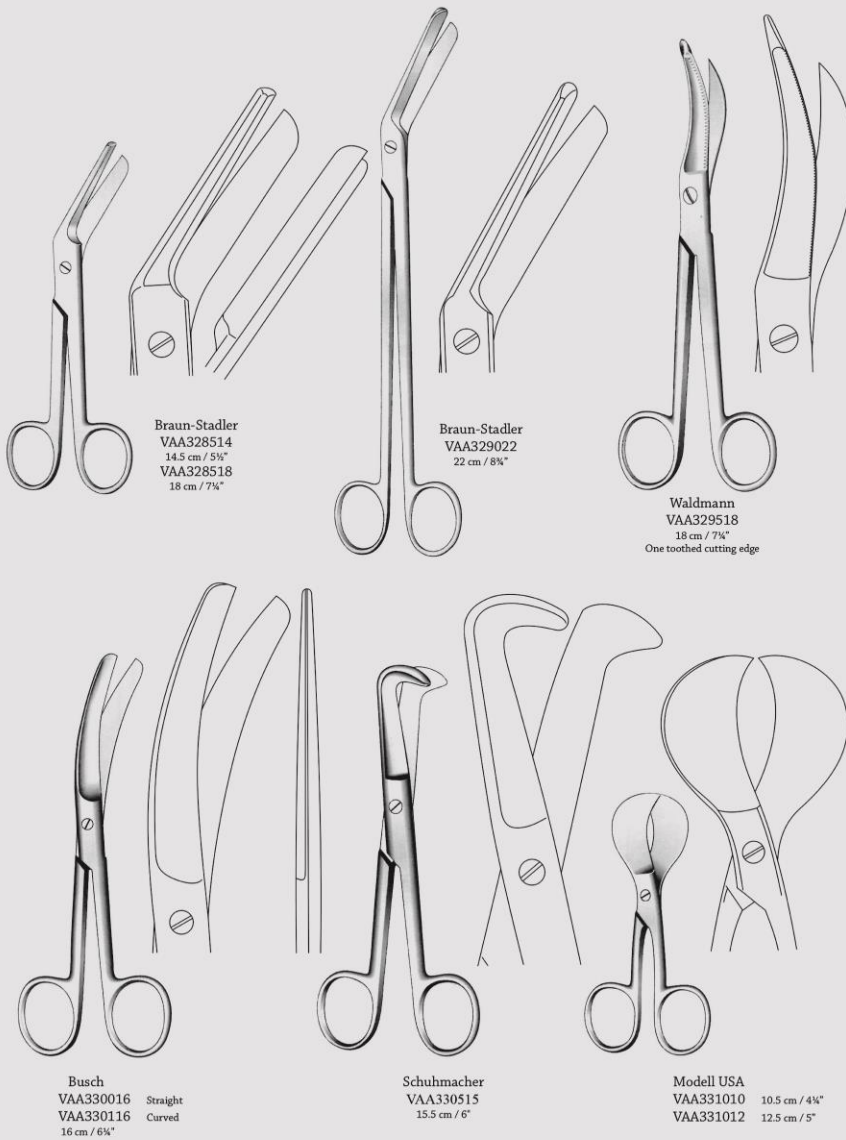
Knight
VAA328018 Straight
VAA328118 Curved left, serrated
VAA328218 Curved right, serrated
18 cm / 7"





Scissors

Episiotomy And Umbilical Scissors
Episiotomie Und Nabelschnur-Scheren
Tijeras Para Episiotomia, Umbilicales



Braun-Stadler
VAA328514
14.5 cm / 5 1/2"
VAA328518
18 cm / 7 1/4"

Braun-Stadler
VAA329022
22 cm / 8 1/2"

Waldmann
VAA329518
18 cm / 7 1/4"
One toothed cutting edge

Busch
VAA330016 Straight
VAA330116 Curved
16 cm / 6 1/4"

Schuhmacher
VAA330515
15.5 cm / 6"

Modell USA
VAA331010 10.5 cm / 4 1/4"
VAA331012 12.5 cm / 5"

قیچی ها



CE

SQS Certificate
ISO 9001:2000
ISO 13485:2003

55



Scissors

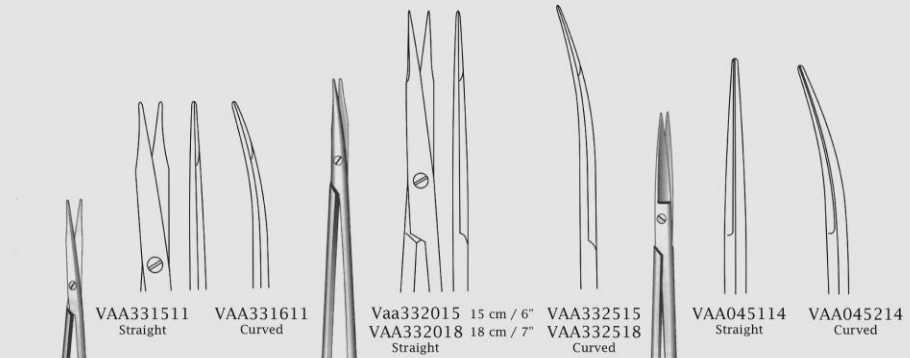
Fine Operating Scissors
Fiene chirurgische scheren
Tijeras finas para cirugía

قیچی ها



SQS Certificate
ISO 9001:2000
ISO 13485:2003

56

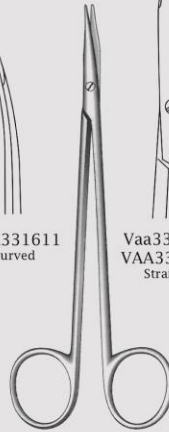


Reynolds
11 cm / 4 3/4"

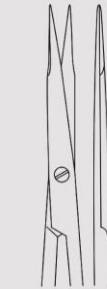
VAA331511
Straight



VAA331611
Curved



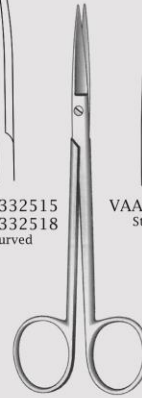
Reynolds



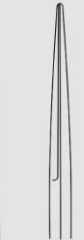
Vaa332015 15 cm / 6"
VAA332018 18 cm / 7"
Straight



VAA332515
VAA332518
Curved



Joseph
14 cm / 5 1/2"



VAA045114
Straight



VAA045214
Curved



Sanvenero
14 cm / 5 1/2"

VAA044114
Straight



VAA044214
Curved



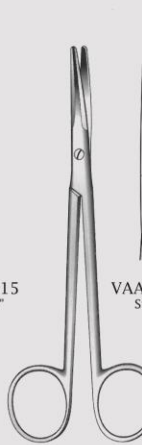
Kilner



VAA333513
13 cm / 5 1/4"



VAA333515
15 cm / 6"



14 cm / 5 1/2"



VAA334014
Straight



VAA334114
Curved



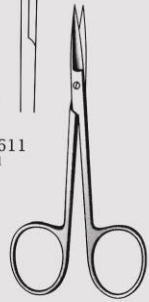
Scissors
 Fine Operating Scissors
 Feine chirurgische scheren
 Tijeras finas para cirugía



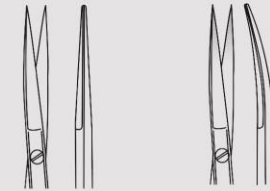
VAA334511
 Straight

VAA334611
 Curved

11 cm / 4 1/2"
 Dissecting post mortem scissors



Iris-Fine



VAA335009 9 cm / 3 1/2"
 VAA335010 10.5 cm / 4 1/4"
 Straight Flat

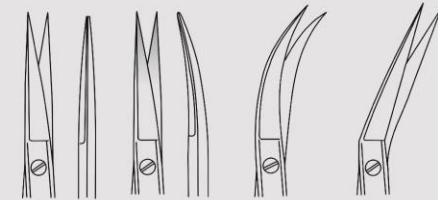
VAA335109 9 cm / 3 1/2"
 VAA335110 10.5 cm / 4 1/4"
 Straight Round

VAA335509
 VAA335510
 Curved Flat

VAA335609
 VAA335610
 Curved Round



Iris



VAA073111
 11.5 cm / 4 1/2"
 Flat

VAA073211
 11.5 cm / 4 1/2"
 Flat

VAA073411
 11.5 cm / 4 1/2"

VAA073611
 11.5 cm / 4 1/2"

VAA203011
 11.5 cm / 4 1/2"
 Round

VAA203511
 11.5 cm / 4 1/2"
 Round

VAA203611
 9 cm / 3 1/2"
 Round

VAA203711
 9 cm / 3 1/2"
 Round

VAA336011
 VAA336110

VAA336511
 VAA336610

11 cm / 4 1/2"
 10 cm / 3 3/4"

VAA336210
 With large rings

VAA336710
 With large rings

10 cm / 3 3/4"



Steven

VAA337011
 VAA337110

VAA337511 11 cm / 4 1/2"
 VAA337610 10 cm / 3 3/4"

VAA337210
 With large rings

VAA337710 10 cm / 3 3/4"
 With large rings

قیچی ها



CE

SQS Certificate
 ISO 9001:2000
 ISO 13485:2003

57



Scissors

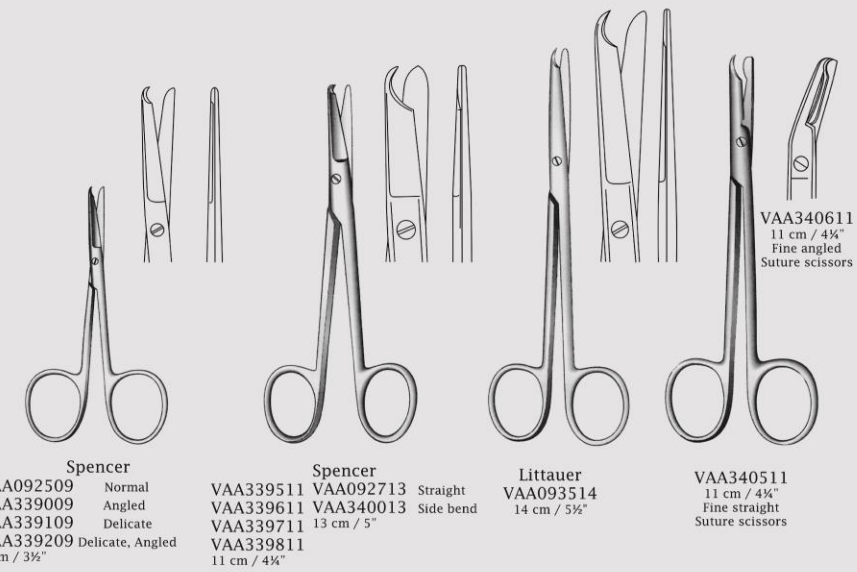
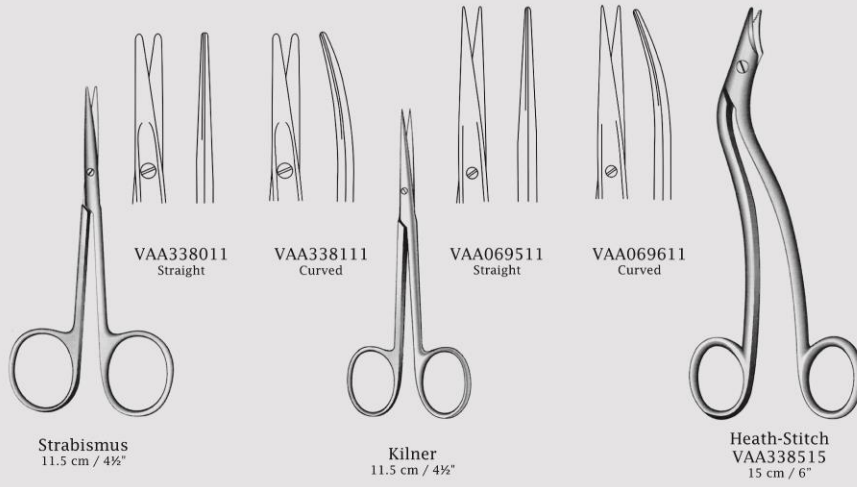
Fine Operating Scissors & Ligature Scissors
 Feine chirurgische Scheren und Ligaturscheren
 Tijeras finas para cirugía y Tijeras para ligaduras

قیچی ها



SQS Certificate
 ISO 9001:2000
 ISO 13485:2003

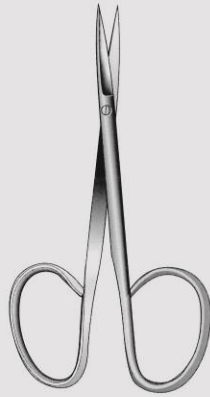
58



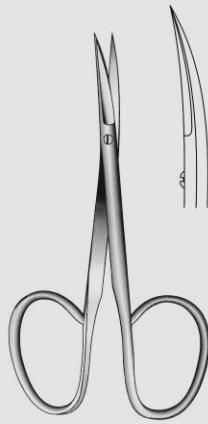


Scissors

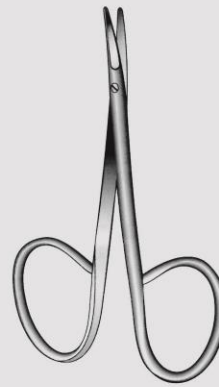
Fine Operating Scissors (Ribbon Type)
Fiene chirurgische scheren
Tijeras finas para cirugía



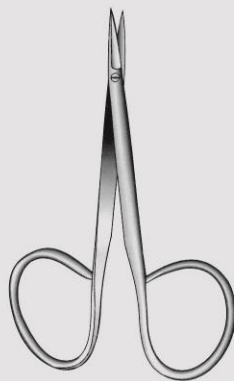
Iris
VAA341010
10 cm / 4"
Straight
Standard pattern, ribbon type



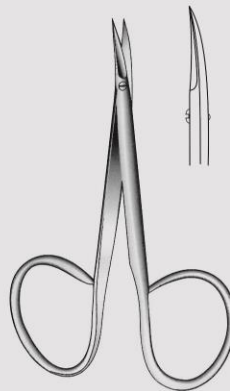
Iris
VAA341510
10 cm / 4"
Curved
Standard pattern, ribbon type



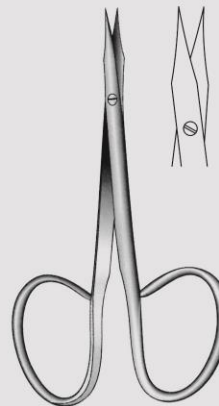
Utility
VAA342010
10 cm / 4"
Curved
Blunt blade 15 mm
long, ribbon type



Iris
VAA342510
10 cm / 4"
Straight with 14 mm blades
Miniature pattern, ribbon type



Iris
VAA343010
10 cm / 4"
Curved with 14 mm blades
Miniature pattern, ribbon type



Stevens-Grade
VAA343510 Sharp/Sharp, straight
VAA343610 Blunt/Blunt, straight
VAA343710 Sharp/Sharp, curved
VAA343810 Blunt/Blunt, curved
10 cm / 3 3/4"
Ribbon Tenotomy scissor

قیچی ها



CE

SQS Certificate
ISO 9001:2000
ISO 13485:2003

59



Scissors

Fine Operating Scissors & Ligature Scissors
Feine chirurgische scheren und Ligaturschere
Tijeras finas para cirugía y Tijeras para ligaduras

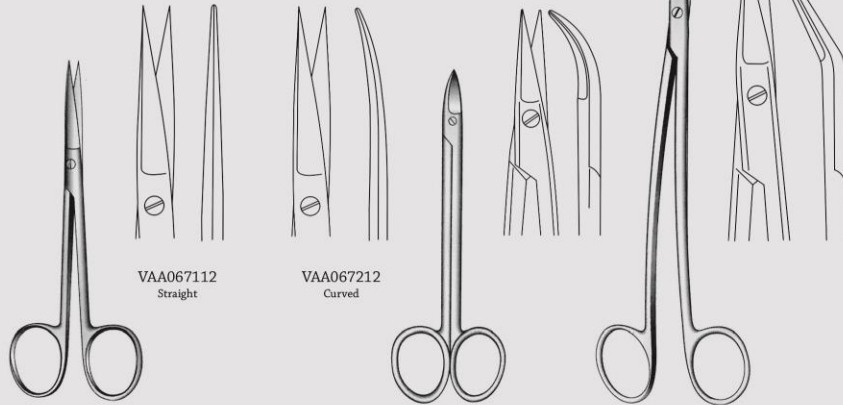
قیچی ها



CE

SQS Certificate
ISO 9001:2000
ISO 13485:2003

60



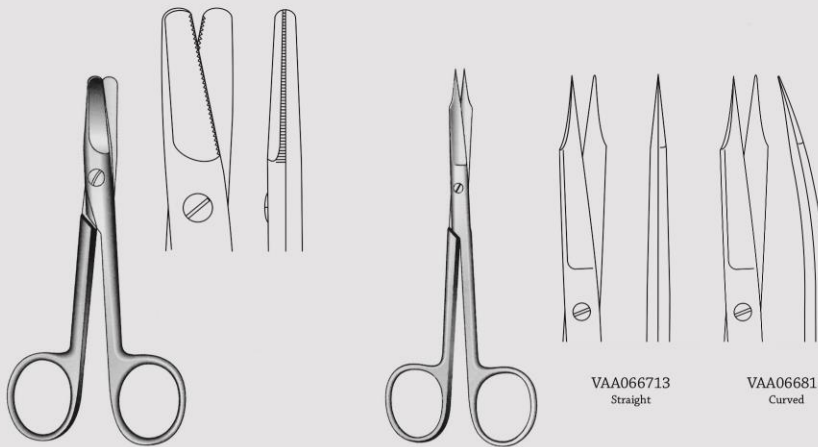
VAA067112
Straight

VAA067212
Curved

Wagner
12 cm / 4 3/4"

Quinby
VAA344012
12.5 cm / 5"

Neumann
VAA344512
12 cm / 4 3/4"



Harvey
VAA096312
12.5 cm / 5"
Serrated

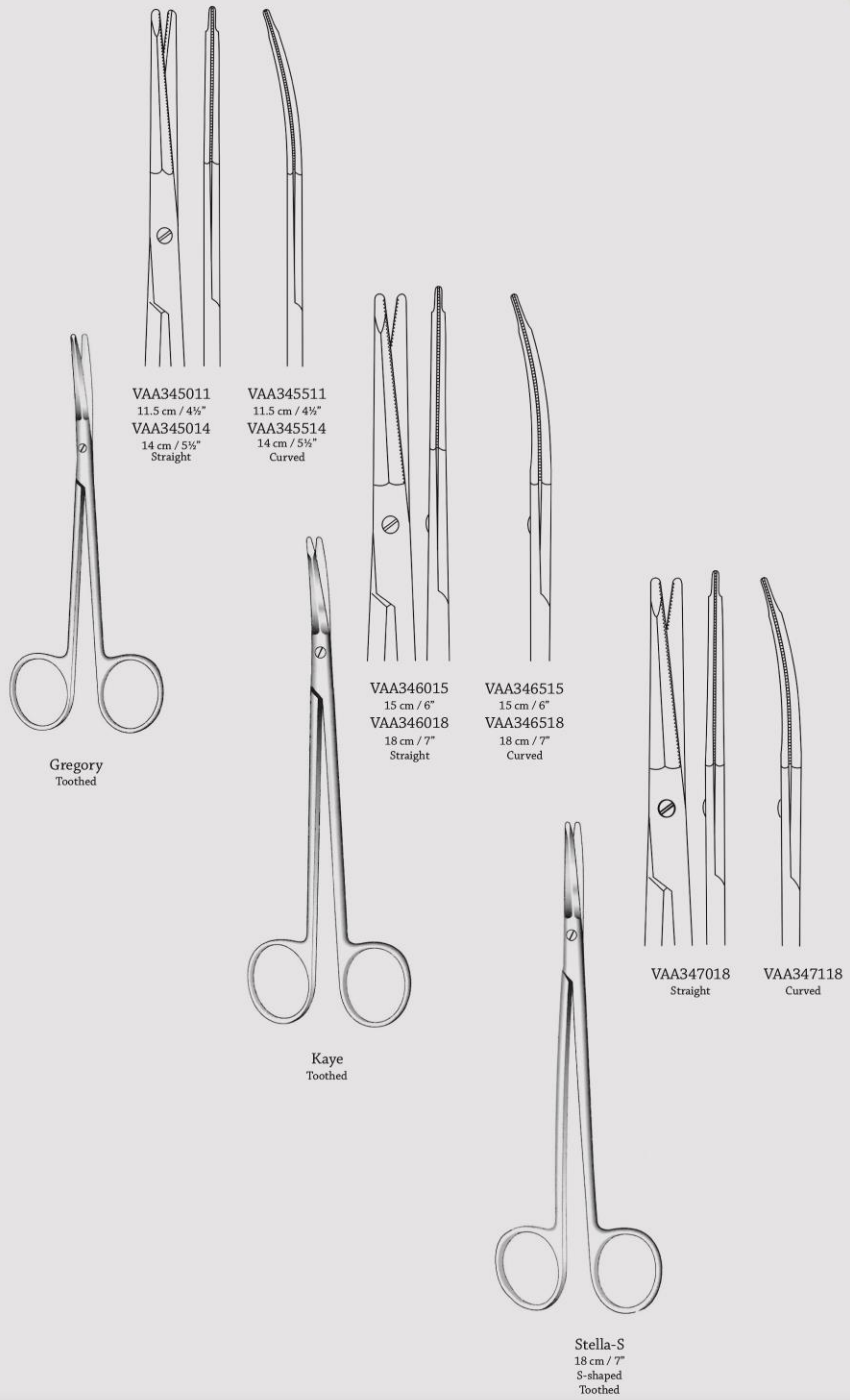
Goldman-Fox
13 cm / 5"

VAA066713
Straight

VAA066813
Curved



Scissors
Face-Lift Scissors
Face-Lift-Scheren
Tijeras para Face-lift



VAA345011
11.5 cm / 4 1/2"
VAA345014
14 cm / 5 1/2"
Straight

VAA345511
11.5 cm / 4 1/2"
VAA345514
14 cm / 5 1/2"
Curved

VAA346015
15 cm / 6"
VAA346018
18 cm / 7"
Straight

VAA346515
15 cm / 6"
VAA346518
18 cm / 7"
Curved

VAA347018
Straight

VAA347118
Curved

Gregory
Toothed

Kaye
Toothed

Stella-S
18 cm / 7"
S-shaped
Toothed

قیچی ها



CE

SQS Certificate
ISO 9001:2000
ISO 13485:2003

61



Scissors
 Face-Lift Scissors
 Face-Lift-Scheren
 Tijeras para Face-lift

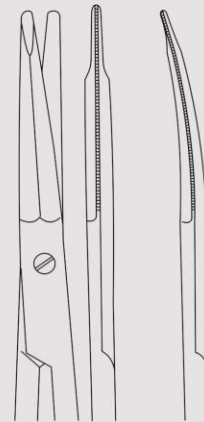
قیچی ها



CE

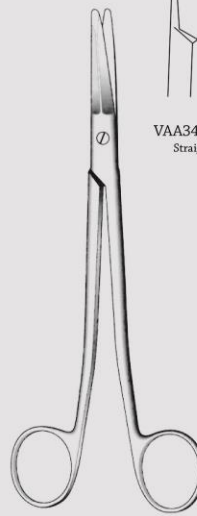
SQS Certificate
 ISO 9001:2000
 ISO 13485:2003

62

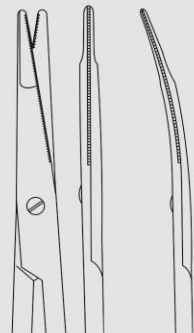


VAA348018
Straight

VAA348118
Curved

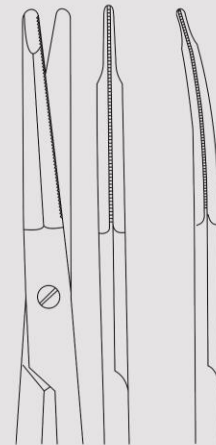


Freeman-Kaye
18 cm / 7"
Toothed



VAA347518
Straight

VAA347618
Curved



VAA348523
Straight

VAA348623
Curved



Gorney
18 cm / 7"
Toothed

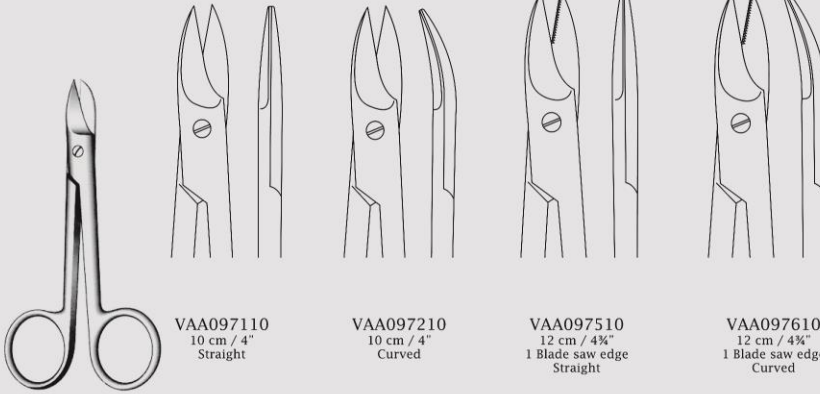


Freeman
23 cm / 9"
Toothed



Scissors

Operating Gum & Ligature Scissors
Chirurgische, Zahnfleisch Und Ligature scheren
Tijeras Para cirugía Y Encías, Ligaduras



Crown-Beebe

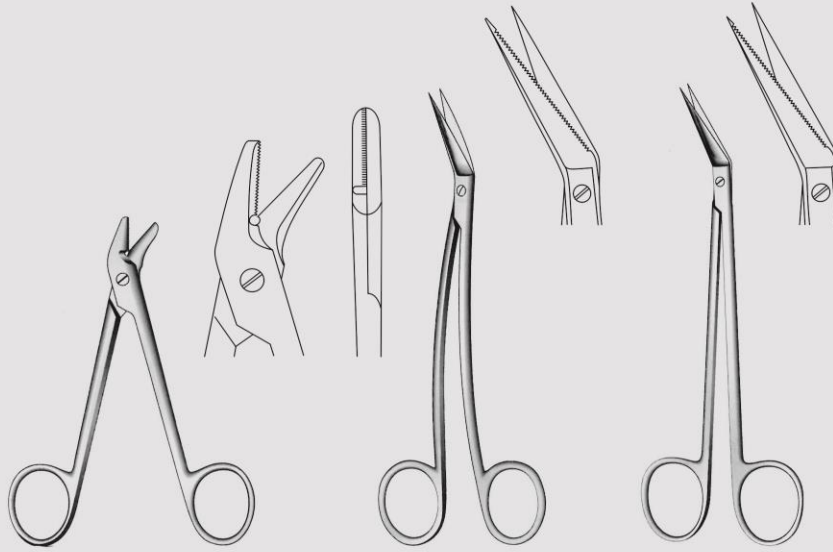
VAA097110
10 cm / 4"
Straight

VAA097210
10 cm / 4"
Curved

VAA097510
12 cm / 4 3/4"
1 Blade saw edge
Straight

VAA097610
12 cm / 4 3/4"
1 Blade saw edge
Curved

قیچی ها



Universal
VAA096612
12 cm / 4 3/4"
Serrated

Locklin
VAA070816
16 cm / 6 3/4"

VAA070616
16 cm / 6 3/4"



SQS Certificate
ISO 9001:2000
ISO 13485:2003

63



Scissors

Enterotomy, Nail Splitting Scissors
Darmscheren, Nagelspaltscheren
Tijeras para hender unas y enterotomos

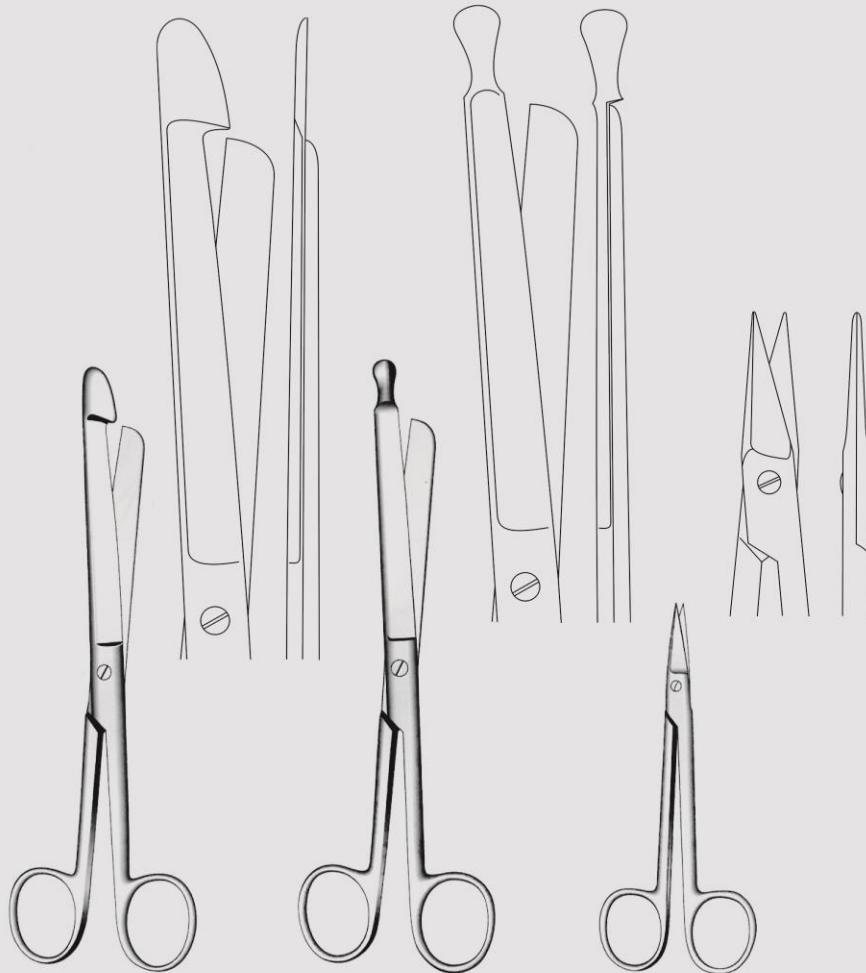
قیچی ها



CE

SQS Certificate
ISO 9001:2000
ISO 13485:2003

64



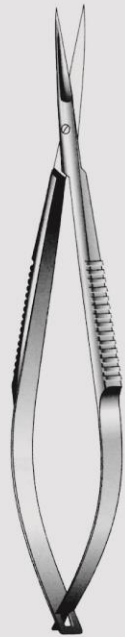
VAA349021
21 cm / 8 1/2"

VAA349521
21 cm / 8 1/2"
Enterotomy, postmortem and
nail splitting scissors

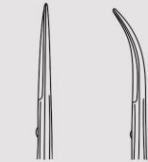
Systrunk
VAA350013
13 cm / 5"



Scissors
Micro Scissors
Mikro Scheren
Micro Tijeras



Westcott
11.5 cm / 4 1/2"



VAA350511 VAA350611



VAA351009
9 cm / 3 1/2"



VAA351511
11 cm / 4 1/2"



VAA352012
12 cm / 5"



VAA352509
9 cm / 3 1/2"

قیچی ها



CE

SQS Certificate
ISO 9001:2000
ISO 13485:2003

65



Scissors
Micro Scissors
Mikro Scheren
Micro Tijeras

قیچی ها



SQS Certificate
ISO 9001:2000
ISO 13485:2003

66



VAA087400
14 cm / 5 1/2"



VAA353018
Straight



VAA353118
Curved



VAA353218
Angled



VAA087401
15.5 cm / 6"



VAA087402
15.5 cm / 6"
1 Blade saw edge



VAA085814
14 cm / 5 1/2"



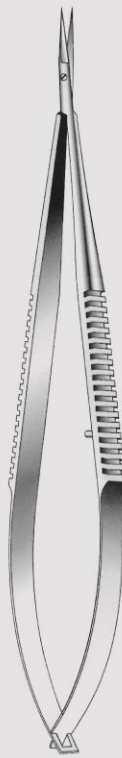
VAA085914
14 cm / 5 1/2"



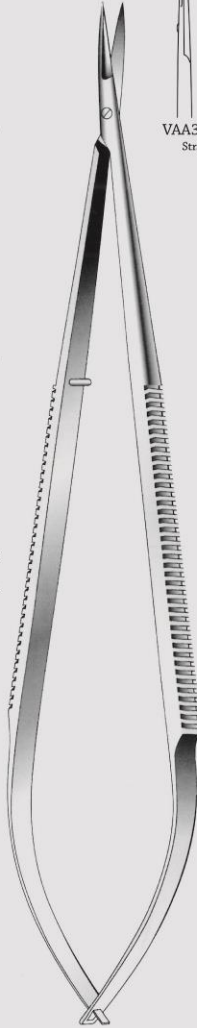
VAA085816
16 cm / 6 1/4"



VAA086016
16 cm / 6 1/4"



Reill



18.5 cm / 7 1/4"



Gomel



Hepp / Scheidel



Scissors
Micro Scissors
Mikro Scheren
Micro Tijeras

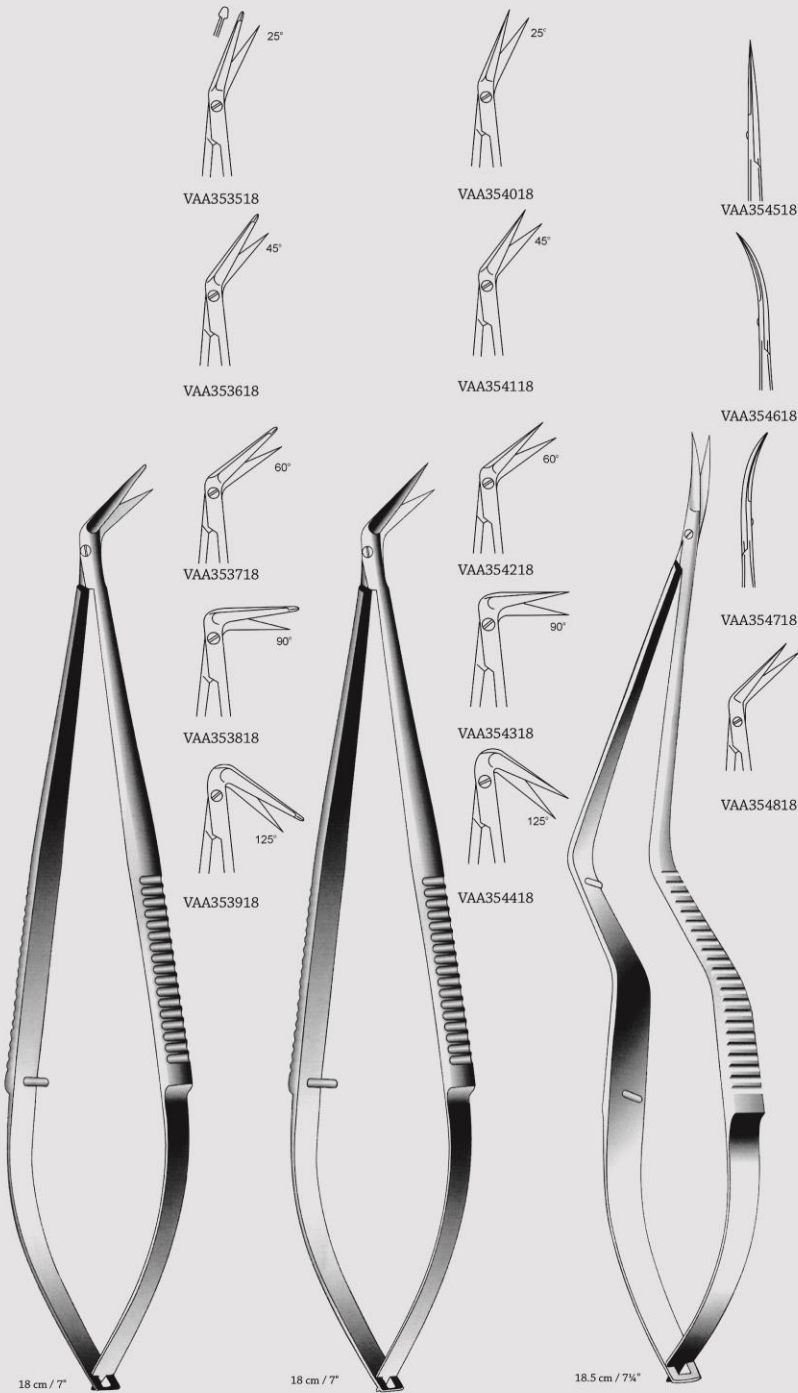
قیچی ها



CE

SQS Certificate
ISO 9001:2000
ISO 13485:2003

67





Scissors
 Micro Scissors
 Mikro Scheren
 Micro Tijeras

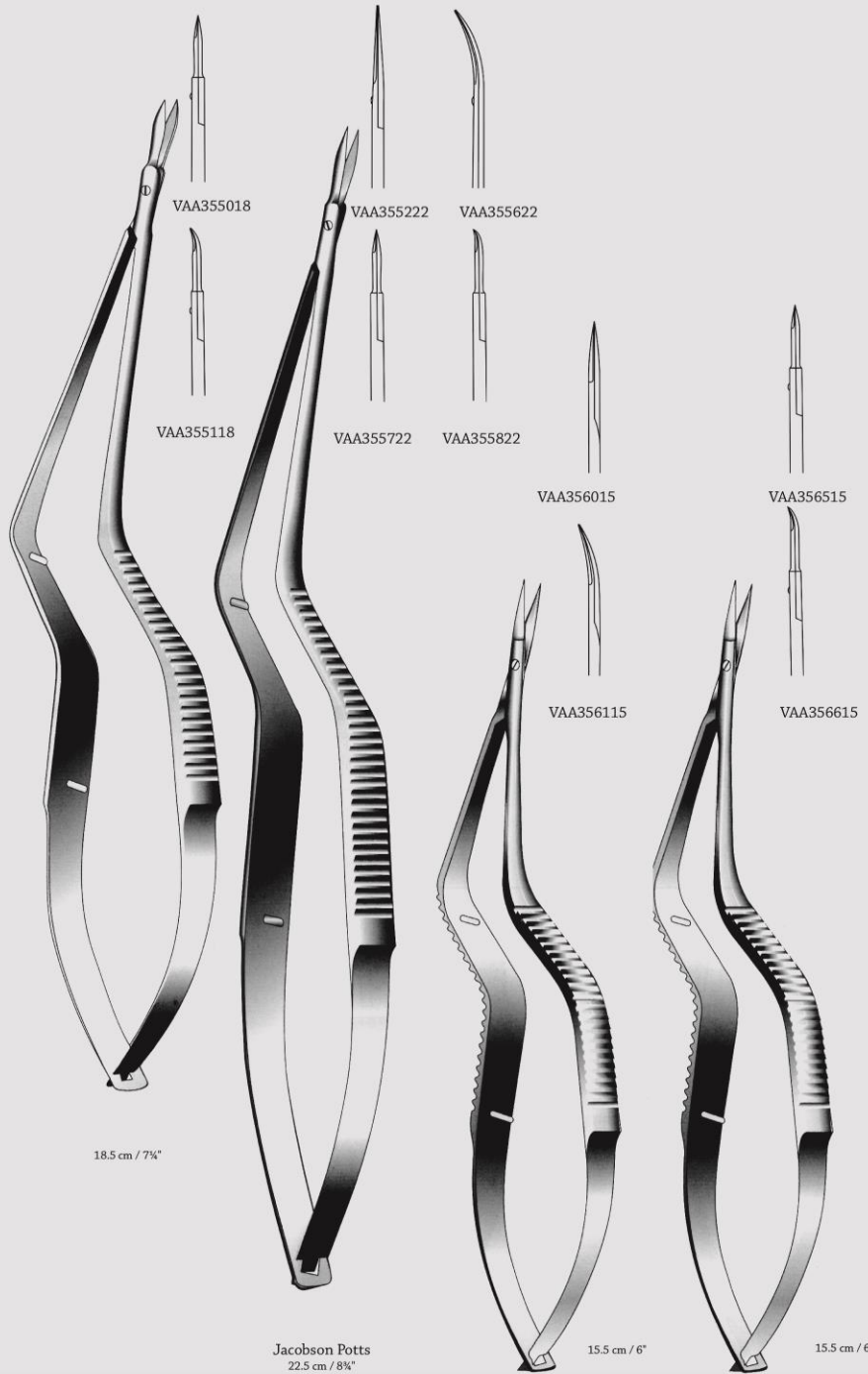
قیچی ها



CE

SQS Certificate
 ISO 9001:2000
 ISO 13485:2003

68



Instruments with Tungsten Carbide Inserts

Tc Gold



Scissors
Bandage Scissors
Verbandscheren
Tijeras Para Vendajes



VBA200114 Black
VBA200214 Red
VBA200314 Blue
VBA200414 Yellow
VBA200514 Orange
VBA200614 Bright pink
14.5 cm / 5 7/8"



VBA031018 Black
VBA201018 Red
VBA201118 Blue
VBA201218 Yellow
VBA201318 Orange
VBA201418 Bright pink
18 cm / 7"



Knowles
VBA026114 Straight
VBA202014 Angled
14 cm / 5 1/2"

VBA026609	Lister	9 cm / 3 1/2"	VAA357009T
VBA026611		11 cm / 4 1/4"	VAA357011T
VBA026614		14 cm / 5 1/2"	VAA357014T
VBA026616		16 cm / 6 1/4"	VAA357016T
VBA026618		18 cm / 7"	VAA357018T
VBA026620		20 cm / 8"	VAA357020T



Lister Bandage Scissors
For left hand
VAA357514 14 cm / 5 1/2"
VAA357518 18 cm / 7"



Esmarch
VBA030620 20 cm / 8"
VBA030622 22 cm / 8 3/4"



Bergmann
VBA029623
23 cm / 9"



Bruns
VBA039824 Plain
23.5 cm / 9 1/4"
VBA202524T Serrated
24 cm / 9 1/2"

قیچی ها



CE

SQS Certificate
ISO 9001:2000
ISO 13485:2003

69



Scissors

Scissors with Tungsten Carbide Inserts
 Scheren Mit Hartmetalleinsätzen
 Tijeras Con Filos De Carburo De Tungsteno

قیچی ها



CE

SQS Certificate
 ISO 9001:2000
 ISO 13485:2003



Instruments with Tungsten Carbide Inserts Tc Gold

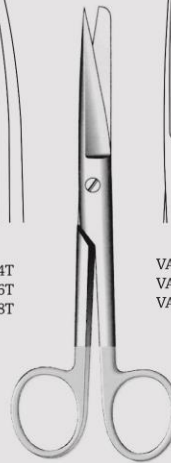


VAA358014T 14.5 cm / 5 7/8"
 VAA358016T 16 cm / 6 1/4"
 VAA358018T 18 cm / 7"
 Straight

Standard



VAA358514T
 VAA358516T
 VAA358518T
 Curved



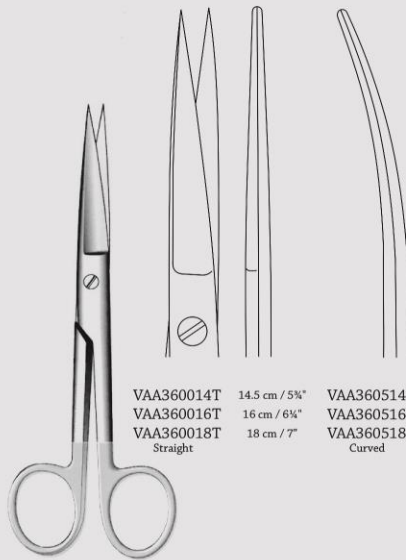
Standard



VAA359014T 14.5 cm / 5 7/8"
 VAA359016T 16 cm / 6 1/4"
 VAA359018T 18 cm / 7"
 Straight



VAA359514T
 VAA359516T
 VAA359518T
 Curved



VAA360014T 14.5 cm / 5 7/8"
 VAA360016T 16 cm / 6 1/4"
 VAA360018T 18 cm / 7"
 Straight

Standard



VAA360514T
 VAA360516T
 VAA360518T
 Curved



Mayo



VAA361014T 14.5 cm / 5 7/8"
 VAA361017T 17 cm / 6 3/4"
 VAA361023T 23 cm / 9"
 Straight




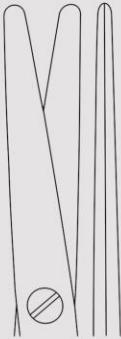

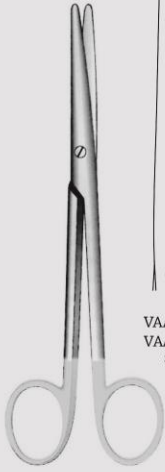
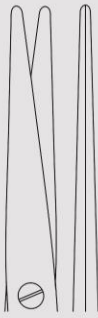

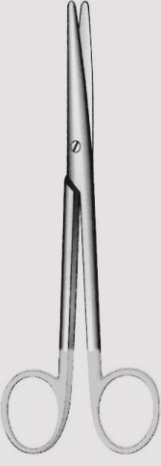



VAA361514T
 VAA361517T
 VAA361523T
 Curved

Instruments with Tungsten Carbide Inserts
Tc Gold



Scissors

Scissors with Tungsten Carbide Inserts
 Scheren Mit Hartmetalleinsätzen
 Tijeras Con Filos De Carburo De Tungsteno

 <p>Mayo-Style</p>	 <p>VAA362015T 15 cm / 6" VAA362017T 17 cm / 6 3/4" Straight</p>	 <p>VAA362515T VAA362517T Curved</p>	 <p>Lexer</p>	 <p>VAA363016T 16 cm / 6 1/2" VAA363021T 21 cm / 8 3/4" Straight</p>	 <p>VAA363516T VAA363521T Curved</p>
	 <p>Mayo-Lexer 16 cm / 6 3/4"</p>	 <p>VAA364016T Straight</p>		 <p>VAA364116T Curved</p>	 <p>Metzenbaum</p>

قیچی ها



CE

SQS Certificate
 ISO 9001:2000
 ISO 13485:2003

71



Scissors

Scissors with Tungsten Carbide Inserts
 Scheren Mit Hartmetalleinsätzen
 Tijeras Con Filos De Carburo De Tungsteno

قیچی ها



CE

SQS Certificate
 ISO 9001:2000
 ISO 13485:2003

72

Instruments with Tungsten Carbide Inserts

Tc Gold



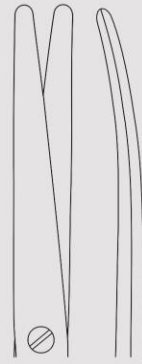
Metzenbaum



VAA365514T 14.5 cm / 5 3/4"
 VAA365518T 18 cm / 7"
 VAA365520T 20 cm / 8"
 VAA365523T 23 cm / 9"
 VAA365525T 25 cm / 10"
 VAA365528T 28 cm / 11"
 VAA365530T 30 cm / 12"
 Straight



Metzenbaum



VAA366014T 14.5 cm / 5 3/4"
 VAA366018T 18 cm / 7"
 VAA366020T 20 cm / 8"
 VAA366023T 23 cm / 9"
 VAA366025T 25 cm / 10"
 VAA366028T 28 cm / 11"
 VAA366030T 30 cm / 12"
 Curved



Metzenbaum-Fino
 Delicate



VAA105514T 14.5 cm / 5 3/4"
 VAA105518T 18 cm / 7"
 VAA105520T 20 cm / 8"
 VAA105523T 23 cm / 9"
 VAA105525T 25 cm / 10"
 VAA105528T 28 cm / 11"
 VAA105530T 30 cm / 12"
 Straight



VAA105614T 14.5 cm / 5 3/4"
 VAA105618T 18 cm / 7"
 VAA105620T 20 cm / 8"
 VAA105623T 23 cm / 9"
 VAA105625T 25 cm / 10"
 VAA105628T 28 cm / 11"
 VAA105630T 30 cm / 12"
 Curved



Metzenbaum-Fino



VAA105714T 14 cm / 5 1/2"
 VAA105716T 16 cm / 6 1/4"
 VAA105718T 18 cm / 7"
 VAA105720T 20 cm / 8"
 VAA105723T 23 cm / 9"
 Straight



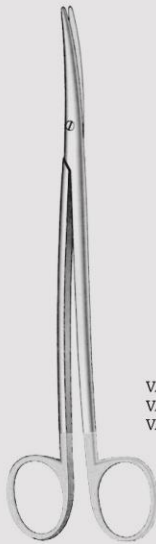
VAA105814T 14 cm / 5 1/2"
 VAA105816T 16 cm / 6 1/4"
 VAA105818T 18 cm / 7"
 VAA105820T 20 cm / 8"
 VAA105823T 23 cm / 9"
 Curved

Instruments with Tungsten Carbide Inserts
Tc Gold



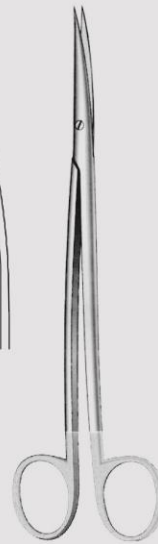
Scissors

Scissors with Tungsten Carbide Inserts
 Scheren Mit Hartmetalleinsätzen
 Tijeras Con Filos De Carburo De Tungsteno



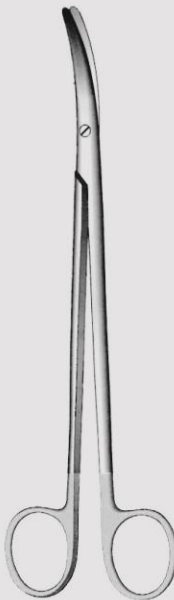
Metzenbaum-Fino
S-Shape

VAA106818T	18 cm / 7"	VAA106918T
VAA106820T	20 cm / 8"	VAA106920T
VAA106823T	23 cm / 9"	VAA106923T
	Straight	Curved



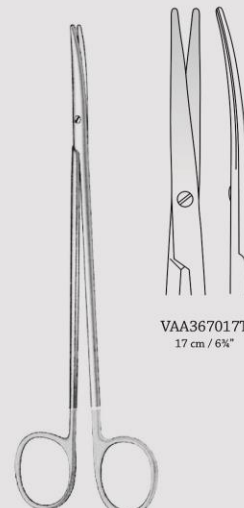
Metzenbaum-Fino
S-Shape

VAA107018T	18 cm / 7"	VAA107118T
VAA107020T	20 cm / 8"	VAA107120T
VAA107023T	23 cm / 9"	VAA107123T
	Straight	Curved



Metzenbaum-Thorek

VAA366520T	20 cm / 8"
VAA366523T	23 cm / 9"
VAA366528T	28 cm / 11"



Toennis-Adson

VAA367017T
17 cm / 6 3/4"

قیچی ها



CE

SQS Certificate
 ISO 9001:2000
 ISO 13485:2003

73



Scissors

Scissors with Tungsten Carbide inserts
Scheren Mit Hartmetalleinsätzen
Tijeras Con Filos De Carburo De Tungsteno

قیچی ها



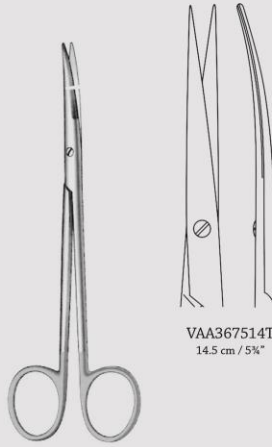
CE

SQS Certificate
ISO 9001:2000
ISO 13485:2003

74

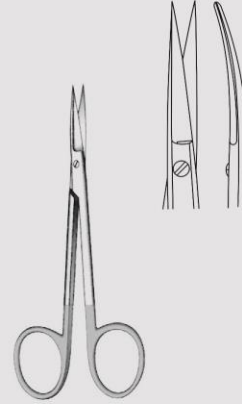
Instruments with Tungsten Carbide Inserts

Tc Gold

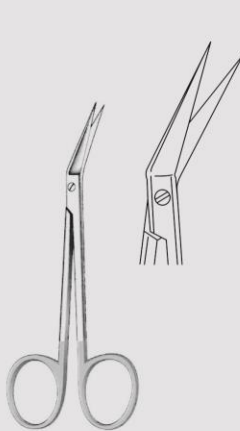


VAA367514T
14.5 cm / 5 7/8"

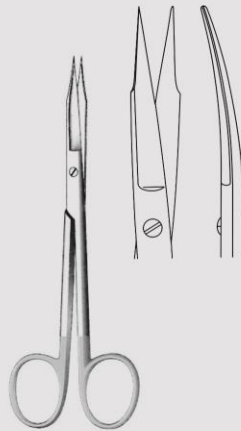
Metzenbaum-Lahey



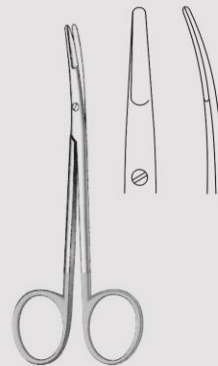
Iris
VAA108511T Straight
VAA108611T Curved
11.5 cm / 4 1/2"



VAA109011T Straight
VAA204513T Curved
13 cm / 5"



Goldman-Fox
VAA108113T Straight
VAA108213T Curved
13 cm / 5"



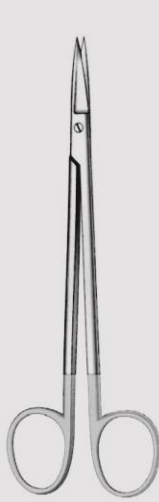
Ragnell (killner)
VAA109512T
12 cm / 4 3/4"

Instruments with Tungsten Carbide Inserts
Tc Gold

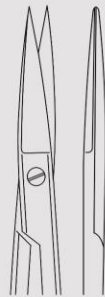


Scissors

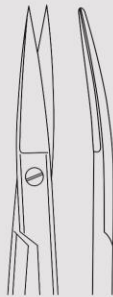
Scissors with Tungsten Carbide Inserts
 Scheren Mit Hartmetalleinsätzen
 Tijeras Con Filos De Carburo De Tungsteno



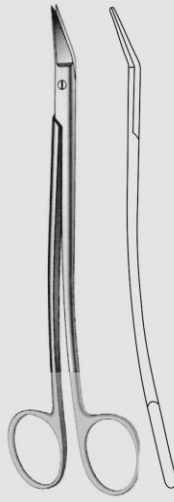
Kelly
 16 cm / 6 1/4"



VAA110016T
 Straight



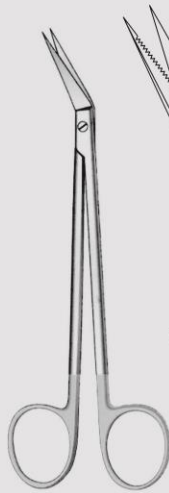
VAA110516T
 Curved



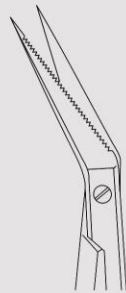
Dean



VAA111517T
 17 cm / 6 3/4"
 Saw edge
 S-shaped



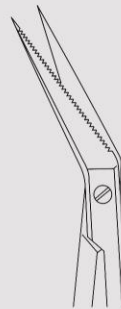
Locklin



VAA112016T
 16 cm / 6 1/4"
 Saw edge



Locklin



VAA112516T
 16 cm / 6 1/4"
 Saw edge

قیچی ها



CE

SQS Certificate
 ISO 9001:2000
 ISO 13485:2003

75



Scissors

Scissors with Tungsten Carbide inserts
Scheren Mit Hartmetalleinsätzen
Tijeras Con Filos De Carburo De Tungsteno

قیچی ها



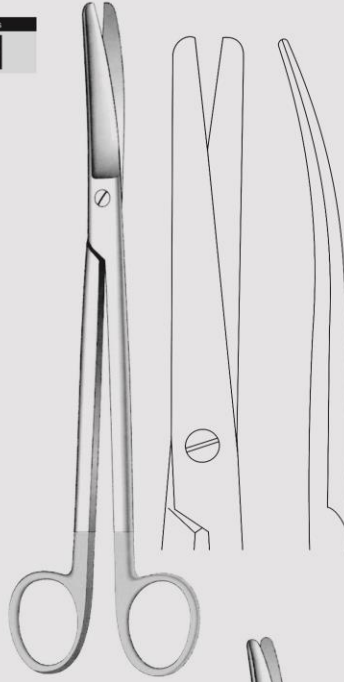
CE

SQS Certificate
ISO 9001:2000
ISO 13485:2003

76

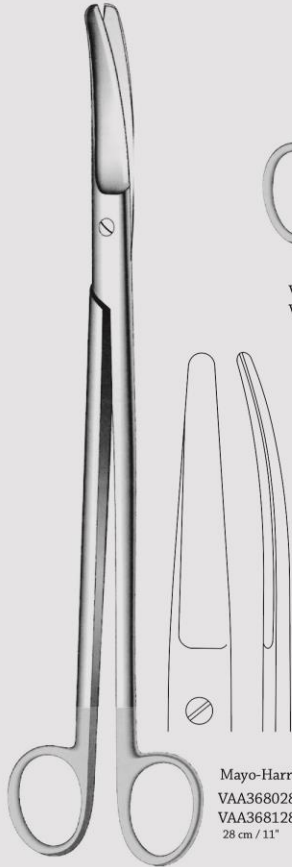
Instruments with Tungsten Carbide Inserts

Tc Gold



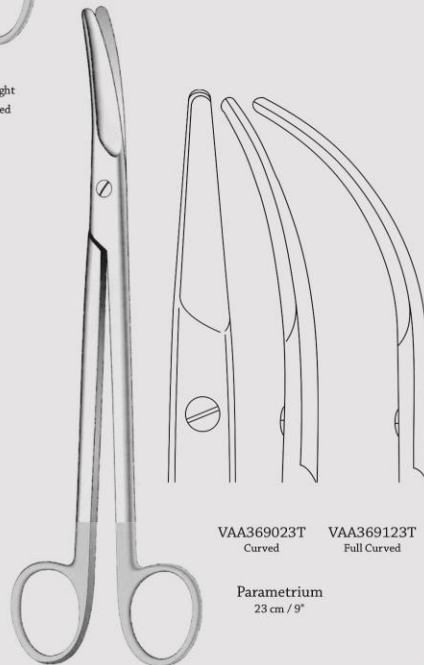
Sims

VAA368520T Straight
VAA368620T Curved
20 cm / 8"



Mayo-Harrington

VAA368028T Straight
VAA368128T Curved
28 cm / 11"



VAA369023T
Curved

VAA369123T
Full Curved

Parametrium
23 cm / 9"

Instruments with Tungsten Carbide Inserts
Tc Gold



Scissors

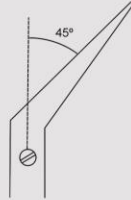
Scissors with Tungsten Carbide Inserts
 Scheren Mit Hartmetalleisätzen
 Tijeras Con Filos Carburo De Tungsteno



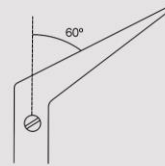
De Bakey (Potts-Smith)



VAA370023T
 23 cm / 9"
 25°



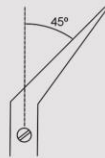
VAA370123T
 23 cm / 9"
 45°



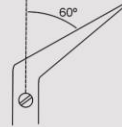
VAA370223T
 23 cm / 9"
 60°



VAA369519T
 19 cm / 7 1/2"
 25°



VAA369619T
 19 cm / 7 1/2"
 45°



VAA369719T
 19 cm / 7 1/2"
 60°



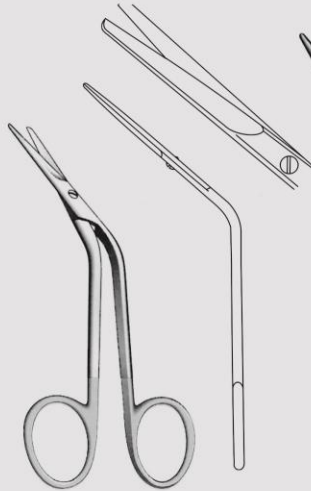
VAA371518T
 Straight



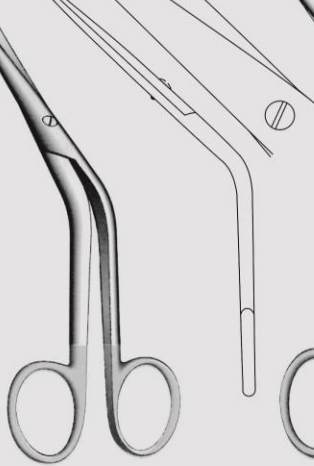
VAA371618T
 Curved left
 Serrated



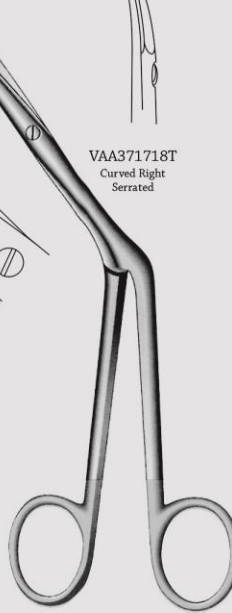
VAA371718T
 Curved Right
 Serrated



Fomon
 VAA370515T
 15 cm / 6"



Cottle
 VAA371016T
 16 cm / 6 1/4"



Knight Nasal Scissors
 18 cm / 7"

قیچی ها



CE

SQS Certificate
 ISO 9001:2000
 ISO 13485:2003

77



Scissors
Ligature Scissors
Ligaturscheren
Tijeras Para Ligaduras

قیچی ها

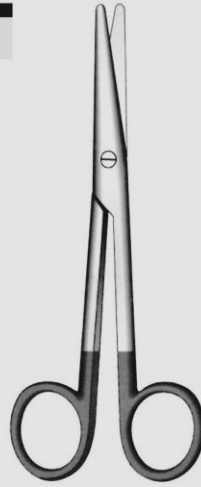


CE

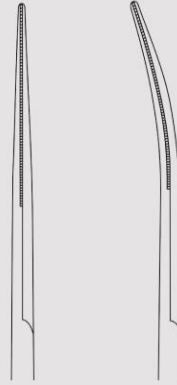
SQS Certificate
ISO 9001:2000
ISO 13485:2003

78

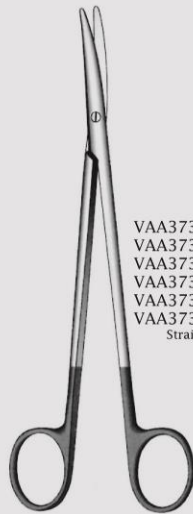
Instruments with Tungsten Carbide Inserts
Super Cut



Super Cut
One blade serrated
One blade sharp

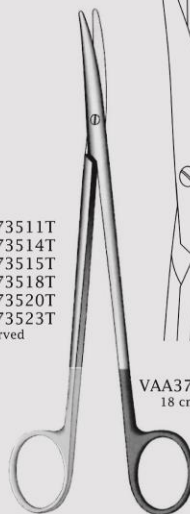


VAA372015T 15 cm / 6"	VAA372515T
VAA372016T 16 cm / 6 1/4"	VAA372516T
VAA372017T 17 cm / 6 3/4"	VAA372517T
VAA372019T 19 cm / 7 1/2"	VAA372519T
VAA372021T 21 cm / 8 1/2"	VAA372521T
Straight	Curved



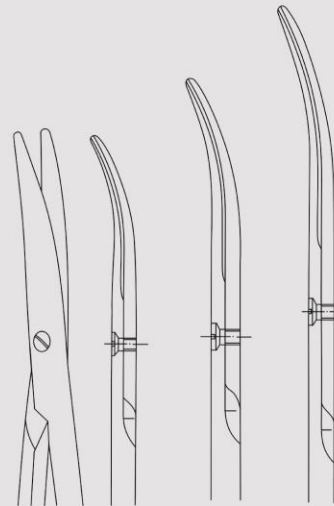
Super Cut
One blade serrated
One blade like knife

VAA373011T 11.5 cm / 4 1/2"	VAA373511T
VAA373014T 14.5 cm / 5 3/4"	VAA373514T
VAA373015T 15 cm / 6"	VAA373515T
VAA373018T 18 cm / 7"	VAA373518T
VAA373020T 20 cm / 8"	VAA373520T
VAA373023T 23 cm / 9"	VAA373523T
Straight	Curved



Open Shank

VAA374018T 18 cm / 7"	VAA374123T 23 cm / 9"	VAA374226T 26 cm / 10 1/4"
--------------------------	--------------------------	-------------------------------

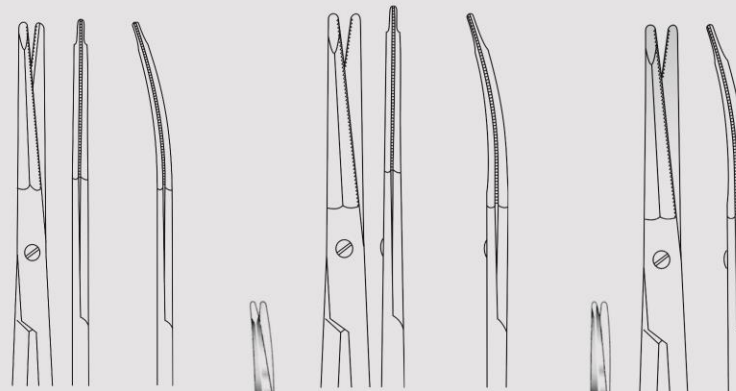




Instruments with Tungsten Carbide Inserts

Tc Gold

Scissors
Face-Lift Scissors
Face-Lift-Scheren
Tijeras para Face-lift



Gregory
Toothed

VAA374511T
11.5 cm / 4½"
VAA374514T
14 cm / 5½"
Straight

VAA374611T
11.5 cm / 4½"
VAA374614T
14 cm / 5½"
Curved



Kaye
Toothed

VAA375015T
15 cm / 6"
VAA375018T
18 cm / 7"
Straight

VAA375115T
15 cm / 6"
VAA375118T
18 cm / 7"
Curved



Stella-S
Toothed

VAA375518T
18 cm / 7"
S-shaped
Curved

قیچی ها



CE

SQS Certificate
ISO 9001:2000
ISO 13485:2003

79



Scissors
Face-Lift Scissors
Face-Lift-Scheren
Tijeras para Face-lift

قیچی ها



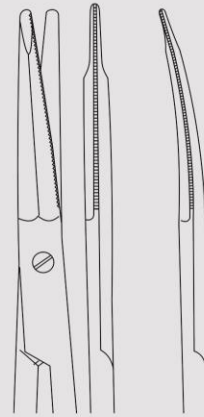
CE

SQS Certificate
ISO 9001:2000
ISO 13485:2003

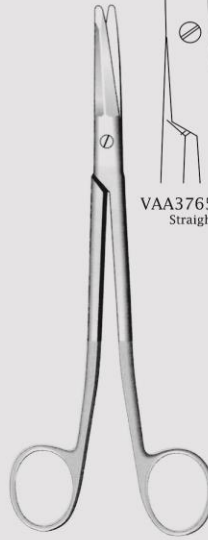
80

Instruments with Tungsten Carbide Inserts

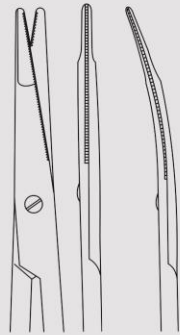
Tc Gold



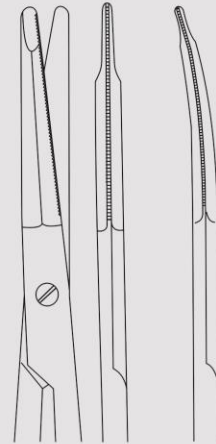
VAA376518T Straight
VAA376618T Curved



Freeman-Kaye
18 cm / 7"
Toothed



VAA376018T Straight
VAA376118T Curved



VAA377023T Straight
VAA377123T Curved



Gorney
18 cm / 7"
Toothed



Freeman
23 cm / 9"
Toothed

DIAMOND SURGICAL
WWW.DIAMONDMED.IR INSTRUMENTS



VAB

Dressing and
Tissue Forceps



CE

SQS Certificate
ISO 9001:2000
ISO 13485:2003

81



Dressing & Tissue Forceps

Dressing and Tissue Forceps
Anatomische chirurgische Pinzetten
Pinzas de diseccion Con Chentes

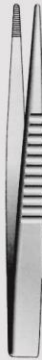
پنست ها



CE

SQS Certificate
ISO 9001:2000
ISO 13485:2003

82



English
T.O.E
VAB300112 12.5 cm / 5"
VAB300115 15 cm / 6"
VAB300118 18 cm / 7"
VAB300120 20 cm / 8"



English
VAB300512 12.5 cm / 5"
VAB300515 15 cm / 6"
VAB300518 18 cm / 7"
B/end



Treves
VAB301012 12.5 cm / 5" VAB301512
VAB301015 15 cm / 6" VAB301515
VAB301018 18 cm / 7" VAB301518
1:2 teeth 2:3 teeth



Standard
VAB020110 10 cm / 4"
VAB020111 11.5 cm / 4½"
VAB020113 13 cm / 5"
VAB020114 14.5 cm / 5½"
VAB020116 16 cm / 6¼"
VAB020118 18 cm / 7"
VAB020120 20 cm / 8"
VAB020123 23 cm / 9"
VAB020125 25 cm / 10"
VAB020130 30 cm / 12"



Standard Narrow
VAB022110
VAB022111
VAB022113
VAB022114
VAB022116
VAB022118
VAB022120
VAB022123
VAB022125
VAB022130



Tissue
VAB040210 10 cm / 4"
VAB040211 11.5 cm / 4½"
VAB040213 13 cm / 5"
VAB040214 14.5 cm / 5½"
VAB040216 16 cm / 6¼"
VAB040218 18 cm / 7"
VAB040220 20 cm / 8"
VAB040223 23 cm / 9"
VAB040225 25 cm / 10"
VAB040230 30 cm / 12"
1:2 Teeth



Tissue
VAB302010
VAB302011
VAB302013
VAB302014
VAB302016
VAB302018
VAB302020
VAB302023
VAB302025
VAB302030
2:3 Teeth



Dressing & Tissue Forceps

Dressing and Tissue Forceps
Anatomische chirurgische Pinzetten
Pinzas de diseccion Con Chentes



Tissue
VAB302513 13 cm / 5"
VAB302514 14.5 cm / 5½"
VAB302516 16 cm / 6¼"
3-4 Teeth



Tissue
VAB303013 13 cm / 5"
VAB303014 14.5 cm / 5½"
VAB303016 16 cm / 6¼"
4-5 Teeth



USA Standard Model
VAB303510 10 cm / 4"
VAB303513 13 cm / 5"
VAB303514 14.5 cm / 5½"
VAB303515 15.5 cm / 6"
VAB303518 18 cm / 7"
VAB303521 21 cm / 8¼"
VAB303525 25 cm / 10"
VAB303531 31 cm / 12¼"

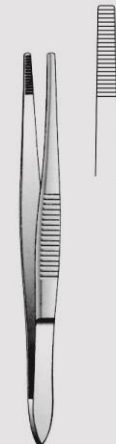


USA Standard Narrow
VAB304012 12 cm / 4¾"
VAB304013 13 cm / 5"
VAB304014 14.5 cm / 5½"
VAB304015 15 cm / 6"

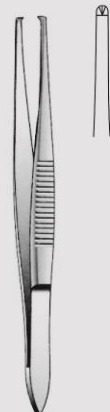
پنست ها



USA Model
VAB304512 12 cm / 4¾"
VAB304513 13 cm / 5"
VAB304514 14.5 cm / 5½"
VAB304515 15.5 cm / 6"
VAB304518 18 cm / 7"
VAB304521 21 cm / 8¼"
VAB304525 25 cm / 10"
VAB304531 31 cm / 12¼"
1-2 Teeth



Stille
VAB305015
15 cm / 6"



Stille
VAB305515
15 cm / 6"
1-2 Teeth



Stille
VAB306015
15 cm / 6"
2-3 Teeth



SQS Certificate
ISO 9001:2000
ISO 13485:2003



Dressing & Tissue Forceps

Dressing & Tissue Forceps
Anatomische chirurgische Pinzetten
Pinzas de diseccion Con Chentes

پنست ها



CE

SQS Certificate
ISO 9001:2000
ISO 13485:2003

84



Waugh
VAB308515
VAB308518
VAB308520

15 cm / 6"
18 cm / 7"
20 cm / 8"

Cross serration fine



VAB309512
12.5 cm / 5"

VAB309515
15 cm / 6"

Semken
VAB309015
VAB309018
VAB309020
1:2 teeth



Adson
1:2 Teeth



VAB046912
12 cm / 4 1/4"



VAB046915
15 cm / 6"



McIndoe
VAB027115
VAB200115
15 cm / 6"
1:2 Teeth



VAB026915
15 cm / 6"



VAB026912
12 cm / 4 1/4"



VAB306513 13 cm / 5"
VAB306514 14.5 cm / 5 1/2"
VAB306516 16 cm / 6 1/4"
Cross Serrated



Adson



Gillies
VAB047115
15 cm / 6"
1:2 Teeth



Lane

VAB307512 12.5 cm / 5"
VAB307515 15 cm / 6"
VAB307518 18 cm / 7"
VAB307520 20 cm / 8"
1:2 Teeth
VAB308012 12.5 cm / 5"
VAB308015 15 cm / 6"
VAB308018 18 cm / 7"
VAB308020 20 cm / 8"
2:3 Teeth



VAB310012
12.5 cm / 5"



VAB310015
15 cm / 6"

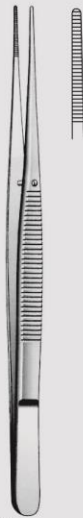


Semken
1:2 Teeth



Dressing & Tissue Forceps

Dressing and Tissue Forceps
Anatomische chirurgische Pinzetten
Pinzas de diseccion Con Chentes



Potts-smith
VAB310518 18 cm / 7"
VAB310521 21 cm / 8 1/4"
VAB310525 25 cm / 10"



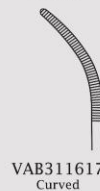
Potts-smith
VAB311018 18 cm / 7"
VAB311021 21 cm / 8 1/4"
VAB311025 25 cm / 10"
1:2 Teeth



Cushing
17.5 cm / 7"



VAB311517
Straight



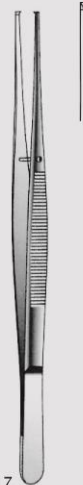
VAB311617
Curved



Cushing
VAB312017 Straight
VAB312117 Curved
17 cm / 6 3/4"
1:2 Teeth



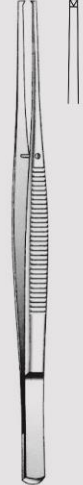
Taylor
VAB312517
17 cm / 6 3/4"



Taylor
VAB313017
17 cm / 6 3/4"
1:2 Teeth



Taylor
VAB313517
17 cm / 6 3/4"



Taylor
VAB314017
17 cm / 6 3/4"
1:2 Teeth

پنست ها



CE

SQS Certificate
ISO 9001:2000
ISO 13485:2003

85



Dressing & Tissue Forceps

Dressing Tissue & Grasping Forceps
Anatomische chirurgische Pinzetten
Pinzas De Diseccion Con Chentes Para Coger

پنست ها



CE

SQS Certificate
ISO 9001:2000
ISO 13485:2003

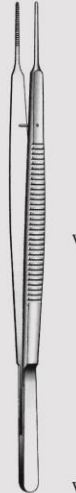
86



Taylor
VAB035718
18.5 cm / 7 1/4"



Taylor
VAB314517
17.5 cm / 7"
1:2 Teeth



Gerald
Serrated
18 cm / 7"



VAB042418
Straight

VAB044418
Curved



Gerald
17 cm / 6 3/4"
1:2 Teeth



VAB048717
Straight

VAB048817
Curved



T-Forceps
VAB315018
18 cm / 7"
Tip 17 mm



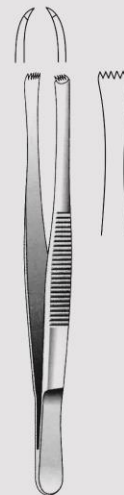
Brophy
VAB315520 Straight
VAB315620 Curved
20 cm / 8"



Brophy
VAB316020
20 cm / 8"
1:2 Teeth



Stone
VAB316515
15 cm / 6"
4:5 Teeth



Lerche
VAB317015
15 cm / 6"
5:6 Teeth



Duehrssen
VAB317520
20 cm / 8"



Wangensteen
VAB318023
23 cm / 9"



Nelson
VAB318523
23 cm / 9"



Single-Tuttle
VAB319023
23 cm / 9"



Russ-Modell
VAB319515 15 cm / 6"
VAB319520 20 cm / 8"
VAB319525 25 cm / 10"



Mayo-Russ
VAB320023
23 cm / 9"



Dressing & Tissue Forceps

Dressing Tissue and Grasping Forceps
Anatomische chirurgische pinzetten
Pinzas de diseccion con dientes para coger

پنست ها



SQS Certificate
ISO 9001:2000
ISO 13485:2003





Dressing & Tissue Forceps

Dressing Tissue & Grasping Forceps
Anatomische chirurgische Pinzetten
Pinzas De Deseccion Con Chentes Para Coger

پنست ها



SQS Certificate
ISO 9001:2000
ISO 13485:2003

88



VAB320514
14.5 cm / 5 7/8"



VAB320516
16 cm / 6 3/4"



VAB320520
20 cm / 8"

Durante



Bonney
18 cm / 7"



VAB321018
1:2 Teeth



VAB321118
2:3 Teeth



Ferris-Smith
18 cm / 7"



VAB321518
1:2 Teeth



VAB321618
2:3 Teeth



Duval
VAB322014
14.5 cm / 5 7/8"



Collin-Duval
VAB322520 14 mm
VAB322620 25 mm
20 cm / 8"





Dressing & Tissue Forceps

Micro Forceps, Splinter Forceps
Micro-pinzetten, Splitter-pinzetten
Micro-pinzas, Pinzas para espinas



Iris
11.5 cm / 4 1/2"



VAB323511



VAB323611



VAB323711



VAB324011
1:2 Teeth



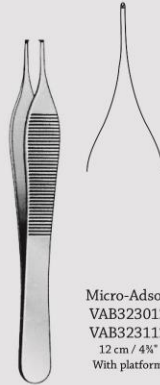
VAB324111
1:2 Teeth



VAB324211
1:2 Teeth



Micro-Adson
VAB050512
12 cm / 4 3/4"



Micro-Adson
VAB323012
VAB323112
12 cm / 4 3/4"
With platform



Adson-Brown
VAB050112
12 cm / 4 3/4"
7:7 Teeth



Feilchenfeld



VAB324507
7.5 cm / 3"



VAB324509
9 cm / 3 1/2"



VAB324511
11.5 cm / 4 1/2"



VAB325012
12.5 cm / 5"

پنست ها



CE

SQS Certificate
ISO 9001:2000
ISO 13485:2003

89



Dressing &
Tissue Forceps
Splinter Forceps
Splitter-pinzetten
Pinzas para espinas

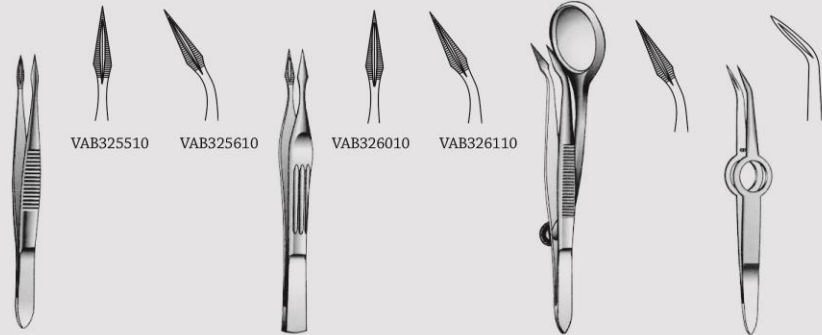
بخش ناخن



CE

SQS Certificate
ISO 9001:2000
ISO 13485:2003

90

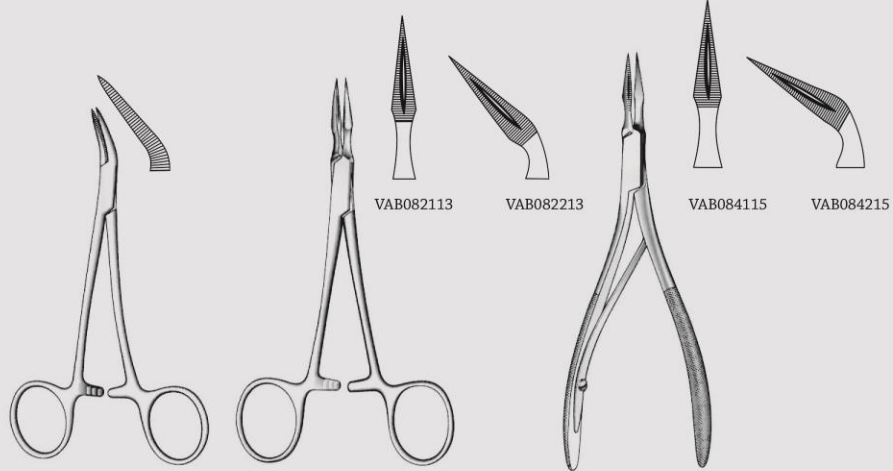


Hunter
10.5 cm / 4"

Walter-Carmalt
10.5 cm / 4"

VAB326512
12 cm / 4"

Shaaf
VAB327009
9 cm / 3"



Peet
VAB082611
11.5 cm / 4"

Stieglitz
13.5 cm / 5"

Ralk
15 cm / 6"



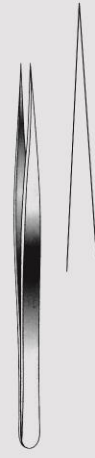
Dressing &
Tissue Forceps
Jeweler Type Forceps
Uhrmacher-pinzetten
Pinzas de relojero



VAB327511
11.5 cm / 4½"
0.2 mm
Fig. 7



VAB328011
11.5 cm / 4½"
0.4 mm
1:2 Teeth

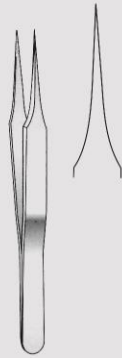


VAB328513
13.5 cm / 5¼"
0.3 mm
Fig. 3



VAB329011
11 cm / 4¼"
0.4 mm
1:2 Teeth

پنست ها



VAB329511
11 cm / 4¼"
0.2 mm
Fig. 4



VAB330011
11 cm / 4¼"
0.15 mm
Fig. 5



VAB330511
11 cm / 4¼"
0.3 mm



CE

SQS Certificate
ISO 9001:2000
ISO 13485:2003

91



Dressing &
Tissue Forceps
Cilia Forceps
Cilienpinzetten
Pinzas depilatorias

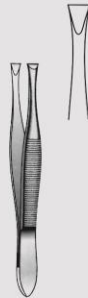
پنست ها



CE

SQS Certificate
ISO 9001:2000
ISO 13485:2003

92



Littauer
VAB331008
8.5 cm / 3 3/8"
Smooth jaw



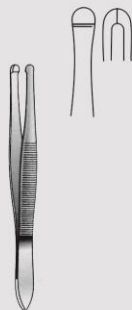
VAB331509
9 cm / 3 1/2"



Douglas
VAB332009
9 cm / 3 1/2"



Douglas
VAB332509
9 cm / 3 1/2"



Beer
VAB333009
9 cm / 3 1/2"
Smooth jaw



Gradle
VAB333509
9.5 cm / 3 3/4"



Henry
VAB334012
12 cm / 4 3/4"



Barraquer
VAB334510
10.5 cm / 4 1/4"
Smooth jaw



Dressing &
Tissue Forceps
Dissecting Forceps
Pinzetten
Pinzas De Diseccion



0.5
Normal Profile
Normal Profil
Profil Normal

Ferris Smith
VAB335018T
18 cm / 7"



Gerald
17 cm / 6 3/4"



0.2
VAB033317T
Micro Profile
Mikro Profil
Profil Micro



0.4
VAB033517T
Mini Profile
Mini Profil
Profil Mini



Mc Indoe
VAB033915T
15 cm / 6"



0.4
Mini Profile
Mini Profil
Profil Mini

پنست ها



Potts-Smith



0.5
VAB335515T
15 cm / 6"



0.5
VAB335518T
18 cm / 7"



0.5
VAB335520T
20 cm / 8"



0.5
VAB335523T
23 cm / 9"

Normal Profile
Normal Profil
Profil Normal



0.5
VAB335525T
25 cm / 10"



Bonney
17 cm / 6 3/4"



0.5
VAB336017T
Normal Profile
Normal Profil
Profil Normal



0.5
VAB336117T
Normal Profile
Normal Profil
Profil Normal



0.4
Mini Profile
Mini Profil
Profil Mini



Gillies
VAB033715T
15 cm / 6"



SQS Certificate
ISO 9001:2000
ISO 13485:2003

93



Dressing &
Tissue Forceps
Dissecting Forceps
Pinzetten
Pinzas De Disseccion

پنست ها



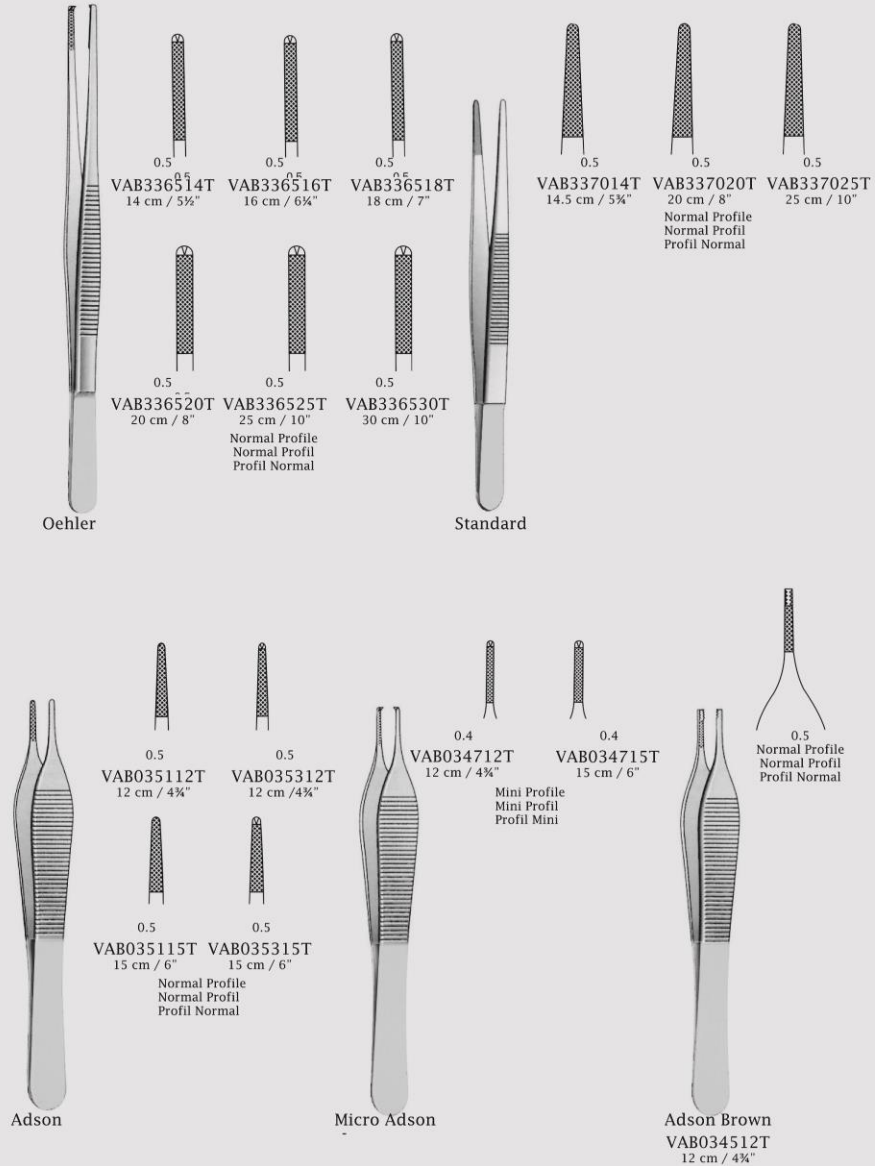
CE

SQS Certificate
ISO 9001:2000
ISO 13485:2003

94

Instruments with Tungsten Carbide Inserts

Tc Gold





Dressing &
Tissue Forceps
Dissecting Forceps
Pinzetten
Pinzas De Disecion



0.5
VAB035517T 17.5 cm / 6 7/8"
VAB035520T 20 cm / 8"
VAB035525T 25 cm / 10"
Normal Profile
Normal Profil
Profil Normal

Cushing



0.5
Normal Profile
Normal Profil
Profil Normal

Cushing
VAB035618T
18 cm / 7"



0.5
Normal Profile
Normal Profil
Profil Normal

Cushing-Taylor
VAB035718T
18 cm / 7"



0.5
VAB034116T 16 cm / 6 1/4"
VAB034118T 18 cm / 7"
Normal Profile
Normal Profil
Profil Normal

Semken



Smooth
Glett
Lisas

VAB337515T
15 cm / 6"



De Bakery

0.2
VAB338015T 15 cm / 6"
VAB338019T 19 cm / 7 1/2"
VAB338024T 24 cm / 9 1/2"
Micro Profile
Mikro Profil
Profil Micro

0.4
VAB338115T 15 cm / 6"
VAB338119T 19 cm / 7 1/2"
VAB338124T 24 cm / 9 1/2"
Mini Profile
Mini Profil
Profil Mini

پنست ها



SQS Certificate
ISO 9001:2000
ISO 13485:2003





Dressing &
Tissue Forceps
Dissecting Forceps
Pinzetten
Pinzas De Diseccon

پنست ها



CE

SQS Certificate
ISO 9001:2000
ISO 13485:2003

96



Gruenwald
VAB338518T
18 cm / 7"



Mini Profile
Mini Profil
Profil Mini



Wangenstein



0.5
VAB339015T
15 cm / 6"



0.5
VAB339023T
23 cm / 9"



0.5
VAB339025T
25 cm / 10"

Normal Profile
Normal Profil
Profil Normal



0.4
VAB339514T
14.5 cm / 5 7/8"



0.4
VAB339518T
18 cm / 7"

Mini Profile
Mini Profil
Profil Mini



0.4
VAB340020T
20 cm / 8"



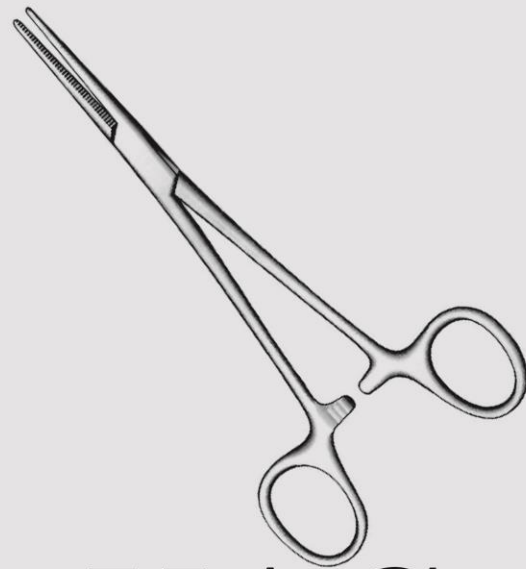
0.4
VAB340025T
25 cm / 10"

Mini Profile
Mini Profil
Profil Mini



VAB340523T
23 cm / 9"

DIAMOND SURGICAL
WWW.DIAMONDMED.IR INSTRUMENTS



VAC
Artery Forceps



CE

SQS Certificate
ISO 9001:2000
ISO 13485:2003

97



Artery Forceps
Bulldog Clamps
Bulldogklemmen
Clamps Bulldog



VAC300103
3.5 cm / 1 1/2"



VAC300503
3.5 cm / 1 1/2"



VAC301004
4.5 cm / 1 3/4"



VAC301504
4.5 cm / 1 3/4"

پنست ها



Dieffenbach
VAC303505
5.8 cm / 2 1/4"



Johns-Hopkins
VAC304005 5 cm / 2" VAC304505
VAC304006 6.5 cm / 2 1/2" VAC304506
VAC304007 7.5 cm / 3" VAC304507



CE

SQS Certificate
ISO 9001:2000
ISO 13485:2003

98



Dieffenbach
VAC302003
VAC302004



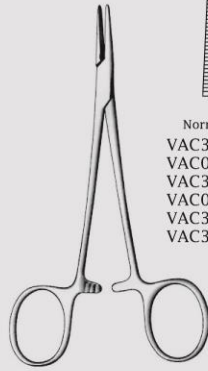
Dieffenbach
VAC302503
VAC302504



Dieffenbach
VAC303005
5.8 cm / 2 1/4"



Artery Forceps
Arterienklemmen
Pinzas Hemostaticas



Halsted-Mosquito
Normal



Normal

VAC305009 9 cm / 3½"
VAC040710 10 cm / 4"
VAC305012 12 cm / 4¾"
VAC041112 12.5 cm / 5"
VAC305018 18 cm / 7"
VAC305020 21 cm / 8¼"



Normal

VAC305109
VAC040810
VAC305112
VAC041212
VAC305118
VAC305120



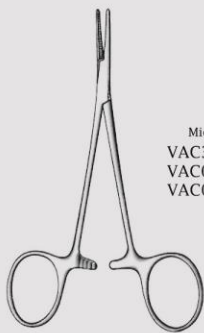
Normal

VAC305209 9 cm / 3½"
VAC305210 10 cm / 4"
VAC305212 12 cm / 4¾"
VAC041312 12.5 cm / 5"
VAC305218 18 cm / 7"
VAC305220 21 cm / 8¼"
1:2 Teeth



Normal

VAC305309
VAC305310
VAC305312
VAC041512
VAC305318
VAC305320
1:2 Teeth



Micro-Mosquito



Micro

VAC305509 9 cm / 3½"
VAC042110 10 cm / 4"
VAC042112 12 cm / 4¾"



Micro

VAC305609
VAC042210
VAC042212



Micro

VAC305709 9 cm / 3½"
VAC042310 10 cm / 4"
VAC042312 12 cm / 4¾"
1:2 Teeth



Micro

VAC305809
VAC042410
VAC042412
1:2 Teeth

پنس ها



CE

SQS Certificate
ISO 9001:2000
ISO 13485:2003

99



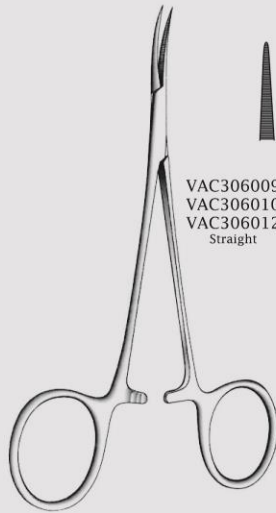
Artery Forceps
 Artery Forceps
 Arterienklemmen
 Pinzas Hemostaticas

پنست ها



CE

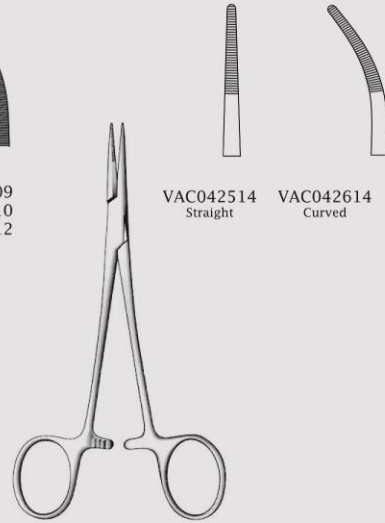
SQS Certificate
 ISO 9001:2000
 ISO 13485:2003



Mosquito
 Extra extra micro

VAC306009 9 cm / 3½"
 VAC306010 10 cm / 4"
 VAC306012 12 cm / 4¾"
 Straight

VAC306109
 VAC306110
 VAC306112
 Curved

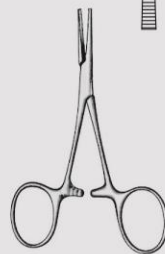


Providence-Hospital
 14 cm / 5½"

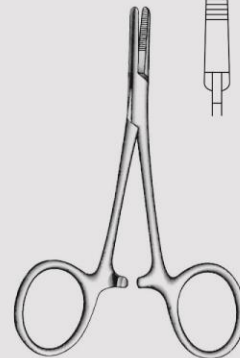
VAC042514 Straight
 VAC042614 Curved



Carrel
 VAC306510
 10 cm / 4"



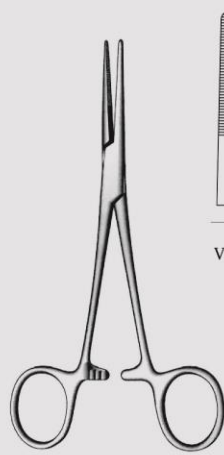
Terrier
 VAC307010
 10 cm / 4"
 1:2 Teeth



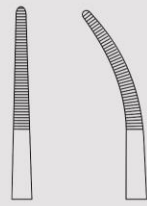
Terrier
 VAC307512
 12 cm / 4¾"



Artery Forceps
Artery Forceps
Arterienklemmen
Pinzas Hemostaticas



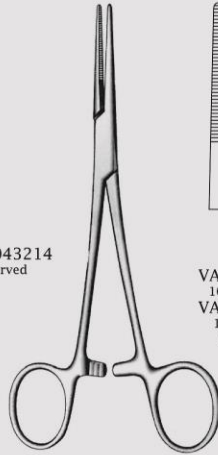
Kelly
14 cm / 5½"



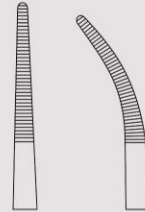
VAC043114
Straight



VAC043214
Curved

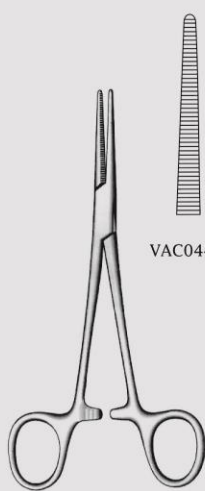


Kelly-Rankin

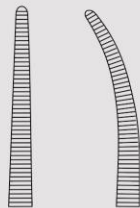


VAC043516
16 cm / 6¼"
VAC308018
18 cm / 7"
Straight

VAC043616
16 cm / 6¼"
VAC308118
18 cm / 7"
Curved

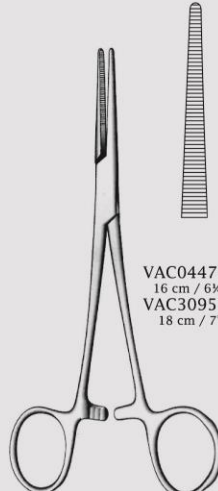


Crile
14 cm / 5½"

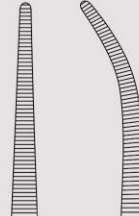


VAC044114

VAC044214

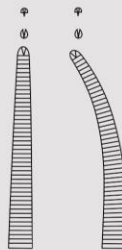


Crile-Rankin



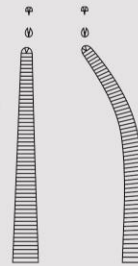
VAC044716
16 cm / 6¼"
VAC309518
18 cm / 7"

VAC044816
16 cm / 6¼"
VAC309618
18 cm / 7"



VAC308514
1:2 Teeth

VAC308614
1:2 Teeth



VAC309016
16 cm / 6¼"
VAC309718
18 cm / 7"
1:2 Teeth

VAC309116
16 cm / 6¼"
VAC309818
18 cm / 7"
1:2 Teeth

پنس ها



CE

SQS Certificate
ISO 9001:2000
ISO 13485:2003

101



Artery Forceps

Artery Forceps, Delicate
Arterienklemmen
Pinzas Hemostaticas

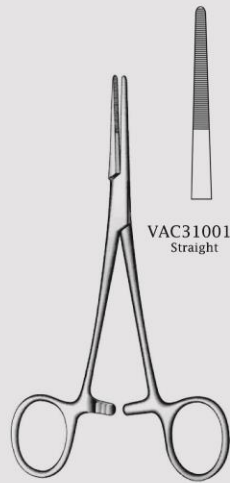
پنس ها



CE

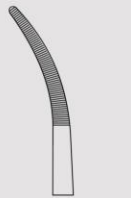
SQS Certificate
ISO 9001:2000
ISO 13485:2003

102

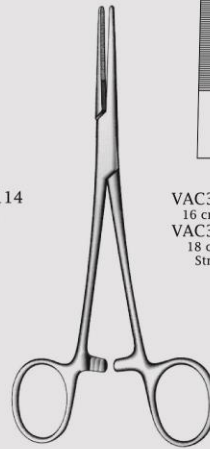


Kelly
14 cm / 5½"
Delicate

VAC310014
Straight



VAC310114
Curved



Kelly-Rankin
Delicate

VAC310516
16 cm / 6¼"
VAC310518
18 cm / 7"
Straight



VAC310616
16 cm / 6¼"
VAC310618
18 cm / 7"
Curved

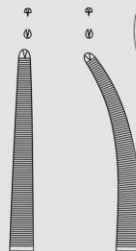


Crile
14 cm / 5½"
Delicate

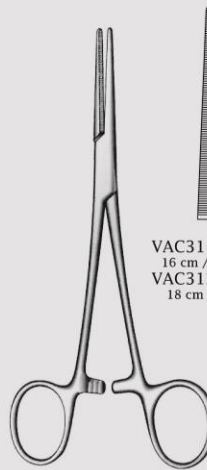
VAC311014



VAC311114



VAC311214
1:2 Teeth

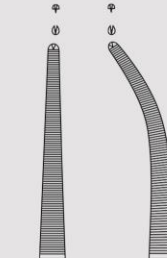


Crile-Rankin
Delicate

VAC311516
16 cm / 6¼"
VAC312018
18 cm / 7"



VAC311616
16 cm / 6¼"
VAC312118
18 cm / 7"

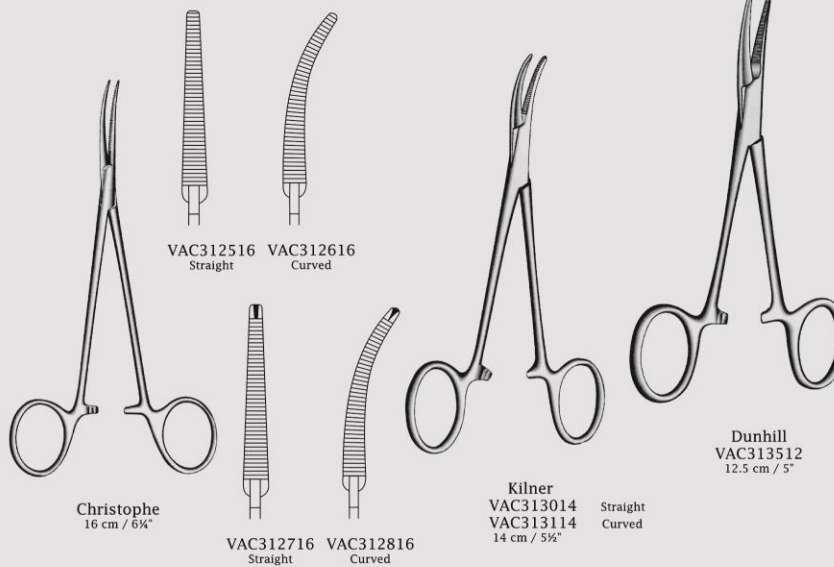
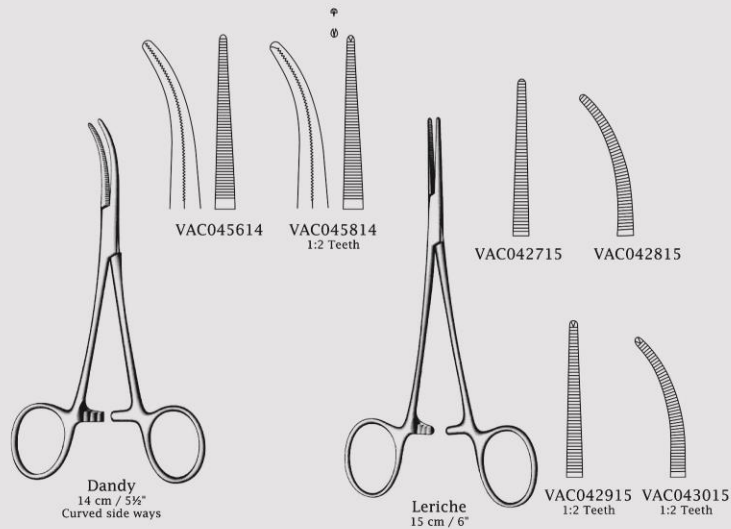


VAC311716
16 cm / 6¼"
VAC312218
18 cm / 7"
1:2 Teeth

VAC311816
16 cm / 6¼"
VAC312318
18 cm / 7"
1:2 Teeth



Artery Forceps
 Arterienklemmen
 Pinzas Hemostaticas



پنس ها



CE

SQS Certificate
 ISO 9001:2000
 ISO 13485:2003

103



Artery Forceps
 Artery Forceps
 Arterienklemmen
 Pinzas Hemostaticas

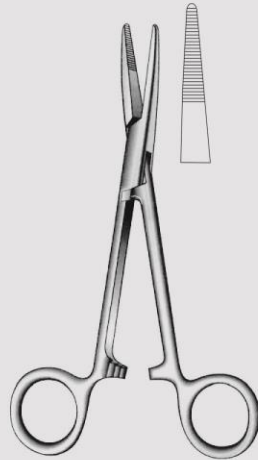
پنس ها



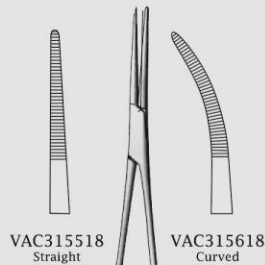
CE

SQS Certificate
 ISO 9001:2000
 ISO 13485:2003

104

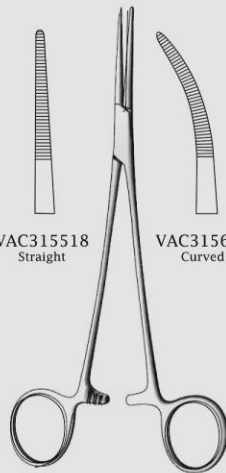


Grey-Turner
 VAC314015 Straight
 VAC314115 Curved
 15 cm / 6"

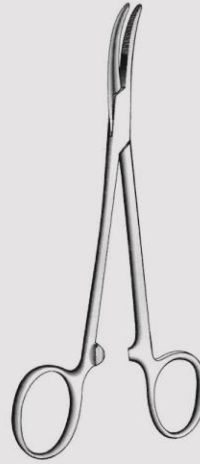


VAC315518
 Straight

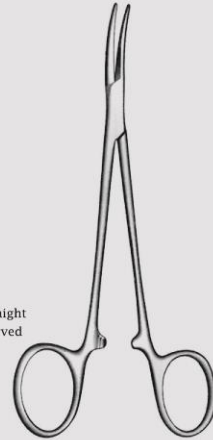
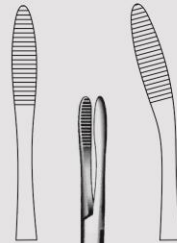
VAC315618
 Curved



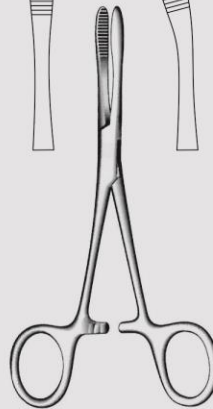
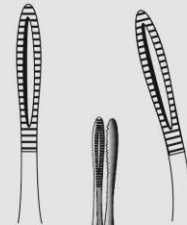
Birkett
 18.5 cm / 7 1/4"



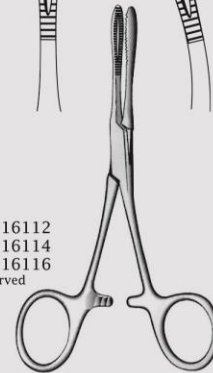
Cairns
 VAC314514 Straight
 VAC314614 Curved
 14.5 cm / 5 3/4"



Cushing
 VAC315014 Straight
 VAC315114 Curved
 14.5 cm / 5 3/4"



Pean
 VAC316012 12.5 cm / 5"
 VAC316014 14 cm / 5 1/2"
 VAC316016 16 cm / 6 1/4" Straight
 VAC316112 Curved
 VAC316114
 VAC316116

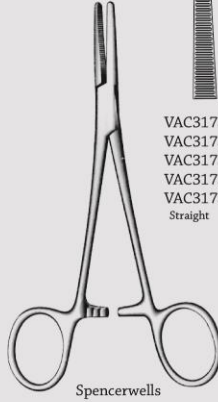


Kroenlien
 VAC316514 Straight
 VAC316614 Curved
 14 cm / 5 1/2"



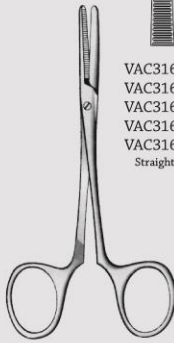
Artery Forceps
 Artery Forceps,
 Haemostatic Forceps
 Arterienklemme
 Pinzas Hemostaticas

VAC317312	12.5 cm / 5"	VAC317412
VAC317315	15 cm / 6"	VAC317415
VAC317318	18 cm / 7"	VAC317418
VAC317320	20 cm / 8"	VAC317420
VAC317323	23 cm / 9"	VAC317423
	Straight	Curved



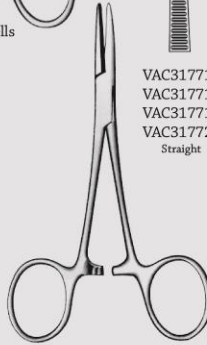
Spencerwells

VAC316912	12.5 cm / 5"	VAC317012
VAC316915	15 cm / 6"	VAC317015
VAC316918	18 cm / 7"	VAC317018
VAC316920	20 cm / 8"	VAC317020
VAC316923	23 cm / 9"	VAC317023
	Straight	Curved



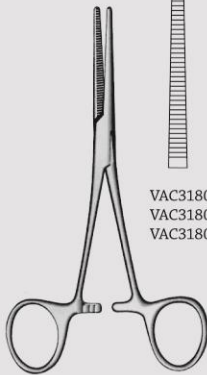
Spencerwells

VAC317712	12.5 cm / 5"	VAC317812
VAC317715	15 cm / 6"	VAC317815
VAC317718	18 cm / 7"	VAC317818
VAC317720	20 cm / 8"	VAC317820
	Straight	Curved

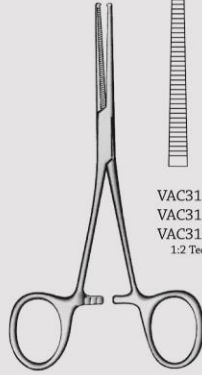


Jones

VAC318013	13.5 cm / 5 1/4"	VAC318113
VAC318014	14.5 cm / 5 3/4"	VAC318114
VAC318017	17 cm / 6 3/4"	VAC318117



VAC318313	13 cm / 5"	VAC318413
VAC318314	14 cm / 5 1/2"	VAC318414
VAC318316	16 cm / 6 1/4"	VAC318416
	1:2 Teeth	1:2 Teeth



پنس ها



CE

SQS Certificate
 ISO 9001:2000
 ISO 13485:2003

105



Artery Forceps
Delicate Artery Forceps
Arterienklemmen
Pinzas hemostaticas

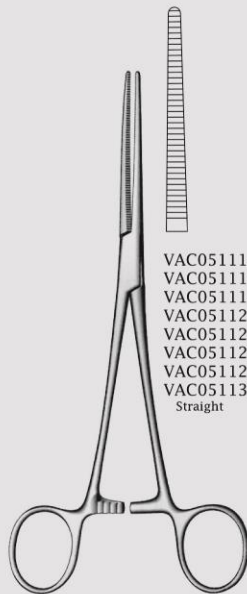
پنس ها



CE

SQS Certificate
ISO 9001:2000
ISO 13485:2003

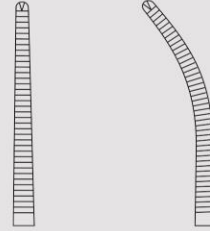
106



Rochester-Pean

VAC051114 14cm/5½"
VAC051116 16cm/6¼"
VAC051118 18cm/7"
VAC051120 20cm/8"
VAC051122 22cm/8¾"
VAC051124 24cm/9½"
VAC051126 26cm/10½"
VAC051130 30cm/12"
Straight

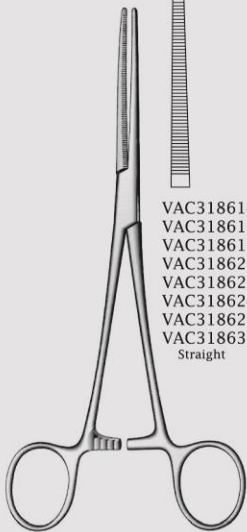
VAC051214
VAC051216
VAC051218
VAC051220
VAC051222
VAC051224
VAC051226
VAC051230
Curved



Rochester-Ochsner

VAC051514 14cm/5½"
VAC051516 16cm/6¼"
VAC051518 18cm/7"
VAC051520 20cm/8"
VAC051522 22cm/8¾"
VAC051524 24cm/9½"
VAC051526 26cm/10½"
VAC051530 30cm/12"
Straight

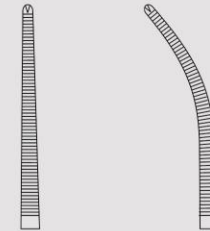
VAC051614
VAC051616
VAC051618
VAC051620
VAC051622
VAC051624
VAC051626
VAC051630
Curved



Rochester-Pean
Delicate

VAC318614 14cm/5½"
VAC318616 16cm/6¼"
VAC318618 18cm/7"
VAC318620 20cm/8"
VAC318622 22cm/8¾"
VAC318624 24cm/9½"
VAC318626 26cm/10½"
VAC318630 30cm/12"
Straight

VAC318714
VAC318716
VAC318718
VAC318720
VAC318722
VAC318724
VAC318726
VAC318730
Curved



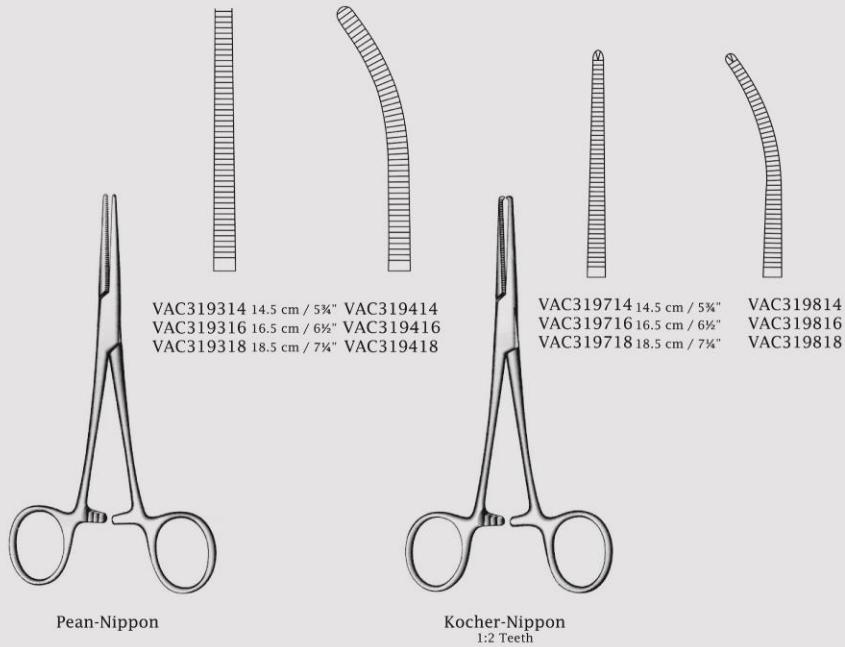
Rochester-Ochsner
Delicate

VAC319014 14cm/5½"
VAC319016 16cm/6¼"
VAC319018 18cm/7"
VAC319020 20cm/8"
VAC319022 22cm/8¾"
VAC319024 24cm/9½"
VAC319026 26cm/10½"
VAC319030 30cm/12"
Straight

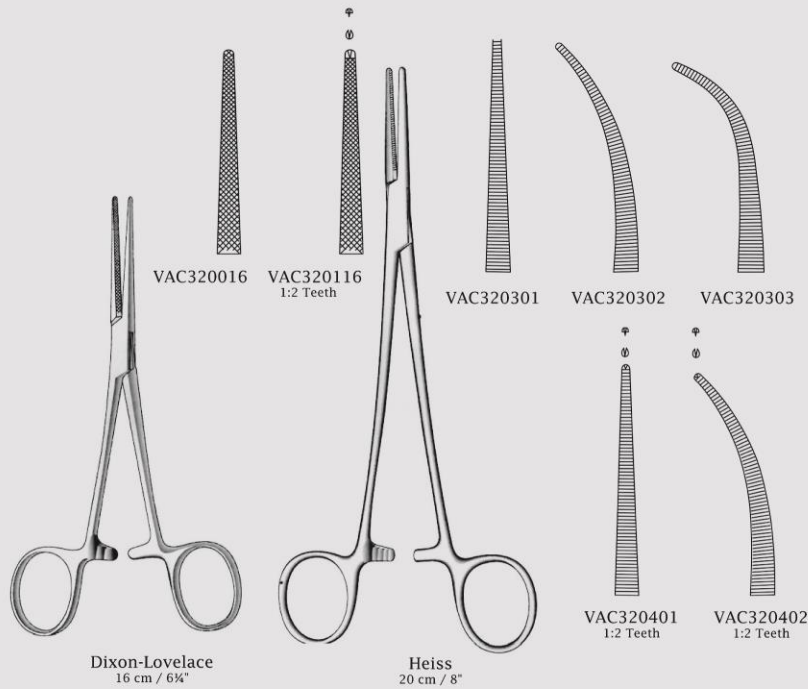
VAC319114
VAC319116
VAC319118
VAC319120
VAC319122
VAC319124
VAC319126
VAC319130
Curved



Artery Forceps
Arterienklemmen
Pinzas Hemostaticas



پنس ها



CE

SQS Certificate
ISO 9001:2000
ISO 13485:2003

107



Artery Forceps
Artery Forceps
Arterienklemmen
Pinzas Hemostaticas

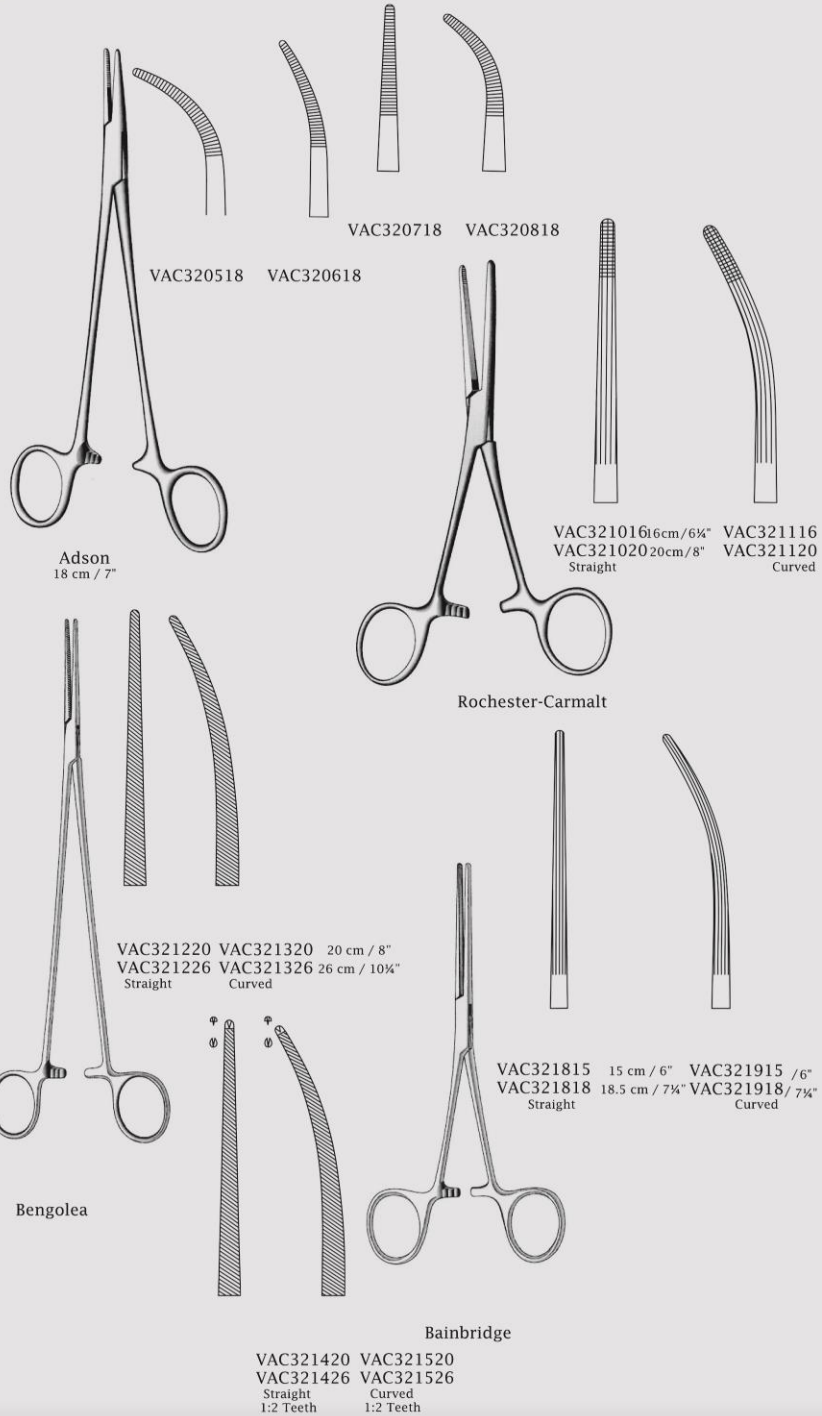
پنس ها



CE

SQS Certificate
ISO 9001:2000
ISO 13485:2003

108

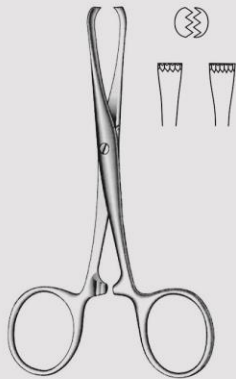




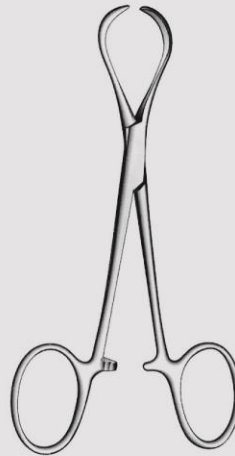
Artery Forceps
Tissue & Organ Grasping Forceps
Gewebe und Organfasszangen
Pinzas para tejidos y para sacar organos



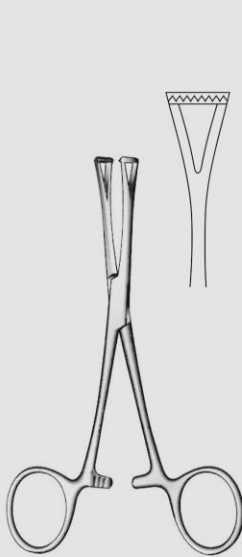
Chaput
VAC322013 13cm/5"
VAC322016 16cm/6½"



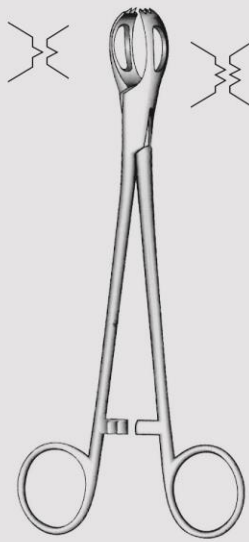
Tuffier
VAC322513
13 cm / 5"



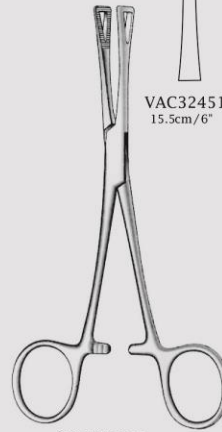
Porrier
VAC323012 12.5 cm / 5"
VAC323018 18 cm / 7"



Collin
VAC323514
14 cm / 5½"



Lahe
VAC324012 12.5 cm / 5" VAC324112
VAC324015 15 cm / 6" VAC324115
VAC324019 19 cm / 7½" VAC324119
1:2 Teeth 2:3 Teeth



Pennington

VAC324515
15.5cm/6"



VAC324520
20cm/8"

پنس ها



CE

SQS Certificate
ISO 9001:2000
ISO 13485:2003

109



Artery Forceps
Tissue & Organ Grasping Forceps
Gewebe und Organfanzangen
para sacar organos
Pinzas para tejidos Y

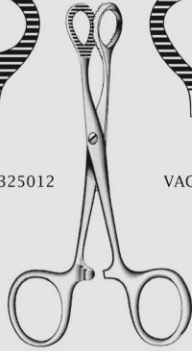
پنسی ها



CE
SQS Certificate
ISO 9001:2000
ISO 13485:2003



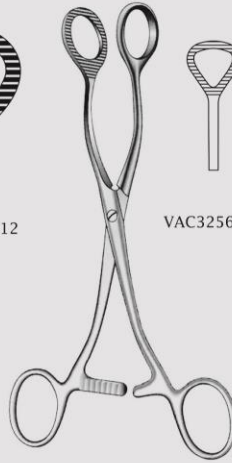
VAC325012



Pean
12 cm / 4 3/4"



VAC325112



Collin
VAC325516
16 cm / 6 1/4"



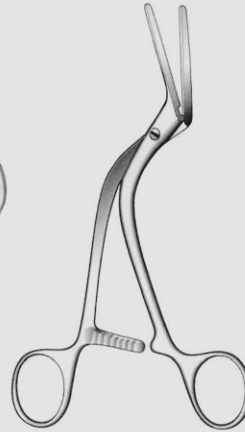
VAC325616



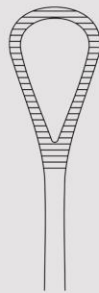
VAC325716



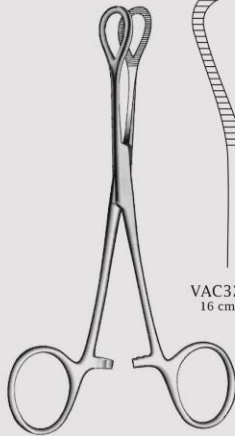
VAC325816



Hopfner
VAC326016
16 cm / 6 1/4"
Vessel clamps



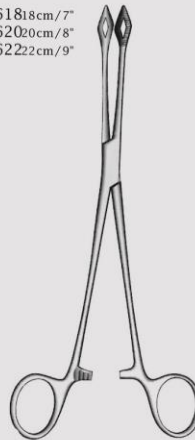
VAC326516
16 cm / 6 1/4"



Coeur



VAC326618 18 cm / 7"
VAC326620 20 cm / 8"
VAC326622 22 cm / 9"



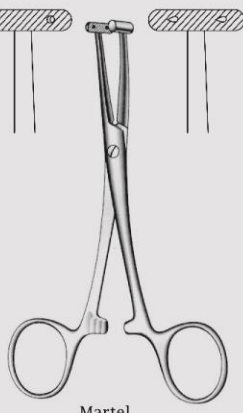
Gregoire



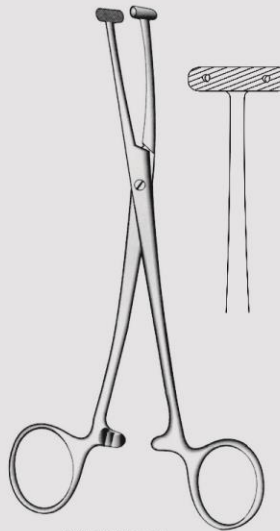
VAC327016 16 cm / 6 1/4"
VAC327018 18 cm / 7"
VAC327020 20 cm / 8"
VAC327022 22 cm / 9"



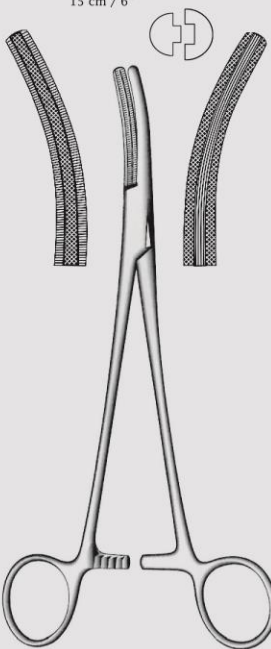
Pratt
VAC327515
15 cm / 6"



Martel
VAC328014
14 cm / 5½"
Face lift forceps



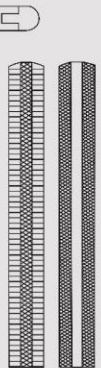
Willet-Martel
VAC328519
19 cm / 7½"



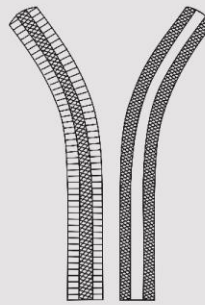
Buie
VAC329021
21 cm / 8¼"



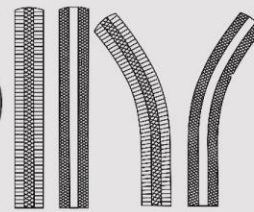
Fergusson



VAC329520
20 cm / 8"



VAC 329620
2 cm / 8"



VAC329517
17 cm / 6¾"

VAC329617
17 cm / 6¾"



Artery Forceps
Tissue, Organ Grasping
Forceps & Angiotribes
Gewebe, Organfasszangen
und Druckklemmen
Tejidos, Sacar organos Y
para clamp de presion progresiva

پنس ها



CE

SQS Certificate
ISO 9001:2000
ISO 13485:2003

111



Artery Forceps
and Ligature Forceps
Artery Forceps, Dissecting
Arterienklemmen, Präparierklemmen
Pinzas para preparaciones Y ligaduras
Pinzas hemostaticas,

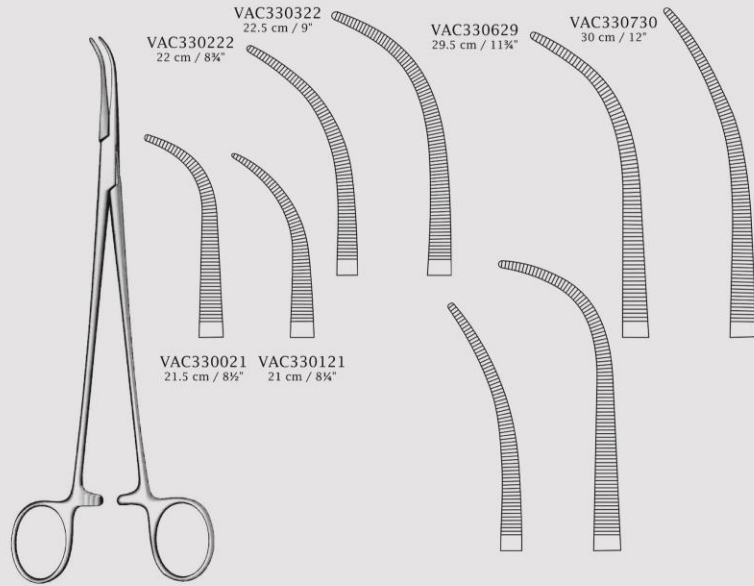
پنس ها



CE

SQS Certificate
ISO 9001:2000
ISO 13485:2003

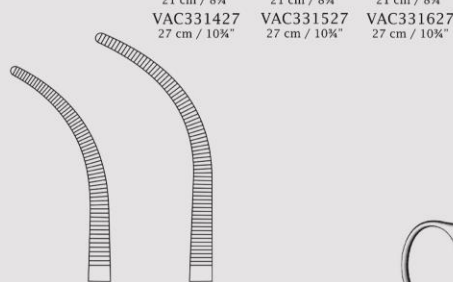
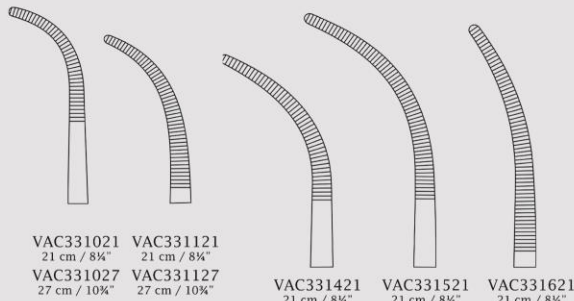
112



Overholt
Fine pattern

VAC330422 22.5 cm / 9"

VAC330529 29.5 cm / 11 3/4"

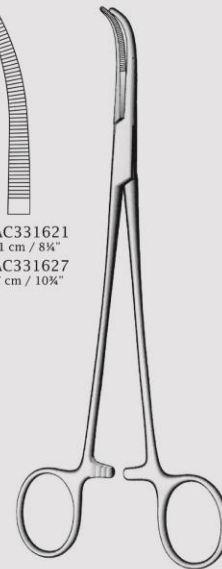


VAC331221 21 cm / 8 1/4"

VAC331321 21 cm / 8 1/4"

VAC331227 27 cm / 10 3/4"

VAC331327 27 cm / 10 3/4"

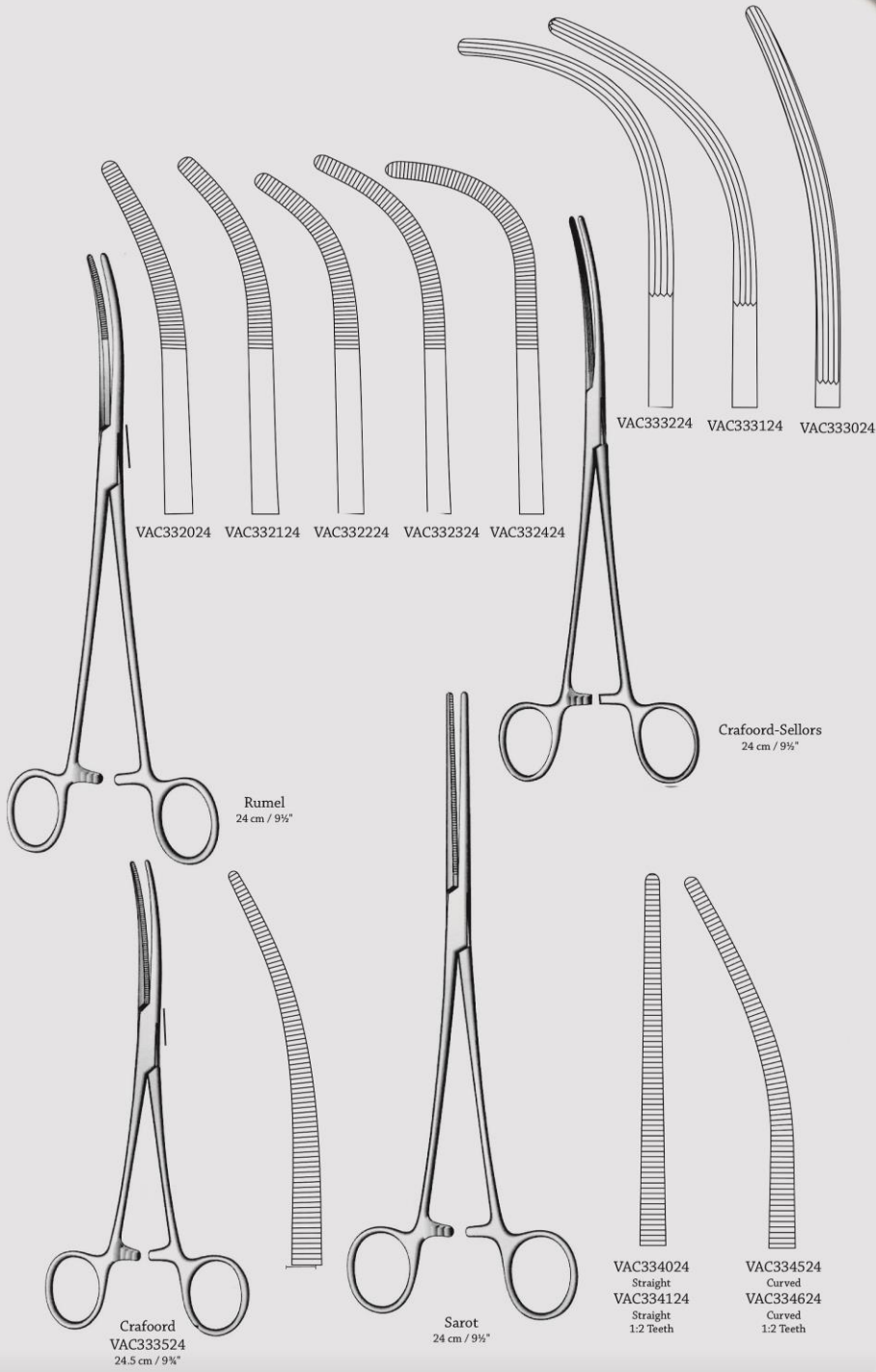


Overholt-Geissendoerfer



Artery Forceps

Dissecting & Ligature Forceps
Präparierklemmen
Pinzas para preparaciones y ligaduras



پنس ها



CE

SQS Certificate
ISO 9001:2000
ISO 13485:2003

113



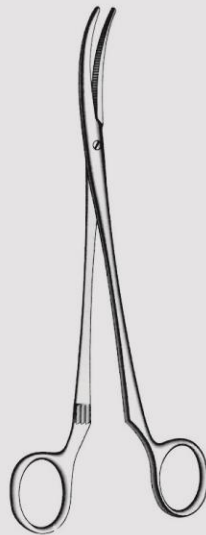
Artery Forceps
 Dissecting and Ligature Forceps
 Präparierklemmen
 Pinzas para Preparaciones Y ligaduras

پنس ها

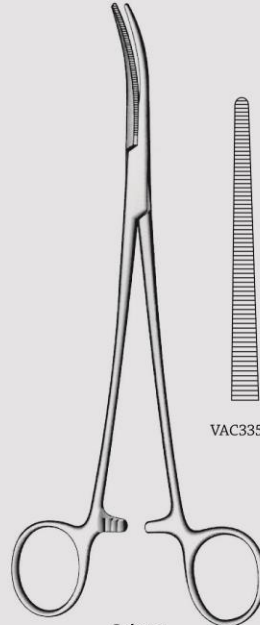


SQS Certificate
 ISO 9001:2000
 ISO 13485:2003

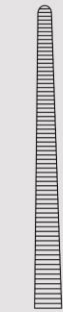
114



Roberts
 VAC335023 Straight
 VAC335123 Curved
 23 cm / 9"



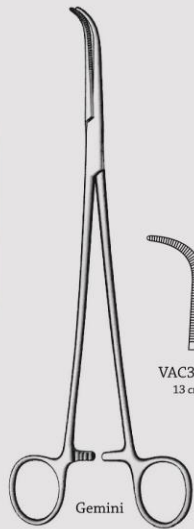
Roberts
 22 cm / 8 3/4"



VAC335522



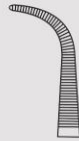
VAC335622



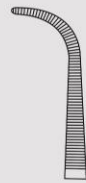
Gemini



VAC336013
 13 cm / 5"



VAC336116
 16 cm / 6 3/4"



VAC336218
 18 cm / 7"



VAC336320
 20 cm / 8"



VAC336423
 23 cm / 9"



VAC336525
 25 cm / 10"



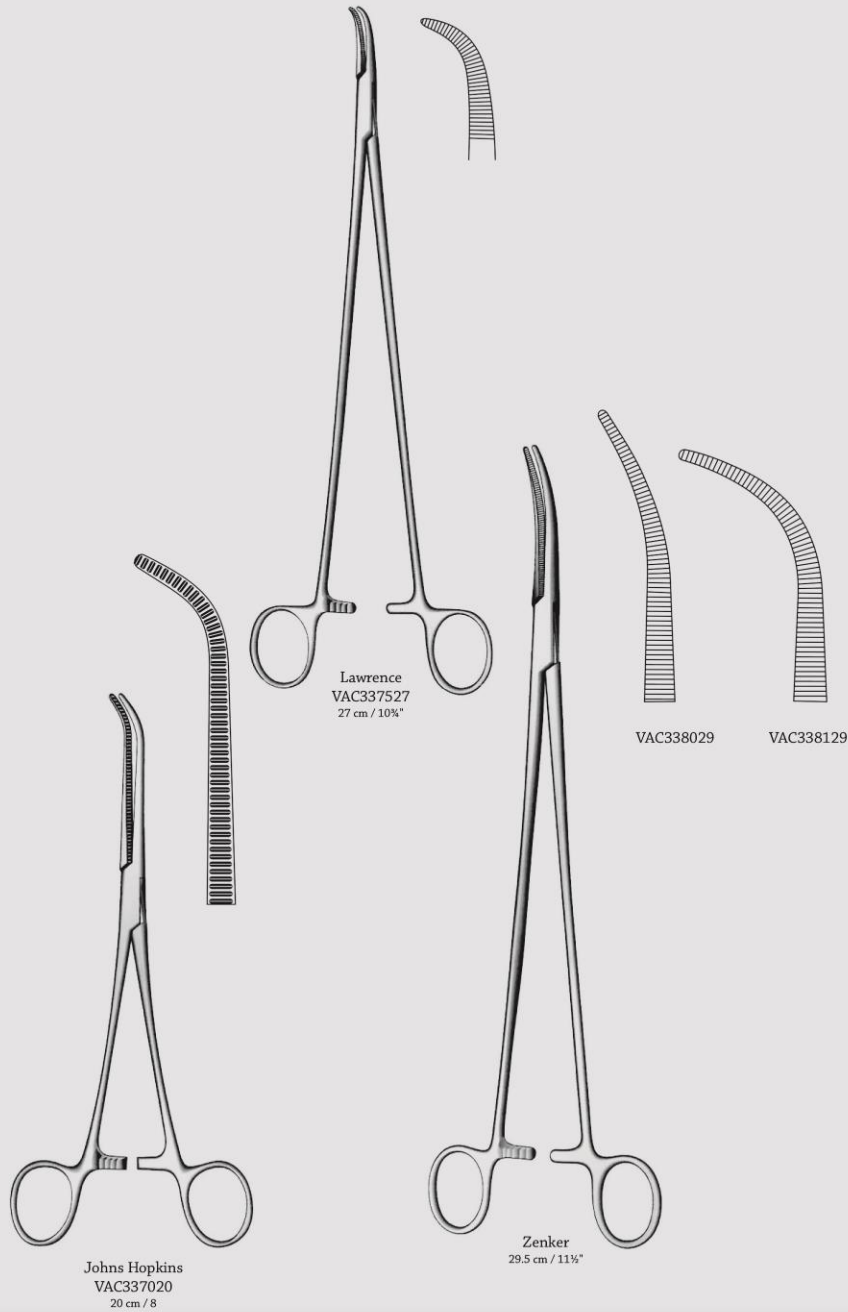
VAC336628
 28 cm / 11"



Artery Forceps

Dissecting & Ligature Forceps
Praparierenklemmen
Pinzas para preparaciones y ligaduras

پنس ها



CE

SQS Certificate
ISO 9001:2000
ISO 13485:2003





Artery Forceps

Dissecting and Ligature Forceps
Präparierklemmen
Pinzas para Preparaciones Y ligaduras

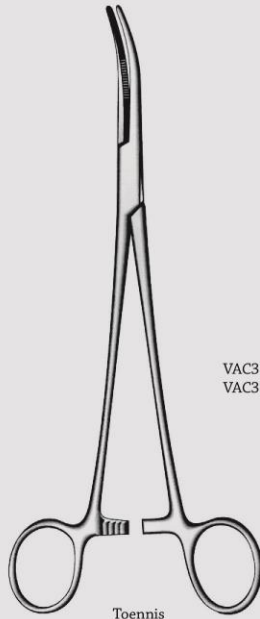
پنس ها



CE

SQS Certificate
ISO 9001:2000
ISO 13485:2003

116



Toennis



VAC338521 21 cm / 8 1/4"
VAC338526 26 cm / 10 1/4"



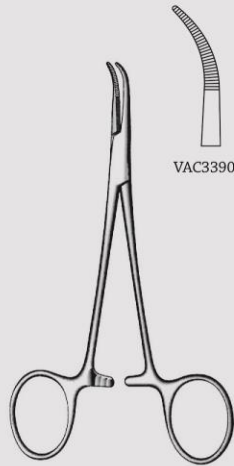
VAC338621
VAC338626



VAC338721 21 cm / 8 1/4"
VAC338726 26 cm / 10 1/4"
1:2 Teeth



VAC338821
VAC338826
1:2 Teeth



Baby-Mixer
14 cm / 5 1/2"



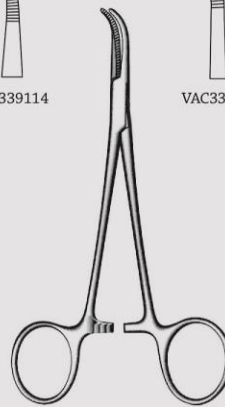
VAC339014



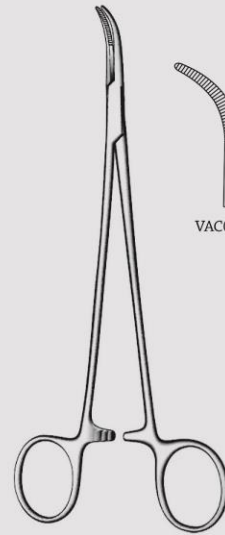
VAC339114



VAC339514



Mixer
14 cm / 5 1/2"



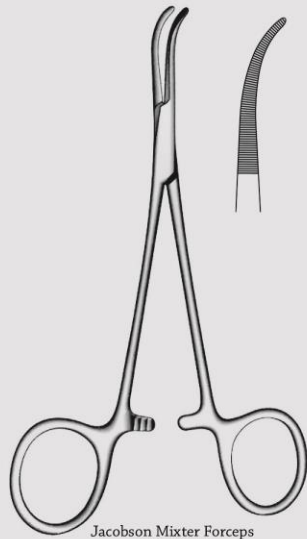
Mixer-Baby
18 cm / 7"



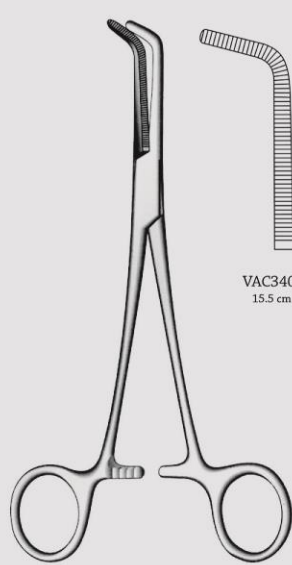
VAC052018



Artery Forceps
Dissecting and Ligature Forceps
Preparienklemmen
Pinzas para Preparaciones Y ligaduras



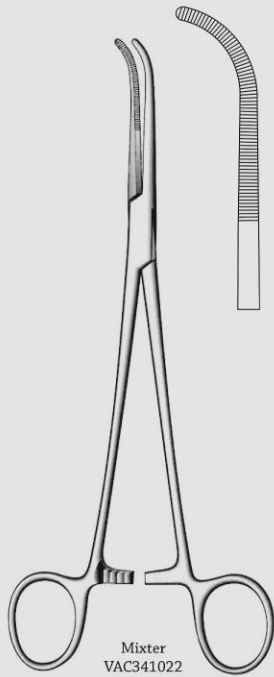
Jacobson Mixer Forceps
VAC340015
15.5 cm / 6"
Extra delicate



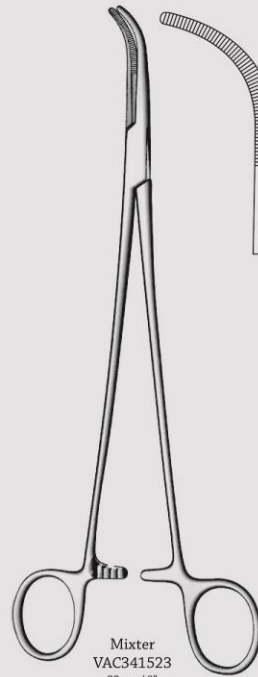
Mixer

VAC340515
15.5 cm / 6"

VAC340518
18 cm / 7"



Mixer
VAC341022
22 cm / 8 1/2"



Mixer
VAC341523
23 cm / 9"

پنس ها



CE

SQS Certificate
ISO 9001:2000
ISO 13485:2003

117



Artery Forceps
 , Bile Duct Clamps
 Dissecting & Ligature Forceps
 Gallenkanaklemmen
 Präparienklemmen,
 Pinzas pra preparacion y ligadura,
 Pinzas para conducto biliar

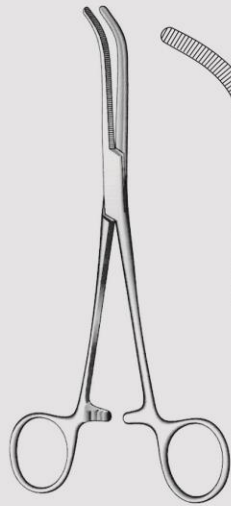
پنس ها



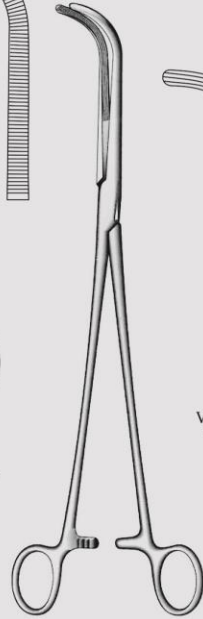
CE

SQS Certificate
 ISO 9001:2000
 ISO 13485:2003

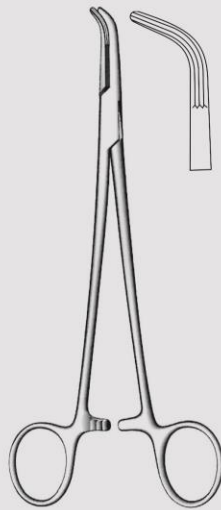
118



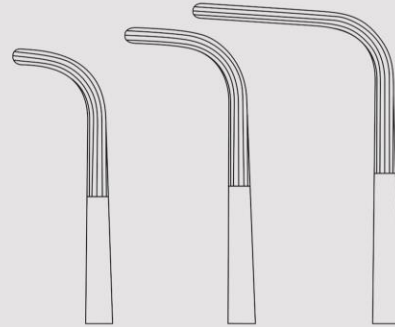
Mixer-O, Shaugnessy
 VAC342018
 18 cm / 7"



Mixer



Lower
 VAC343018
 18 cm / 7"



VAC342522
 22 cm / 8 3/4"

VAC342525
 25 cm / 10"

VAC342528
 28 cm / 11"



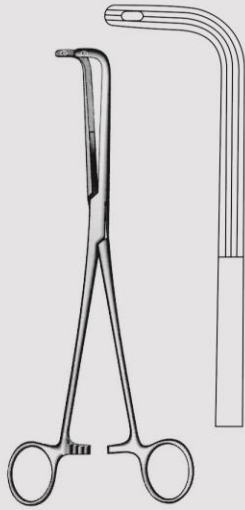
Lahey

VAC343519
 19 cm / 7 1/2"

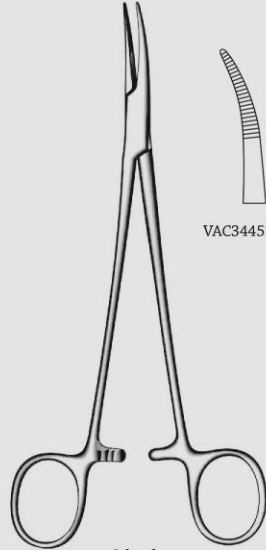
VAC343523
 23 cm / 9"



Artery Forceps
Dissecting & Ligature Forceps,
Haemostatic Forceps
Praparienklemmen, Arterienklemmen
Pinzas pra preparacion y ligadura,
Pinzas hemostaticas



Finocchetto
VAC344024
24 cm / 9 1/2"



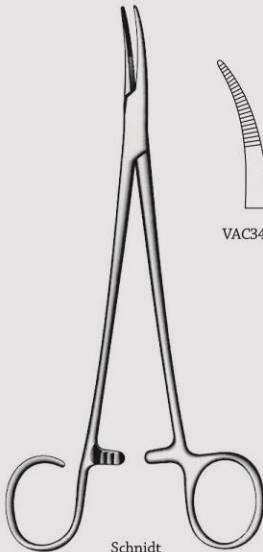
Schnidt
19 cm / 7 1/2"



VAC344519



VAC344619



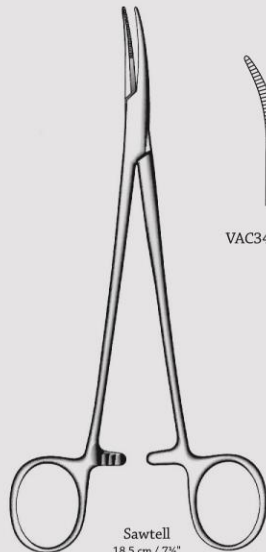
Schnidt
19 cm / 7 1/2"



VAC345019



VAC345119



Sawtell
18.5 cm / 7 3/8"



VAC345518



VAC345618

پنس ها



CE

SQS Certificate
ISO 9001:2000
ISO 13485:2003

119



Artery Forceps
 Artery Forceps, Kidney
 Pedicle Clamp Forceps
 Arterienklemmen,
 Nierenstieklemmen
 Pinzas Hemostaticas, Pinzas-Clamps
 Para Pedunculos Renales

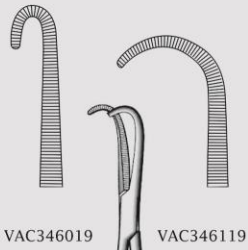
پنس ها



CE

SQS Certificate
 ISO 9001:2000
 ISO 13485:2003

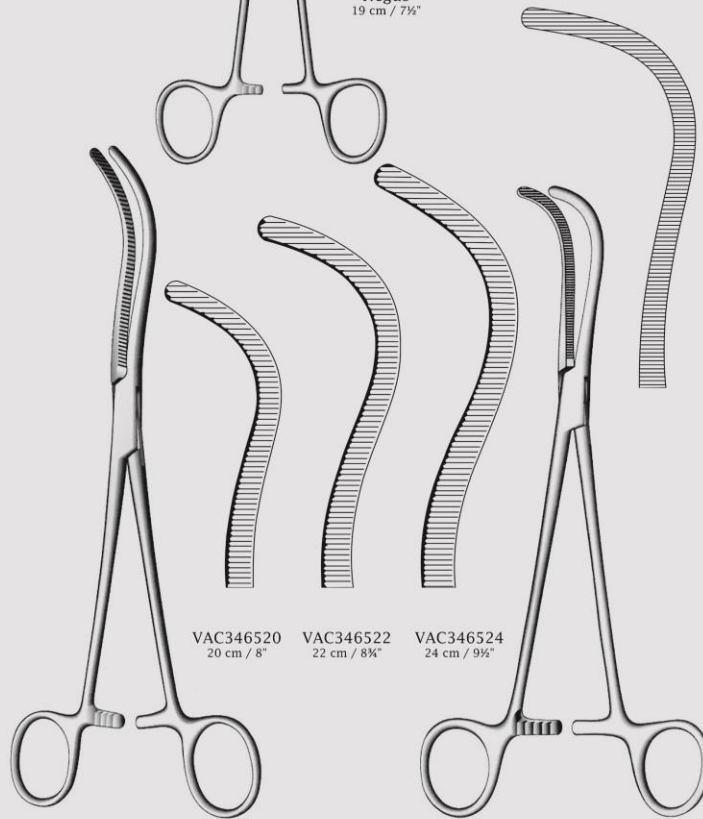
120



VAC346019

VAC346119

Negus
 19 cm / 7 1/2"



VAC346520
 20 cm / 8"

VAC346522
 22 cm / 8 1/4"

VAC346524
 24 cm / 9 1/2"

Guyon

Guyon
 VAC347023
 23 cm / 9"



Artery Forceps

Kidney Pedicle Clamp Forceps
Nierenstieklemmen
Pinzas-Clamps Para Pedunculos Renales

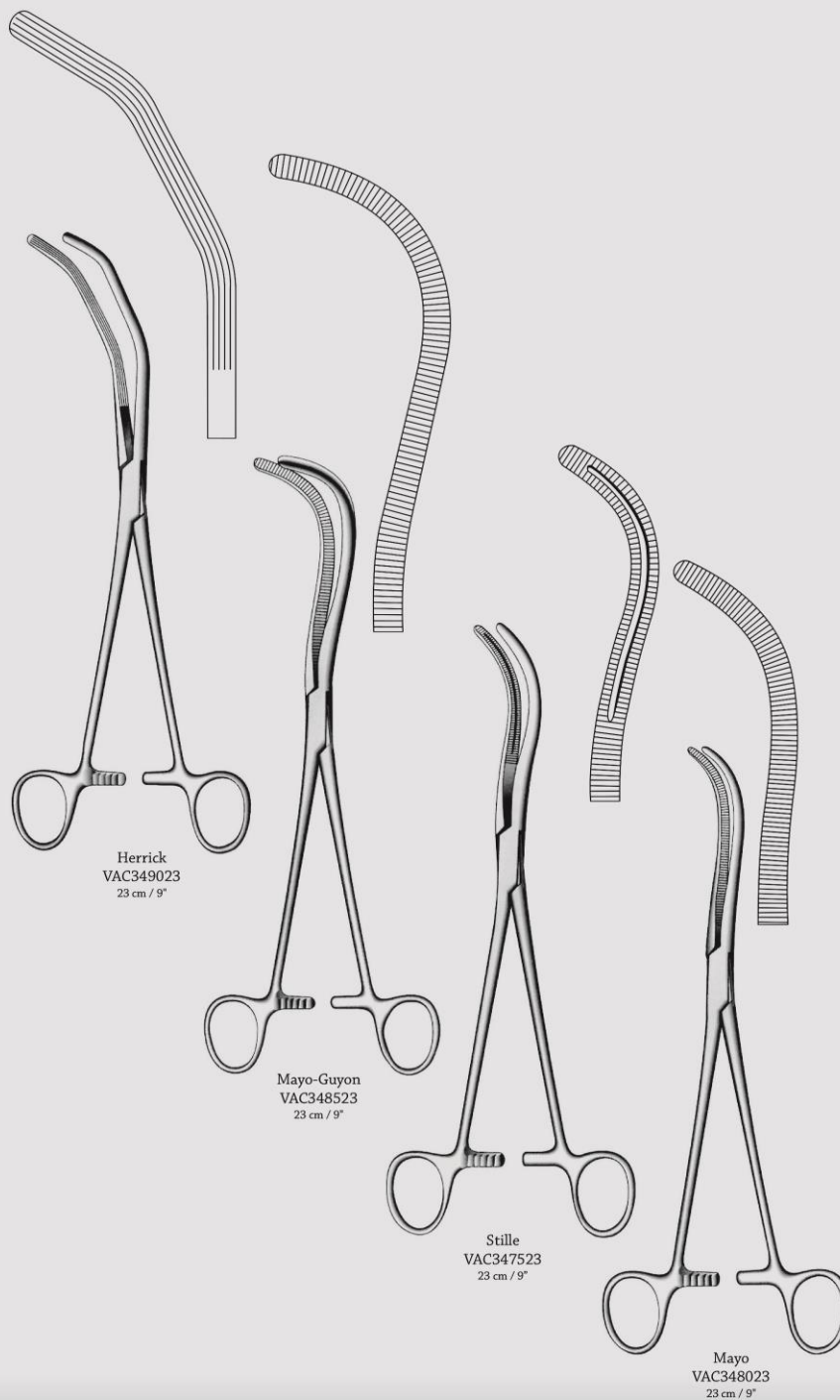
پنس ها



CE

SQS Certificate
ISO 9001:2000
ISO 13485:2003

121



Herrick
VAC349023
23 cm / 9"

Mayo-Guyon
VAC348523
23 cm / 9"

Stille
VAC347523
23 cm / 9"

Mayo
VAC348023
23 cm / 9"



Artery Forceps
Gall Duct Clamps
Gallenkanalklemmen
Pinzas Para Conducto Billar

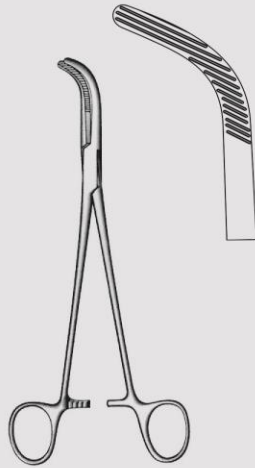
پنس ها



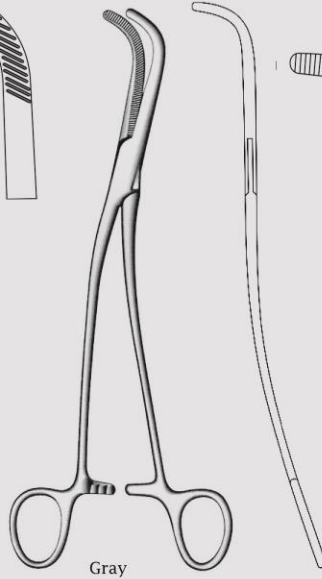
CE

SQS Certificate
ISO 9001:2000
ISO 13485:2003

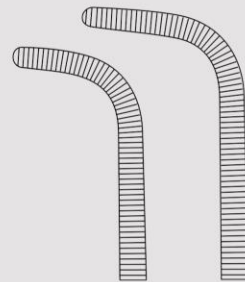
122



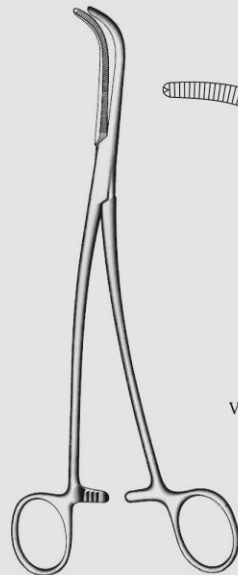
Crile
VAC349520
20 cm / 8"



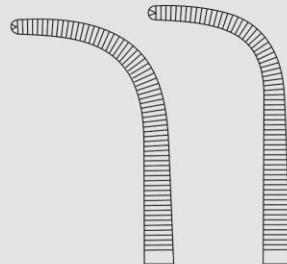
Gray



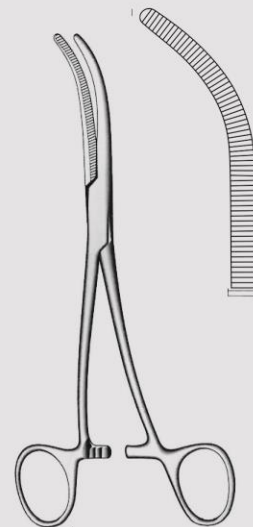
VAC350022 22 cm / 8 1/4"
VAC350023 23 cm / 9"



Gray



VAC350522 22 cm / 8 1/4"
VAC350523 23 cm / 9"



Dean-Shallcross
VAC351018
18 cm / 7"



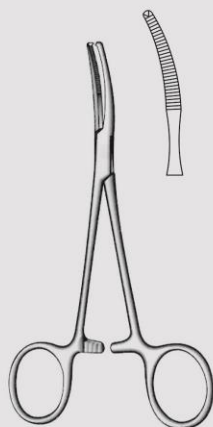
Artery Forceps
Gall Duct Clamps,
Peritoneal Clamp Forceps
Gallenkanaklemmen,
Peritoneumklemmen
Pinzas para conducto biliar,
Pinzas-Clamps Para Peritoneo



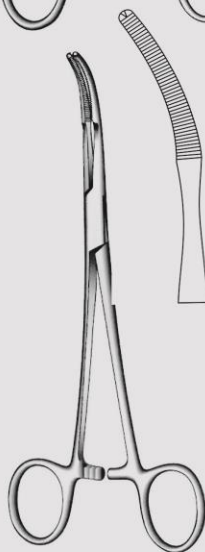
Desjardins
VAC351521
21 cm / 8 3/4"



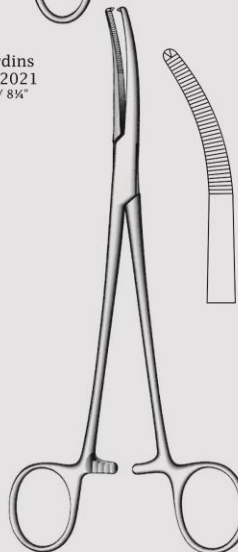
Desjardins
VAC352021
21 cm / 8 3/4"



Baby-Mikulicz
VAC352514
14 cm / 5 1/2"



Mikulicz
VAC353020
20 cm / 8"



Mikulicz
VAC353520
20 cm / 8"

پنس ها



CE

SQS Certificate
ISO 9001:2000
ISO 13485:2003

123



Artery Forceps
 Hysterectomy & Vaginal Clamp Forceps
 Hysterektomieklammen, Vaginalklammen
 Pinzas-clamps para histerectomia y vaginales

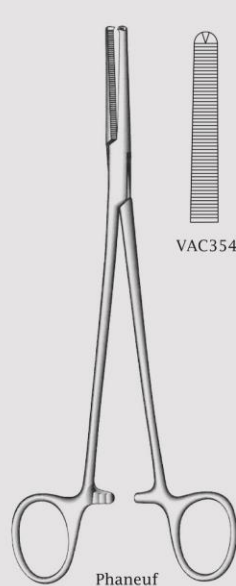
پنس ها



CE

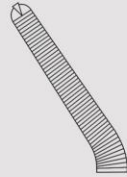
SQS Certificate
 ISO 9001:2000
 ISO 13485:2003

124

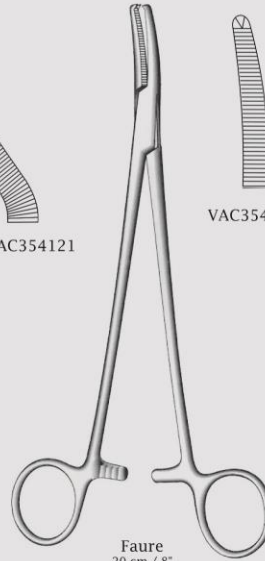


Phaneuf
 21 cm / 8 1/4"
 1:2 Teeth

VAC354021



VAC354121



Faure
 20 cm / 8"
 1:2 Teeth

VAC354520



VAC354620



Wertheim
 1:2 Teeth

VAC355022
 22 cm / 8 3/4"
 Slightly curved



VAC355023
 23 cm / 9"
 More curved



Wertheim
 1:2 Teeth

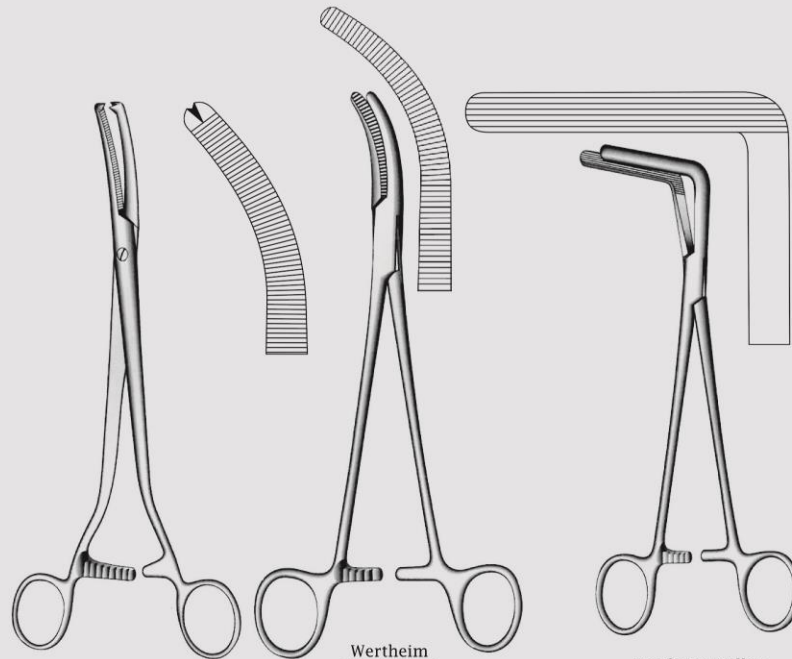
VAC355522
 22 cm / 8 3/4"
 Slightly curved



VAC355523
 23 cm / 9"
 More curved



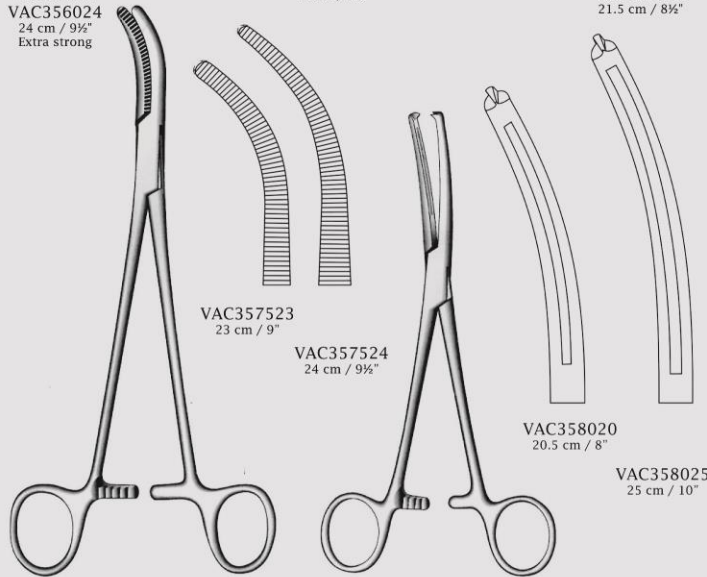
Artery Forceps
 Hysterectomy &
 Vaginal Clamp Forceps
 Hysterektomieklappen,
 Vaginalklappen
 Pinzas-clamps para
 hysterectomia y vaginales



Wertheim
 VAC356024
 24 cm / 9½"
 Extra strong

Wertheim
 VAC356525
 25 cm / 10"

Wertheim Cullen
 VAC357021
 21.5 cm / 8½"



VAC357523
 23 cm / 9"

VAC357524
 24 cm / 9½"

VAC358020
 20.5 cm / 8"

VAC358025
 25 cm / 10"

Moynihan

Maingot

پنس ها



CE

SQS Certificate
 ISO 9001:2000
 ISO 13485:2003

125



Artery Forceps

Hysterectomy & Vaginal Clamp Forceps
Hysterektomieklennen, Vaginalklennen
Pinzas-clamps para histerectomia y vaginales

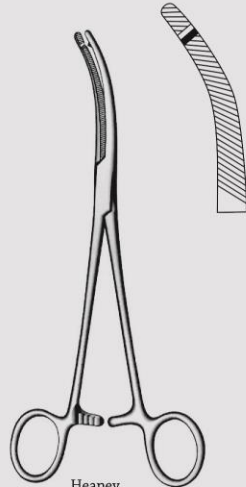
پنس ها



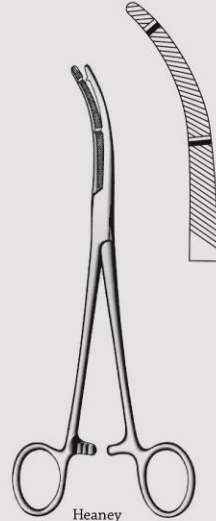
CE

SQS Certificate
ISO 9001:2000
ISO 13485:2003

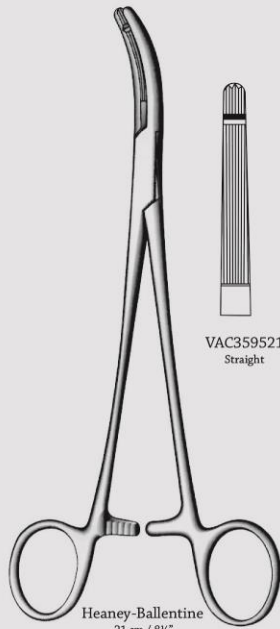
126



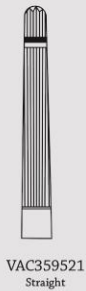
Heaney
VAC358519 19 cm / 7 1/2"
VAC358521 21 cm / 8"
VAC358524 24.5 cm / 9 1/2"
Hysterectomy forceps
Heavy pattern, single tooth
Curved



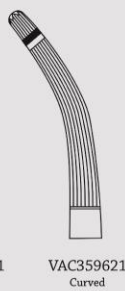
Heaney
VAC359019 19 cm / 7 1/2"
VAC359021 21 cm / 8"
Heavy pattern
VAC359024 24.5 cm / 9 1/2"
Extra heavy pattern
Hysterectomy forceps
double tooth, curved



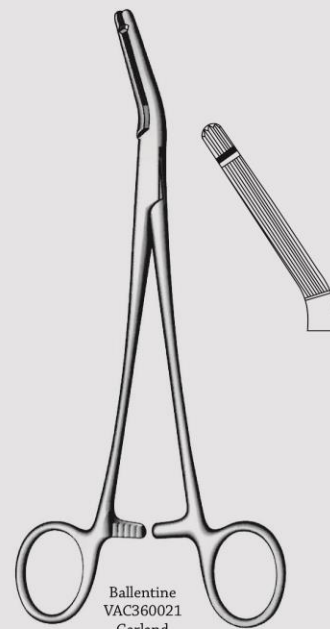
Heaney-Ballentine
21 cm / 8"
Longitudinal serrations, single tooth



VAC359521
Straight



VAC359621
Curved

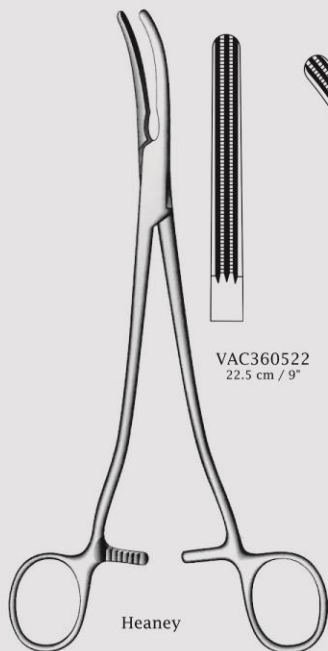


Ballentine
VAC360021
Garland
VAC360121
21 cm / 8"
Longitudinal serrations,
single tooth, angled on flat

ATRAUMA



Artery Forceps
Hysterectomy & Vaginal Clamp Forceps
Hysterektomieklammen, Vaginaalklappen
Pinzas-clamps para histerectomia y vaginales



Heaney

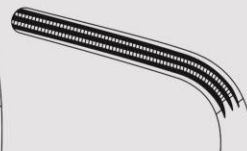
VAC360522
22.5 cm / 9"



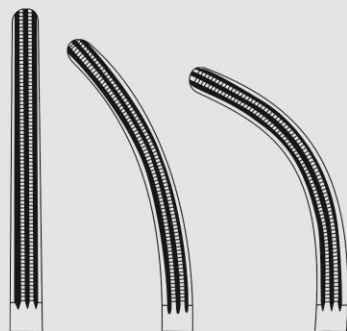
VAC360621
21.5 cm / 8½"



VAC360722
22 cm / 8½"



VAC360820
20.5 cm / 8"

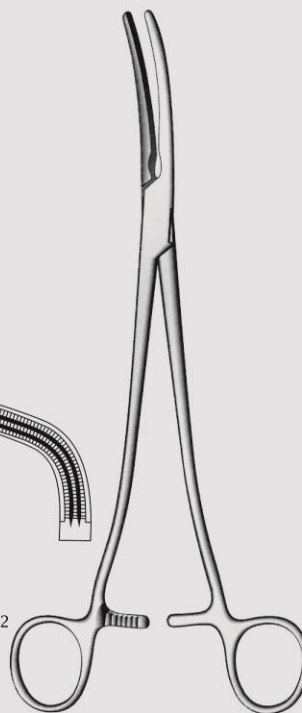


VAC361025
25 cm / 10"

VAC361124
24.5 cm / 9¾"

VAC361224
24 cm / 9½"

VAC361322
22 cm / 8¾"



Wertheim
Parametrium clamps

پنس ها



CE

SQS Certificate
ISO 9001:2000
ISO 13485:2003

127



Artery Forceps
 Hysterectomy &
 Vaginal Clamp Forceps
 Hysterektomieklappen,
 Vaginaklappen
 Pinzas-clamps para
 histerectomia y vaginales

پنس ها

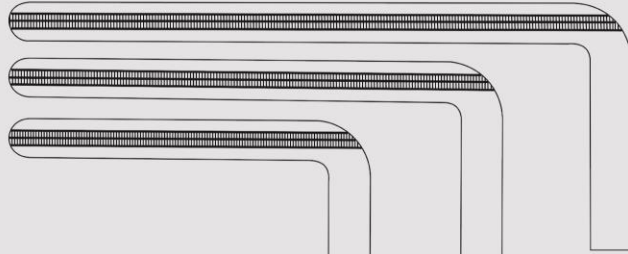


CE

SQS Certificate
 ISO 9001:2000
 ISO 13485:2003

128

ATRAUMA

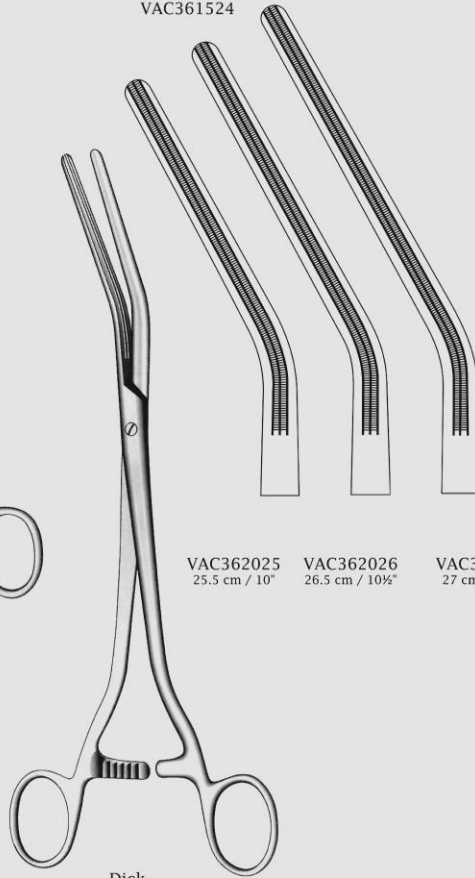


VAC361724



Wertheim
 24 cm / 9 1/2"

VAC361524



VAC362025
 25.5 cm / 10"

VAC362026
 26.5 cm / 10 1/2"

VAC362027
 27 cm / 10 3/4"

Dick



Artery Forceps
Towel Forceps
Tuchklemmen
Pinzas para compresas,
Pinzas de campo



Jones
VAC098205 5 cm / 2"
VAC098209 9 cm / 3½"

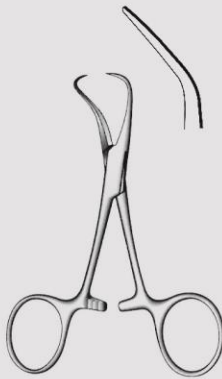


Schaedel
VAC097609
9 cm / 3½"

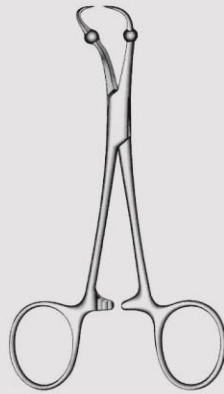


English Model
VAC362509
9 cm / 3½"

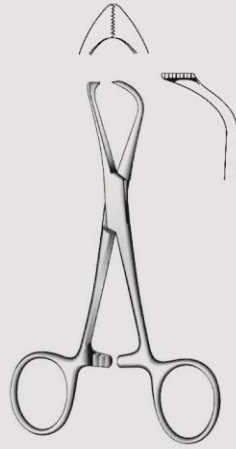
پنس ها



Backhaus
VAC101609 9 cm / 3½"
VAC101611 11 cm / 4¼"
VAC101613 13 cm / 5"
VAC101615 15 cm / 6"



Roeder
VAC363011 11 cm / 4¼"
VAC363013 13 cm / 5"
VAC363015 15 cm / 6"



Lorna
VAC102010 10 cm / 4"
VAC102013 13 cm / 5"



CE

SQS Certificate
ISO 9001:2000
ISO 13485:2003

129



Artery Forceps

Towel Forceps
Tuchklemmen
Pinzas para compresas,
Pinzas de campo

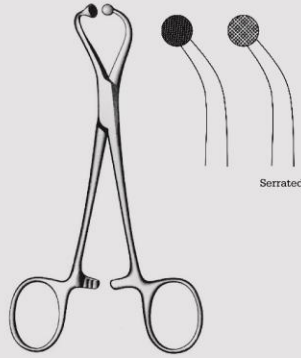
پنس ها



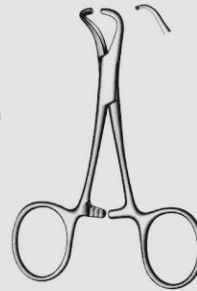
CE

SQS Certificate
ISO 9001:2000
ISO 13485:2003

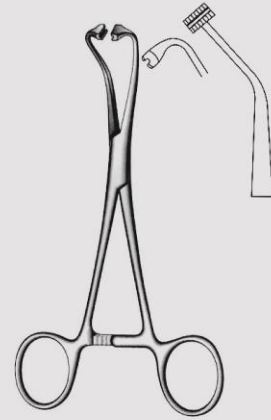
130



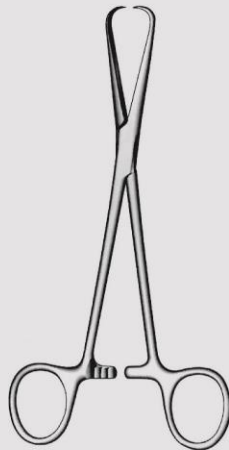
Ball-Socket
VAC363511 11 cm / 4 1/4"
VAC363514 14 cm / 5 1/2"
For paper cloths
VAC363611 11 cm / 4 1/4"
VAC363614 14 cm / 5 1/2"
Serrated



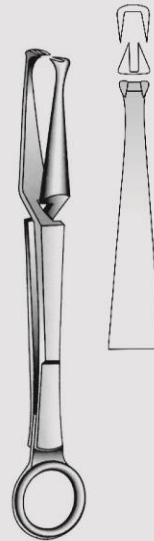
Tohoku
VAC102410 10 cm / 4"
VAC102413 13 cm / 5 1/4"



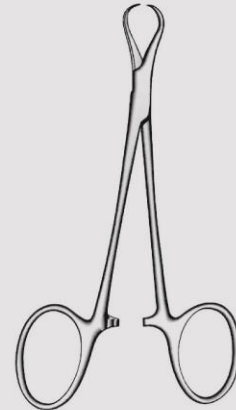
Peer's-Bertram
VAC364015
15 cm / 6"
For paper cloths



Bernhard
VAC364516
16.5 cm / 6 1/2"



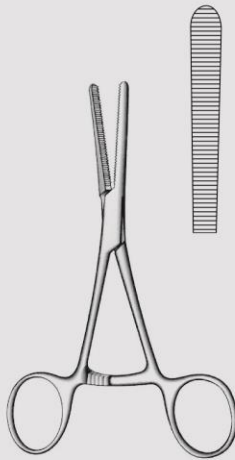
Doyen
VAC365018
18 cm / 7"



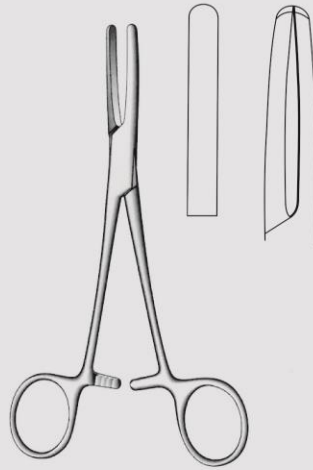
Jayle
VAC365513
13 cm / 5"



Tubing Clamps
 Tubing Clamps
 Schlauchklemmen
 Pinzas para tubos



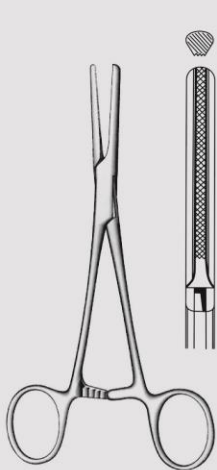
VAC366014
 14.5 cm / 5 1/2"
 With extra long ratchet



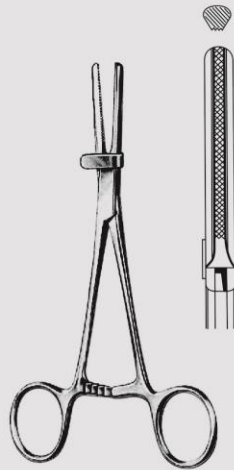
VAC366514 14.5 cm / 5 1/2"
 VAC366516 16 cm / 6 1/4"
 VAC366518 18 cm / 7"



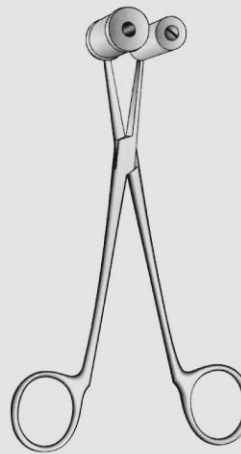
VAC367016
 With stainless steel rollers
 VAC367116
 With teflon rollers
 16 cm / 6 1/4"



Standard
 VAC367514 14 cm / 5 1/2"
 VAC367515 15 cm / 6"
 VAC367518 18 cm / 7"
 VAC367520 20 cm / 8"



VAC368014 14 cm / 5 1/2"
 VAC368015 15 cm / 6"
 VAC368018 18 cm / 7"
 VAC368020 20 cm / 8"
 With guard



Gunnar
 VAC368518
 With stainless steel rollers
 VAC368618
 With teflon rollers
 18.5 cm / 7 1/4"

کلمپ تیوبینگ



SQS Certificate
 ISO 9001:2000
 ISO 13485:2003





Cotton Swab Forceps
 Dressing, Cotton Swab Holding Forceps
 Korn- und Tupferzangen
 Pinzas para Vendajes Y tapones

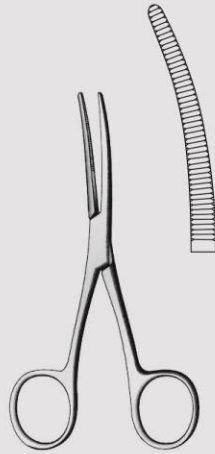
پنس ها



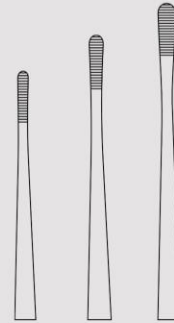
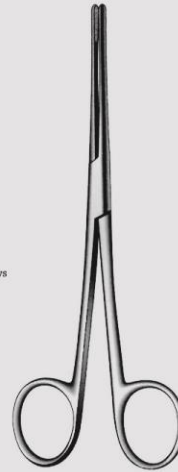
CE

SQS Certificate
 ISO 9001:2000
 ISO 13485:2003

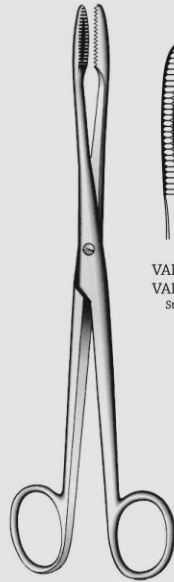
132



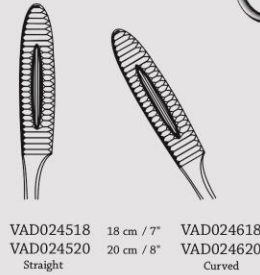
Bryant
 VAD300113
 VAD300213 Serrated jaws
 13 cm / 5 1/4"



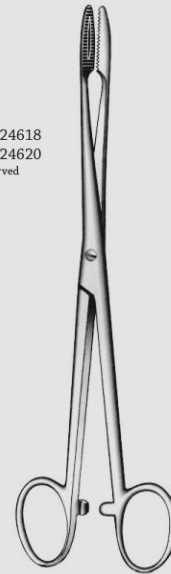
Lister
 VAD300513 13 cm / 5"
 VAD300515 15.5 cm / 6"
 VAD300516 16 cm / 6 1/4"
 VAD300517 17.5 cm / 7"
 Sinus forceps



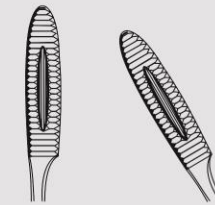
Gross-Maier



VAD024518 18 cm / 7" VAD024618
 VAD024520 20 cm / 8" VAD024620
 Straight Curved



Gross-Maier

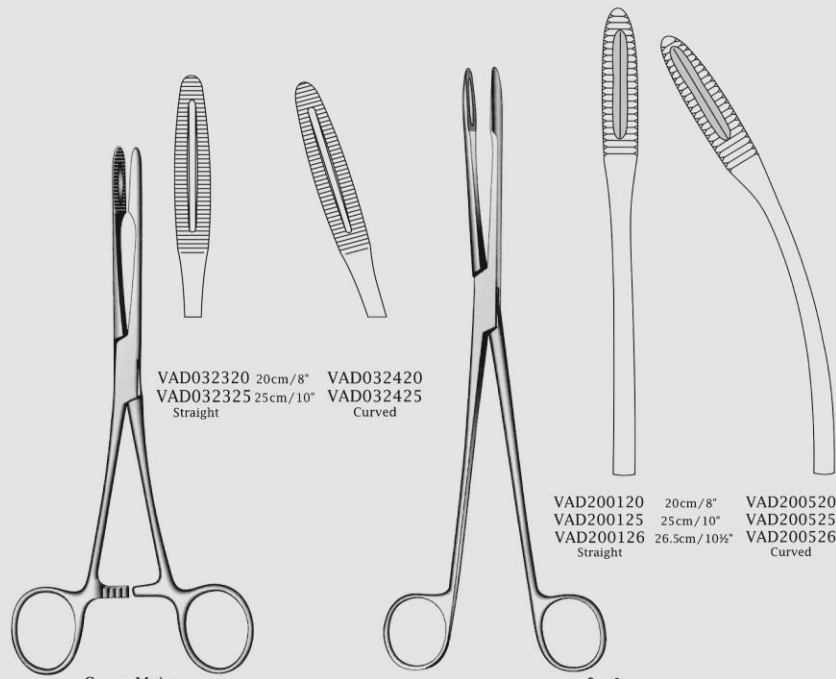


VAD024718 18 cm / 7" VAD024818
 VAD024720 20 cm / 8" VAD024820
 Straight Curved



Cotton Swab Forceps

Polypus, Dressing and Cotton Swab Forceps
Korn-(Polypen-)Zangen, Tupferzangen
Pinzas para polipos Y vendajes, Pinzas para tapones

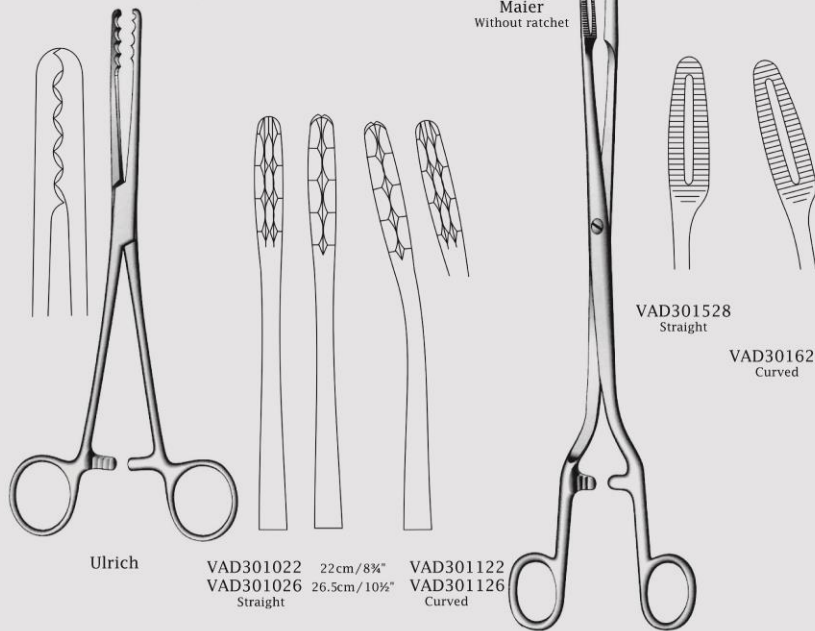


VAD032320 20cm/8" VAD032420
VAD032325 25cm/10" VAD032425
Straight Curved

VAD200120 20cm/8" VAD200520
VAD200125 25cm/10" VAD200525
VAD200126 26.5cm/10½" VAD200526
Straight Curved

Gross-Maier

Maier
Without ratchet



Ulrich

VAD301022 22cm/8¾" VAD301122
VAD301026 26.5cm/10½" VAD301126
Straight Curved

Sims-Maier
28 cm / 11"

پنس ها



CE

SQS Certificate
ISO 9001:2000
ISO 13485:2003

133



Cotton Swab Forceps
 Polypus, Dressing, Cotton Swab
 & Foreign Body Forceps
 Korn-Polypen-Zangen, Tupferzangen
 und Fremdkörperzangen
 Polopos, vendajes, Tapones Y
 Pinzas para cuerpos extraños

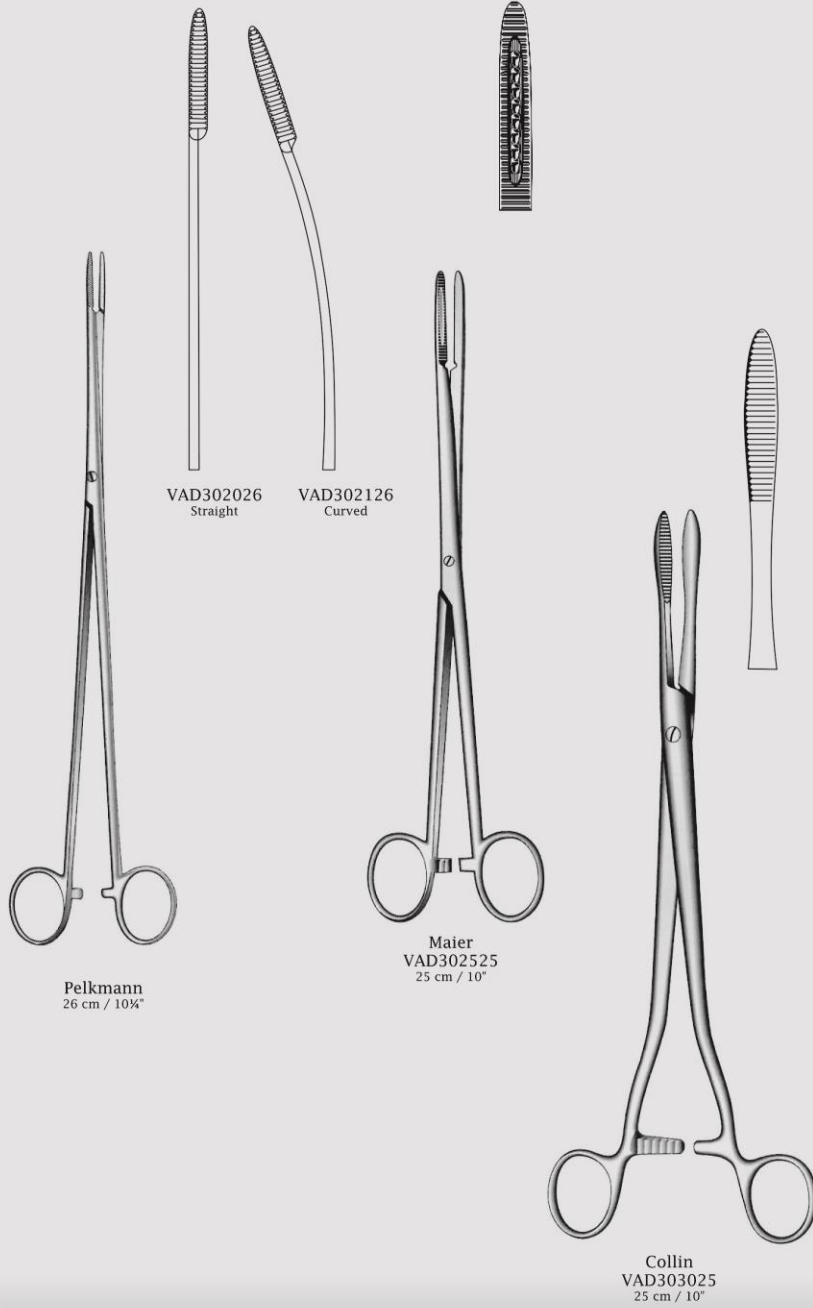
پنس ها



CE

SQS Certificate
 ISO 9001:2000
 ISO 13485:2003

134





Cotton Swab Forceps

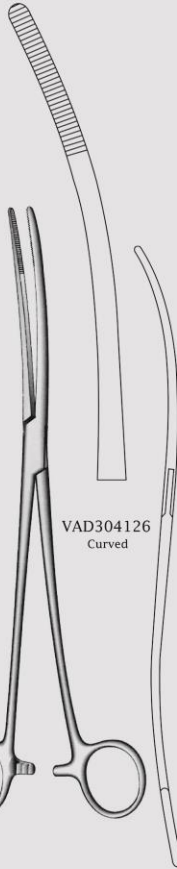
Derssing Forceps, Sponge Forceps
Kornzangen, Schwammzangen
Pinzas para vendajes, Pinzas para tapones



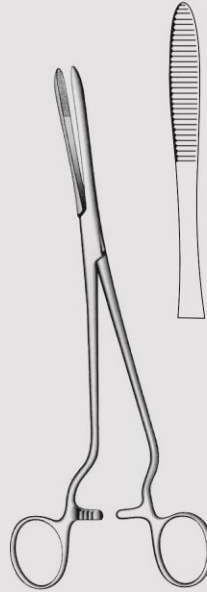
Cheron
VAD303525
25 cm / 10"



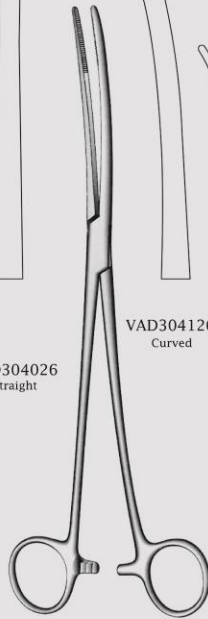
VAD304026
Straight



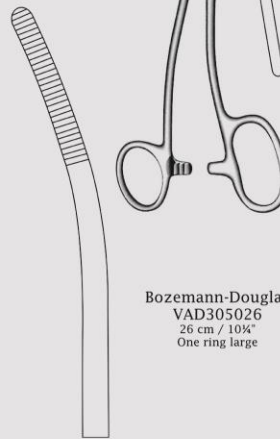
VAD304126
Curved



Cheron
VAD304524
24 cm / 9 1/2"
Handles laterally angled



Bozemann
26 cm / 10 1/4"



Bozemann-Douglas
VAD305026
26 cm / 10 1/4"
One ring large

پنس ها



CE

SQS Certificate
ISO 9001:2000
ISO 13485:2003

135



Cotton Swab Forceps
Sponge Forceps
Schwammzangen
Pinzas para tapones

پنس ها



CE

SQS Certificate
ISO 9001:2000
ISO 13485:2003

136

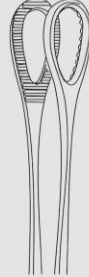


Foerster

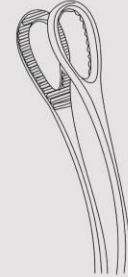
VAD305525
25 cm / 10"
Smooth jaws



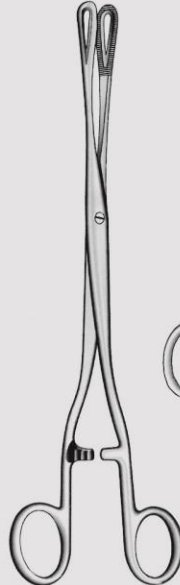
VAD305618 18cm / 7"
VAD305620 20 cm / 8"
VAD305625 25cm / 10"



VAD305725
25 cm / 10"
Smooth jaws



VAD305818 18 cm / 7"
VAD305820 20cm / 8"
VAD305824 25 cm / 10"

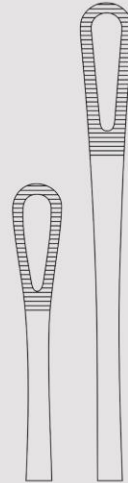


Rampley

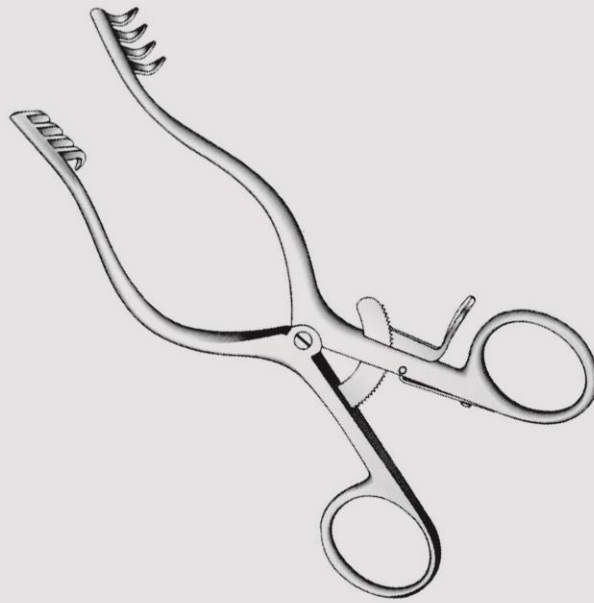
Rampley
VAD306018 18 cm / 7"
VAD306025 25 cm / 10"



VAD306518 18 cm / 7"
VAD306524 25 cm / 10"
Box lock
VAD306618 18 cm / 7"
VAD306624 25 cm / 10"
Screw lock



DIAMOND SURGICAL
WWW.DIAMONDMED.IR INSTRUMENTS



VAE

Retractors



CE

SQS Certificate
ISO 9001:2000
ISO 13485:2003

137



Retractors
Retractors
Wundhaken
Separadores

اکار تورها



CE

SQS Certificate
ISO 9001:2000
ISO 13485:2003

138

Fig. 2 30 x 10 mm
Fig. 1 26 x 10 mm



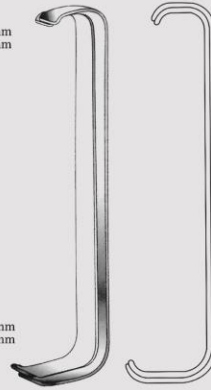
Farabeuf
VAE076400
12 cm / 4 3/4"
Set of 2

Fig. 2 27 x 16 mm
Fig. 1 23 x 16 mm



Farabeuf
VAE076600
15 cm / 6"
Set of 2

Fig. 2 21 x 14 mm
Fig. 1 17 x 14 mm

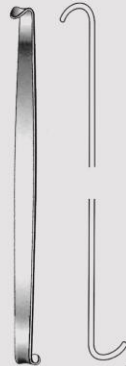


Collin
VAE300115
15 cm / 6"
Set of 2

Fig. 1 30 x 13 mm
Fig. 2 34 x 13 mm

Fig. 1 26 x 16 mm
Fig. 2 30 x 16 mm

Fig. 1 28 x 16 mm
Fig. 2 32 x 16 mm

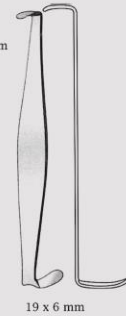


Mini-Roux
VAE076806
14 cm / 5 1/2"



Roux
VAE075600Set
VAE075601 14cm/5 1/2"
VAE075602 15cm/6"
VAE075603 17cm/6 3/4"
VAE075604 18cm/7"

11 x 4 mm



19 x 6 mm

Crile
VAE300511
11 cm / 4 3/4"

Fig. 2 22 x 15 mm
Fig. 1 19 x 15 mm



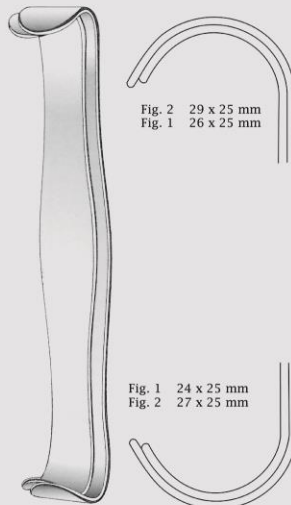
Fig. 1 19 x 15 mm
Fig. 2 22 x 15 mm

Baby-Roux
VAE077013
13 cm / 5 1/4"

Parker
VAE077401
Set of two



Retractors
Retractors
Wundhaken
Separadores



Parker
VAE077402
18 cm / 7"
Set of 2

Fig. 2 29 x 25 mm
Fig. 1 26 x 25 mm

Fig. 2 25 x 24 mm
Fig. 1 21 x 24 mm

Fig. 1 24 x 25 mm
Fig. 2 27 x 25 mm

Fig. 1 68 x 24 mm
Fig. 2 72 x 24 mm

Parker-Mott
VAE301016
16 cm / 6¼"
Set of 2



Fig. 2 25 x 24 mm
Fig. 1 21 x 24 mm

Fig. 1 40 x 15 mm
Fig. 2 45 x 15 mm



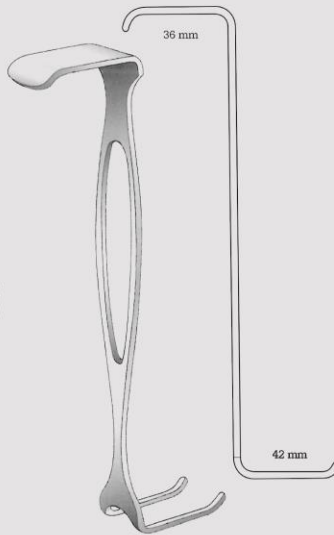
Parker-Langenbeck
VAE301521
21 cm / 8¼"
Set of 2

Fig. 2 47 x 13 mm
Fig. 1 41 x 13 mm

Fig. 1 37 x 25 mm
Fig. 2 42 x 25 mm



Mathieu
VAE302020
20 cm / 8"



Czerny
VAE302517
17.5 cm / 7"



Canny Ryoll
VAE303016 16cm/6¼"
VAE303020 20cm/8"
VAE303025 25cm/10"
VAE303030 30cm/12"

اکار تورها



CE

SQS Certificate
ISO 9001:2000
ISO 13485:2003

139



Retractors
Retractors
Wundhaken
Separadores

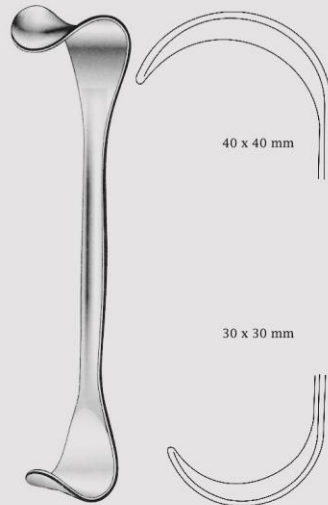
اکار تورها



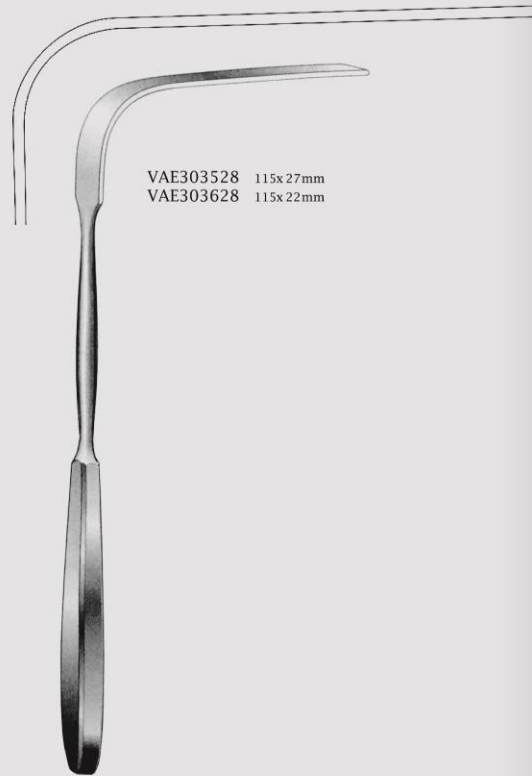
CE

SQS Certificate
ISO 9001:2000
ISO 13485:2003

140



Goelet
VAE079600
19 cm / 7½"

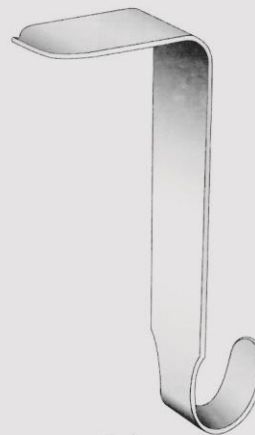


VAE303528 115x 27mm
VAE303628 115x 22mm

Simon
28 cm / 11"



Hibbs
VAE304022
22 cm / 8¾"
25 x 75 mm blade



Taylor
VAE304518 18cm/7", 75x 30mmblade
VAE304520 20cm/8", 100x 30mmblade
Spinal retractor



Retractors
Retractors
Wundhaken
Separadores



Deaver
VAE305018
18 cm / 7"
19 mm

Deaver
VAE305521
21.5 cm / 8½"
22 mm

Deaver
VAE306023
23 cm / 9"
25 mm

Deaver
VAE306530
30 cm / 12"
25 mm

Deaver
VAE307033
33 cm / 13"
25 mm

Deaver
VAE307536
36 cm / 14"
25 mm

اکار تورها
دیورها



CE

SQS Certificate
ISO 9001:2000
ISO 13485:2003

141



Retractors
Retractors
Wundhaken
Separadores

اکار تورها
دیورها



CE

SQS Certificate
ISO 9001:2000
ISO 13485:2003

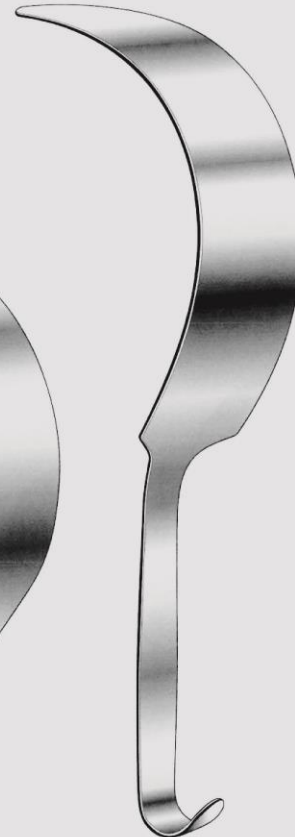
142



Deaver
VAE308030
30 cm / 12"
38 mm



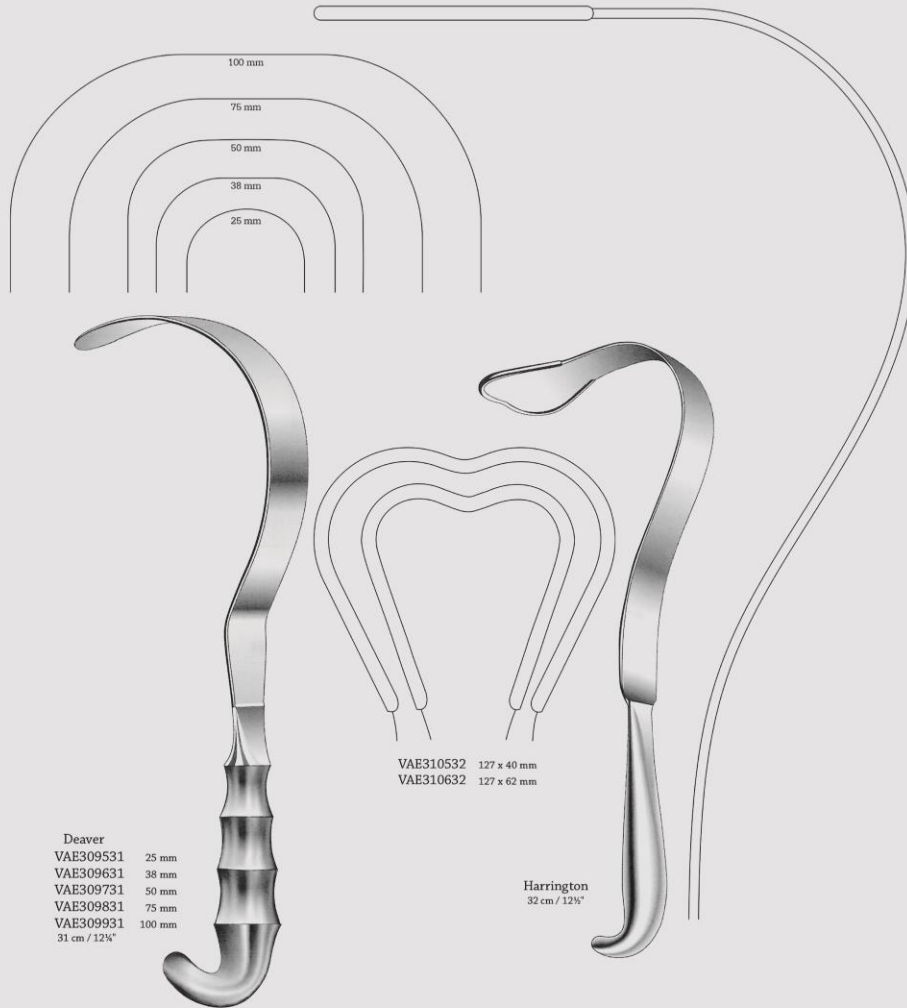
Deaver
VAE308530
30 cm / 12"
50 mm



Deaver
VAE309030
30 cm / 12"
75 mm



Retractors
Retractors
Wundhaken
Separadores



Deaver
VAE309531 25 mm
VAE309631 38 mm
VAE309731 50 mm
VAE309831 75 mm
VAE309931 100 mm
31 cm / 12 1/4"

VAE310532 127 x 40 mm
VAE310632 127 x 62 mm

Harrington
32 cm / 12 5/8"

اکار تورها



CE

SQS Certificate
ISO 9001:2000
ISO 13485:2003

143



Retractors
Hooklets
Wundhaken
Ganchitos

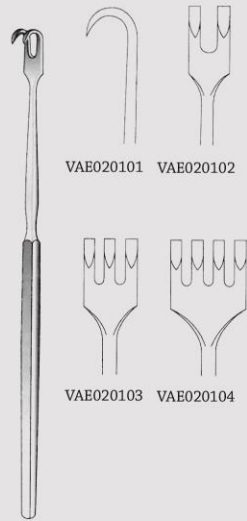
اکار توراها
هوک ها



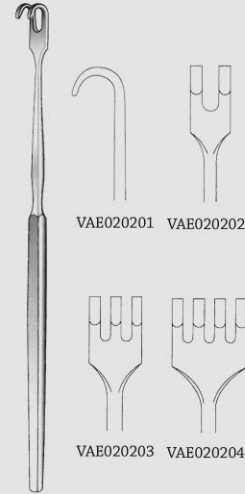
CE

SQS Certificate
ISO 9001:2000
ISO 13485:2003

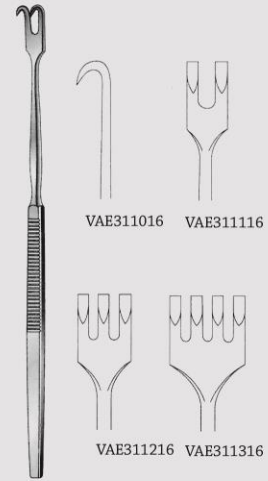
144



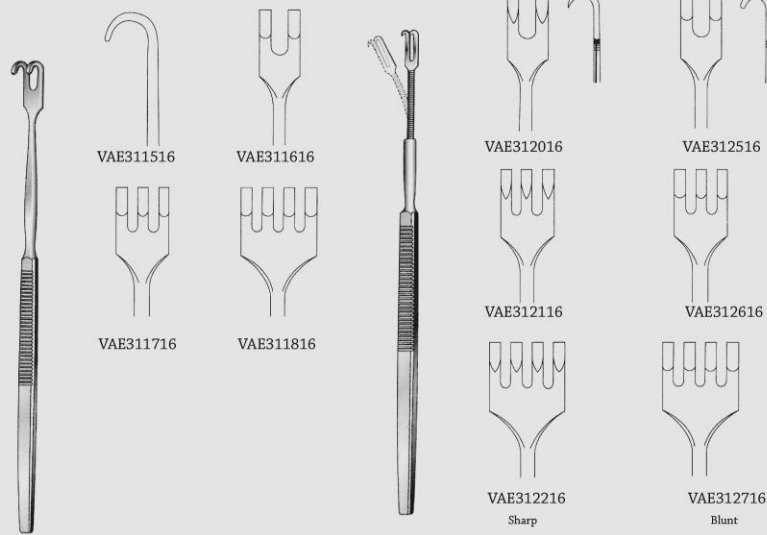
16 cm / 6 1/4"
Sharp



16 cm / 6 1/4"
Blunt



16 cm / 6 1/4"
Sharp



16 cm / 6 1/4"
Blunt

16 cm / 6 1/4"
Flexible



Retractors

Micro Hooklets, Skin Hooks
Mikrohakchen, Hauthakchen
Micro Ganchitos, Ganchitos de piel



16 cm / 6 1/4"
Sharp



VAE313016
Fig. 1



VAE313116
Fig. 2



VAE313216
Fig. 3



VAE313316
Fig. 4



Graefe
16 cm / 6 1/4"



VAE313516
Sharp



VAE313616
Blunt



O'Connor
VAE314016
16 cm / 6 1/4"
Sharp



Guthrie
16 cm / 6 1/4"
Sharp



VAE314516
1.5 mm



VAE314616
2 mm



CE

SQS Certificate
ISO 9001:2000
ISO 13485:2003

145



Retractors
Saddle Hooks, Hooklets
Sattelhakchen,
Wundhakchen
Ganchos en forma
de silla, Ganchitos

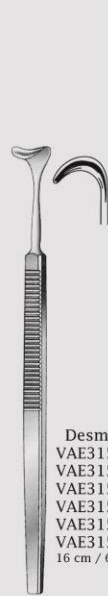
اکار تورها



CE

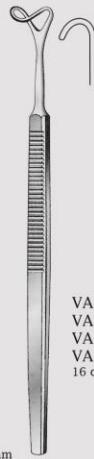
SQS Certificate
ISO 9001:2000
ISO 13485:2003

146



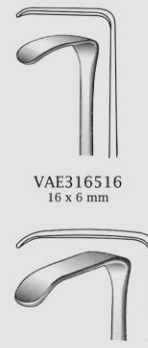
Desmarres

VAE315016 8 mm
VAE315116 10mm
VAE315216 12mm
VAE315316 14mm
VAE315416 16mm
VAE315516 18mm
16 cm / 6 1/4"



Langenbeck-Green
16 cm / 6 1/4"

VAE316016 12mm
VAE316116 14mm
VAE316216 16mm
VAE316316 18mm
16 cm / 6 1/4"



VAE316616
24 x 6 mm



Mini-Langenbeck
VAE317016 10x6 mm
VAE317116 17x5 mm
VAE317216 20x6 mm
VAE317316 22x8 mm
16 cm / 6 1/4"



Cushing
20 cm / 8"

VAE317520
8 mm

VAE317620
12 mm

VAE317720
16 mm



VAE318020
10 mm



VAE318120
14 mm



VAE318220
18 mm



Cushing
24 cm / 9 1/2"

VAE318524
8 mm

VAE318624
12 mm

VAE318724
16 mm

VAE319024
10 mm

VAE319124
14 mm

VAE319224
18 mm



Retractors
Hooklets
Wundhakchen
Ganchitos



اکار تورها



CE

SQS Certificate
ISO 9001:2000
ISO 13485:2003

147



Retractors
Retractors
Wundhaken
Separadores

اکار تورها



CE

SQS Certificate
ISO 9001:2000
ISO 13485:2003

148



VAE032101



VAE032102



VAE032103



VAE032104



VAE032106



Sharp



VAE032201



VAE032202



VAE032203



VAE032204



VAE032206



Blunt



Volkmann
21.5 cm / 8 1/2"



Volkmann
23 cm / 9"



Sharp



VAE321523



VAE321623



VAE321723



VAE321823



VAE321923



Blunt



VAE322523



VAE322623



VAE322723



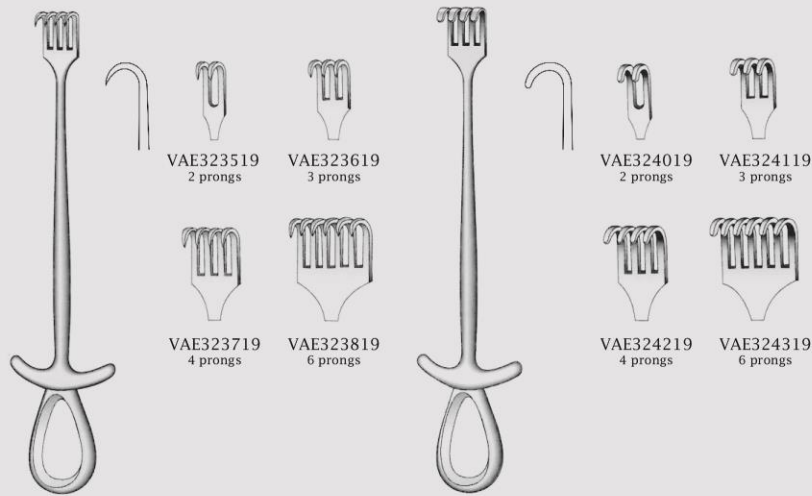
VAE322823



VAE322923



Retractors
Retractors
Wundhaken
Separadores



Murphy
19 cm / 7½"
Sharp

Murphy
19 cm / 7½"
Blunt



Kocher
22 cm / 8¼"

VAE323519
2 prongs

VAE323619
3 prongs

VAE324019
2 prongs

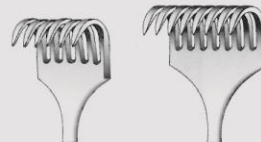
VAE324119
3 prongs

VAE323719
4 prongs

VAE323819
6 prongs

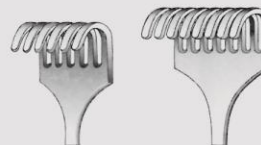
VAE324219
4 prongs

VAE324319
6 prongs



VAE324922

VAE325022



VAE325922

VAE326022



Sharp



VAE324522



VAE324622



VAE324722



VAE324822



Blunt



VAE325522



VAE325622



VAE325722



VAE325822

اکار توها



CE

SQS Certificate
ISO 9001:2000
ISO 13485:2003

149



Retractors
Retractors
Wundhaken
Separadores

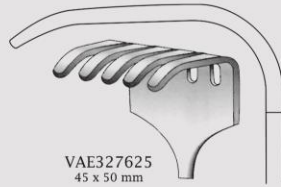
اکار تورها



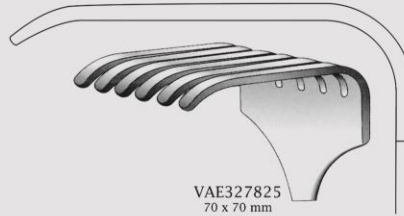
CE

SQS Certificate
ISO 9001:2000
ISO 13485:2003

150



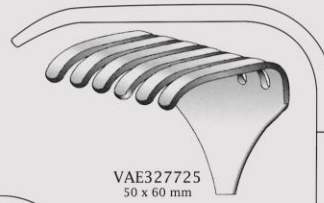
VAE327625
45 x 50 mm



VAE327825
70 x 70 mm



VAE327525
40 x 40 mm



VAE327725
50 x 60 mm



VAE326500
40 x 30 mm
Sharp



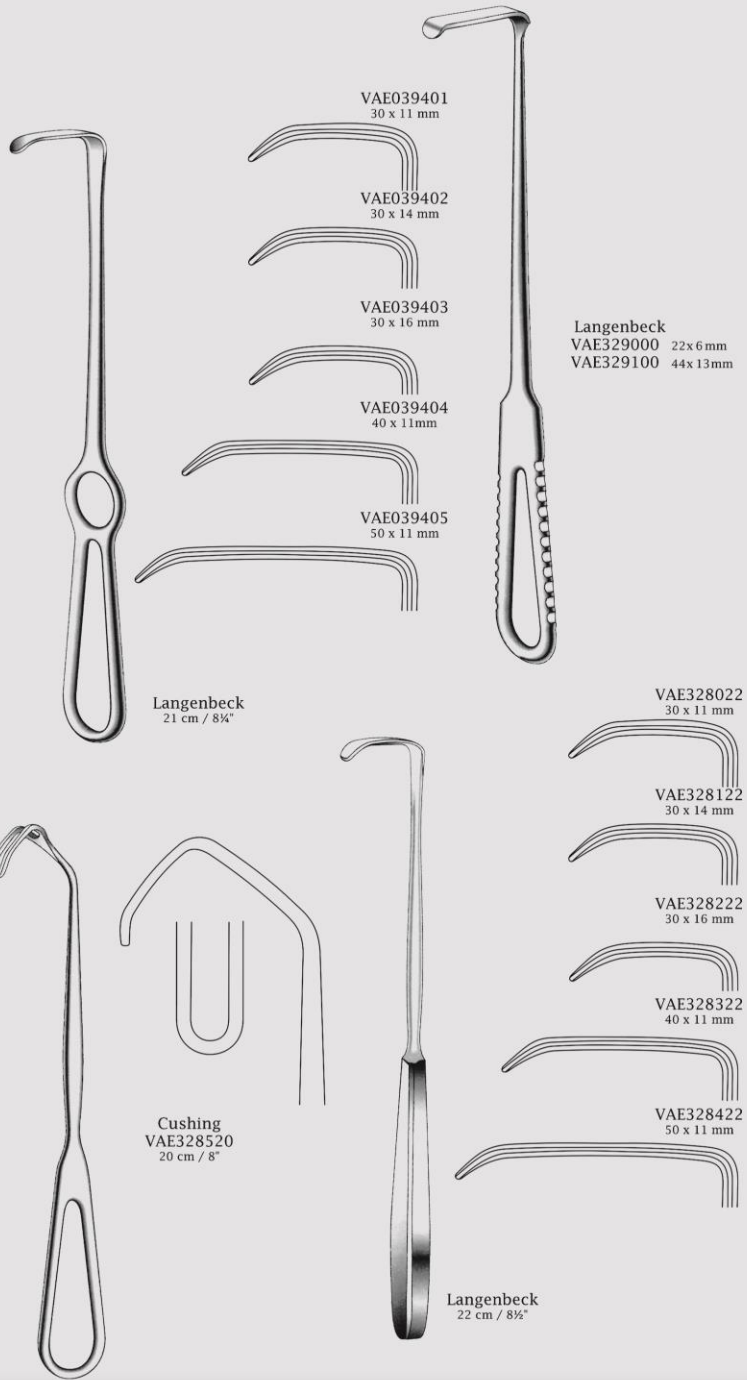
Koerte
VAE327023
23.5 cm / 9 3/4"
40 x 30 mm
blunt



Israel
25 cm / 10"



Retractors
Retractors
Wundhaken
Separadores



اکار تورها



CE

SQS Certificate
ISO 9001:2000
ISO 13485:2003

151



Retractors
Retractors
Wundhaken
Separadores

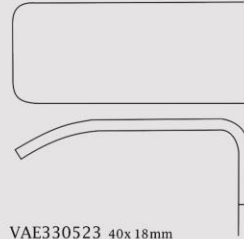
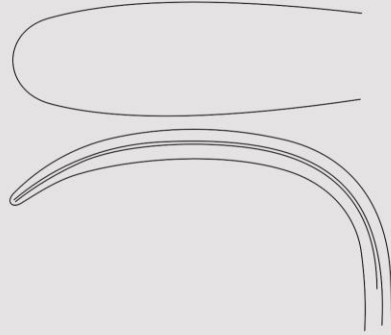
اکار تورها



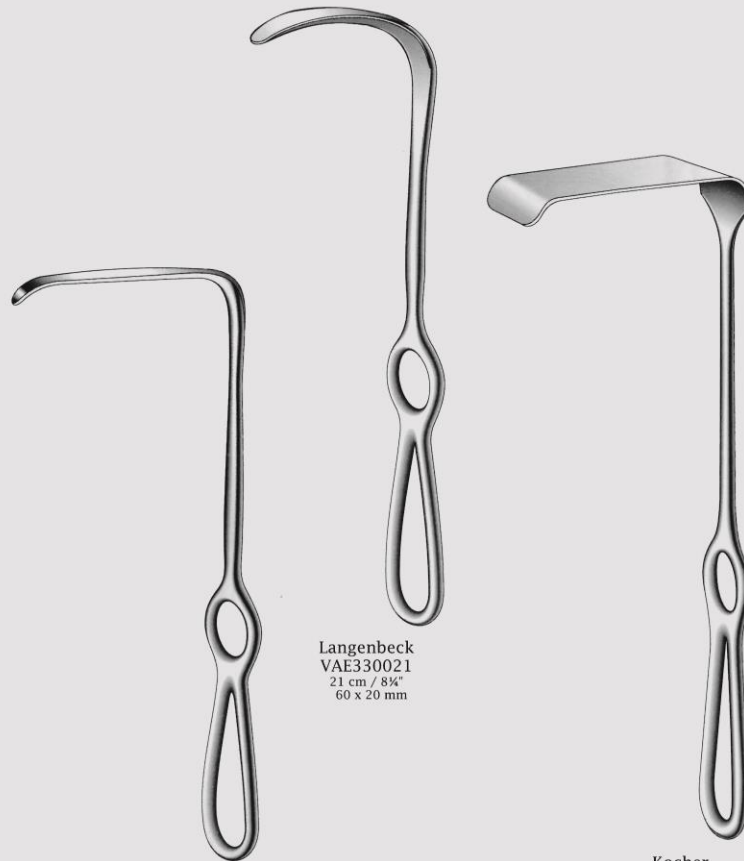
CE

SQS Certificate
ISO 9001:2000
ISO 13485:2003

152



VAE330523 40x 18mm
VAE330623 60x 20mm
VAE330723 60x 25mm
VAE330823 75x30mm
VAE330923 75x 40mm



Langenbeck
VAE330021
21 cm / 8 1/4"
60 x 20 mm

Langenbeck
VAE329521
21 cm / 8 1/4"
85 x 15 mm

Kocher
23 cm / 9"



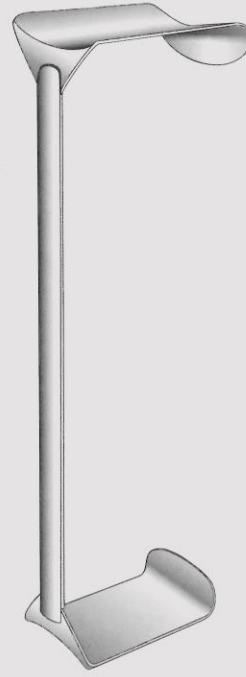
Retractors
Retractors
Wundhaken
Separadores



- VAE041801 25 x 6 mm
- VAE041802 38 x 8 mm
- VAE041803 35 x 11 mm
- VAE041804 35 x 15 mm
- VAE041805 40 x 11 mm
- VAE041806 55 x 11 mm
- VAE041807 70 x 14 mm
- VAE041808 80 x 12 mm
- VAE041809 80 x 16 mm

Kocher-Langenbeck
21.5 cm / 8 1/2"

- Morris**
- VAE331500 40 mm
 - VAE331600 50 mm
 - VAE331700 65 mm



- Morris**
- VAE332000 30 x 40 mm
 - VAE332100 45 x 50 mm
 - VAE332200 55 x 60 mm

اکار تورها



SQS Certificate
ISO 9001:2000
ISO 13485:2003





Retractors
Retractors
Wundhaken
Separadores

اکار تورها



CE

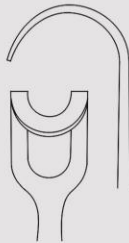
SQS Certificate
ISO 9001:2000
ISO 13485:2003

154



Ollier
VAE333022
22.5 cm / 9"
36 x 60 mm

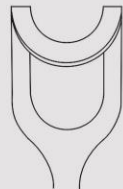
Ollier
VAE332522
22.5 cm / 9"
36 x 30 mm



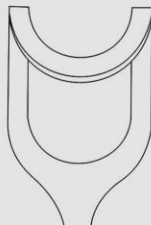
VAE046201
21.5 cm / 8 1/2"
14 x 17 mm



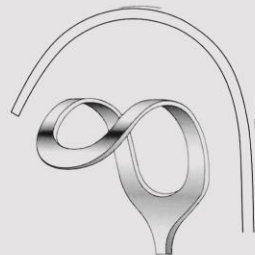
Middeldorpf



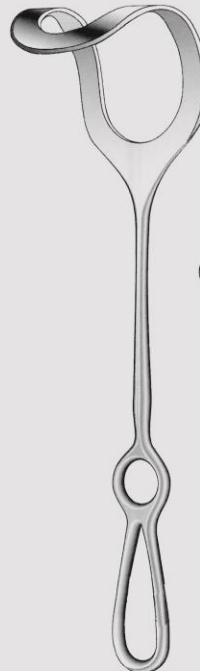
VAE046202
22 cm / 8 3/4"
20 x 22 mm



VAE046203
23.5 cm / 9 1/4"
26 x 30 mm



VAE333525
45 x 45 mm



VAE333625
45 x 50 mm

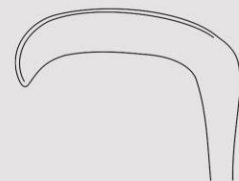


VAE333725
55 x 70 mm

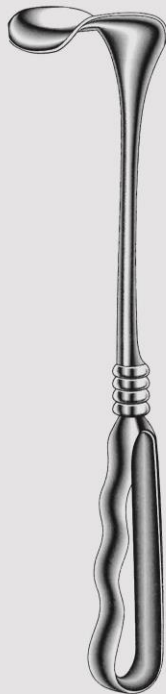
Middeldorpf
25.5 cm / 10"



Retractors
Retractors
Wundhaken
Separadores



VAE33402428x20mm
VAE33412436x28mm
VAE33422444x38mm



Richardson
24 cm / 9½"



Richardson
VAE334524
24 cm / 9½"
52 x 22 mm



Kelly
VAE335026 50x35mm
VAE335126 65x50mm
VAE335226 75x65mm
26 cm / 10¼"

Fig. 2 49 x 38 mm
Fig. 1 28 x 20 mm

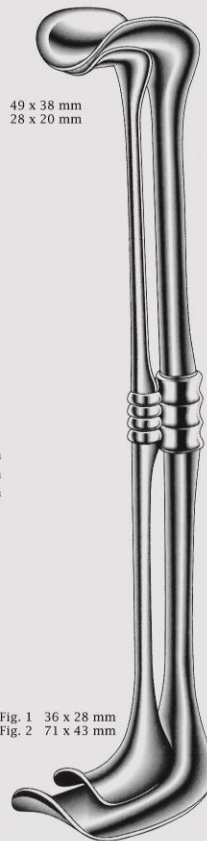


Fig. 1 36 x 28 mm
Fig. 2 71 x 43 mm

Richardson-Eastman
VAE335526 26cm/10¼" Fig.1
VAE335528 28cm/11" Fig.2
VAE335530Set of 2, Fig.1 & Fig.2

اکار تورها
ریچار دسون



CE

SQS Certificate
ISO 9001:2000
ISO 13485:2003

155



Retractors
Retractors
Wundhaken
Separadores

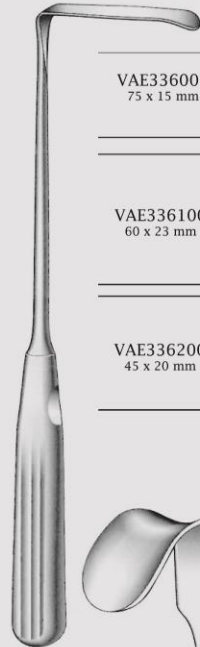
اکار تورها



CE

SQS Certificate
ISO 9001:2000
ISO 13485:2003

156



Saurbruch

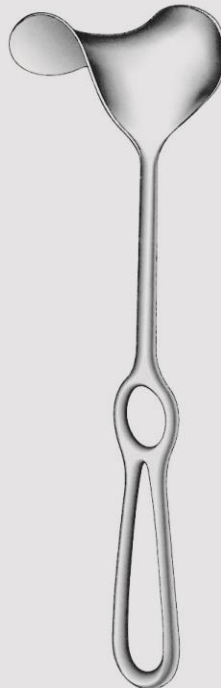
VAE336000
75 x 15 mm

VAE336100
60 x 23 mm

VAE336200
45 x 20 mm



Fritsch
VAE336524
24 cm / 9 1/2"
40 x 40 mm



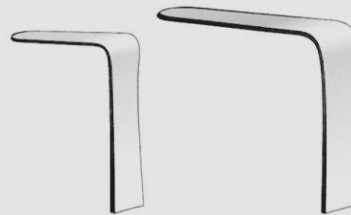
Fritsch
VAE337024 45x 40mm
VAE337124 45x 50mm
VAE337224 45x 60mm
VAE337324 45x 75mm
24 cm / 9 1/2"



Doyen
VAE337525
25 cm / 10"
50 x 85 mm



Retractors
Retractors
Wundhaken
Separadores



VAE339127
45 x 25 mm

VAE339227
73 x 28 mm



Tuffier
VAE338023
23 cm / 9"

Koerte
VAE338528
28 cm / 11"
120 x 47 mm
Rigid

Heaney
VAE339027
82 x 28 mm
27 cm / 10 3/4"

اکار تورها



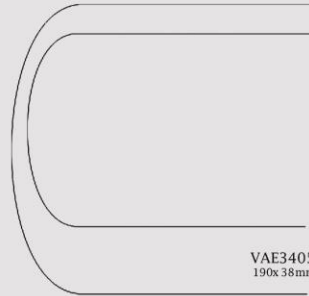
CE

SQS Certificate
ISO 9001:2000
ISO 13485:2003

157

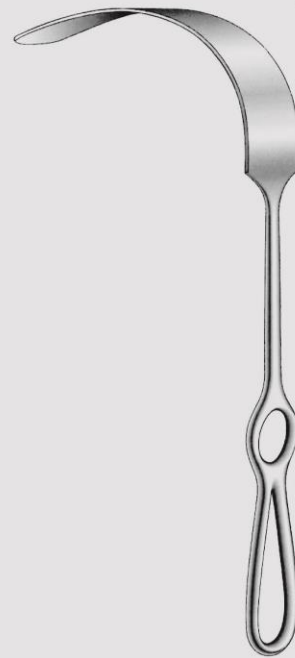
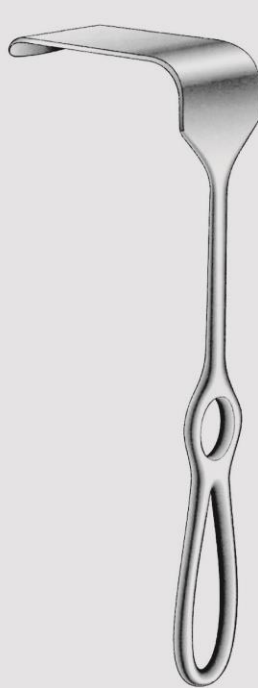


Retractors
Retractors
Wundhaken
Separadores



VAE340527
190x38mm

VAE340627
190x57mm



Mikulicz
VAE339526
26 cm / 10 1/4"
90 x 50 mm

Mikulicz
VAE340026 95x35mm
VAE340126 120x50mm
VAE340226 150x50mm
26 cm / 10 1/4"

Kelly
27 cm / 10 1/2"



SQS Certificate
ISO 9001:2000
ISO 13485:2003

158



Retractors
Retractors
Wundhaken
Separadores

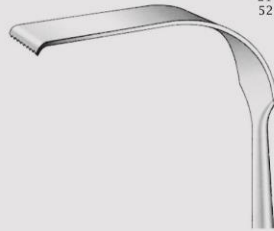


Meyering
For deep surgery

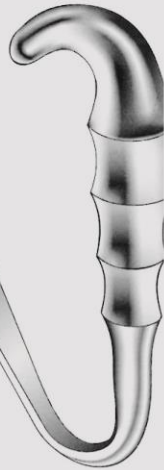
VAE341025
25.5 cm / 10"
89 x 50 mm



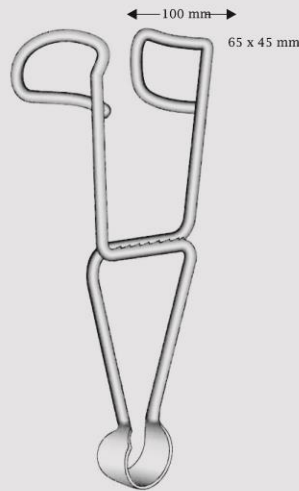
VAE341021
21 cm / 8 3/4"
52 x 16 mm



VAE341023
23 cm / 9"
76 x 25 mm



Davidson
VAE341516
VAE341616
16 cm / 6 3/4"
Scapula retractor



Dartigues
VAE342000

اکار تورها



SQS Certificate
ISO 9001:2000
ISO 13485:2003

159



Retractors
Pelvis Retractors
Beckenhaken
Separadores para pelvis

اکار تورها



CE

SQS Certificate
ISO 9001:2000
ISO 13485:2003

160



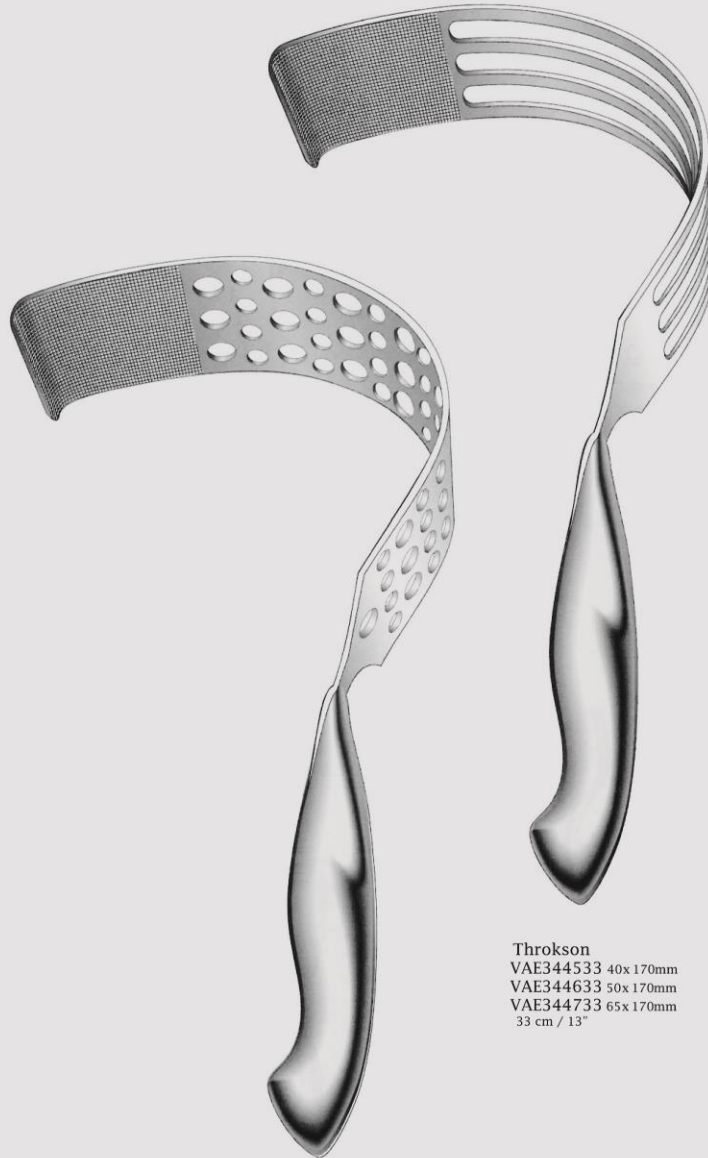
St-Marks
VAE342529
29 cm / 11½"

St-Marks
VAE343032
32.5 cm / 13"

St-Marks
VAE343532
32.5 cm / 13"



Retractors
Retractors
Wundhaken
Separadores



Throkson
VAE344533 40x170mm
VAE344633 50x170mm
VAE344733 65x170mm
33 cm / 13"

Throkson
VAE344033 40x170mm
VAE344133 50x170mm
VAE344233 65x170mm
33 cm / 13"

اکار تورها



CE

SQS Certificate
ISO 9001:2000
ISO 13485:2003

161



Retractors

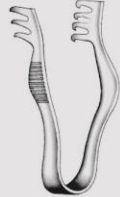
Wound Spreaders,
Self-retaining
Wundspreizer
Separadores autoestaticos

اکار تورها

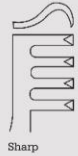


SQS Certificate
ISO 9001:2000
ISO 13485:2003

162



Finsen
VAE345007
VAE345507
7 cm / 2¾"



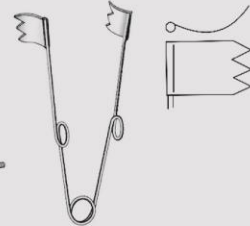
Sharp



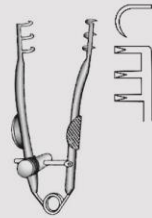
Blunt



Finsen
VAE345107
VAE345607
7 cm / 2¾"
With adjusting screw



VAE346008
8 cm / 3¼"



Buckley
VAE346506
6 cm / 2½"



Alm



VAE347007 7 cm / 2¾"
VAE347010 10 cm / 4"
Sharp
VAE347107 7 cm / 2¾"
VAE347110 10 cm / 4"
Blunt



VAE347510
Sharp



VAE347600
Blunt

10 cm / 4"



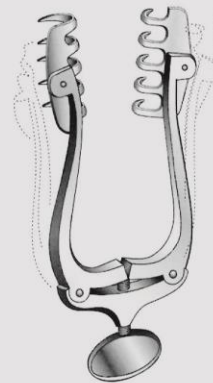
Jansen
10 cm / 4"



VAE348010
Sharp



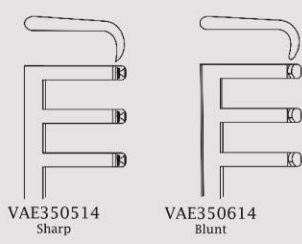
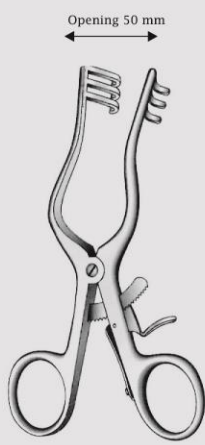
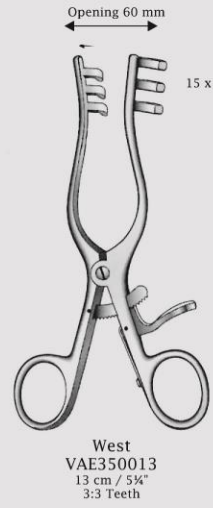
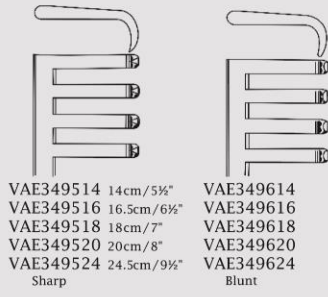
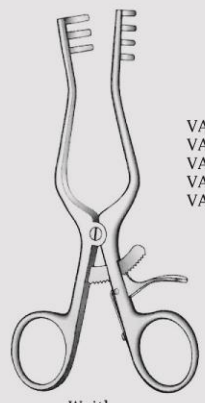
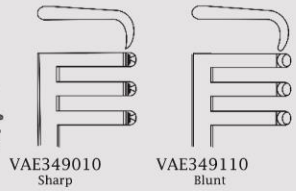
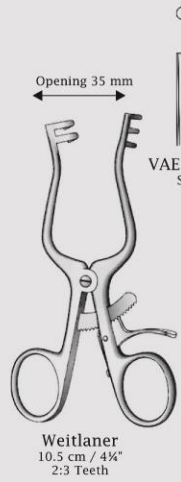
VAE348110
Blunt



Jansen-Wagner
VAE348510
10 cm / 4"



Retractors
Retractors
Wundhaken
Separadores



اکار تورها



CE

SQS Certificate
ISO 9001:2000
ISO 13485:2003

163



Retractors

Wound Spreaders, Self-retaining
Wundspreizer
Separadores autoestaticos

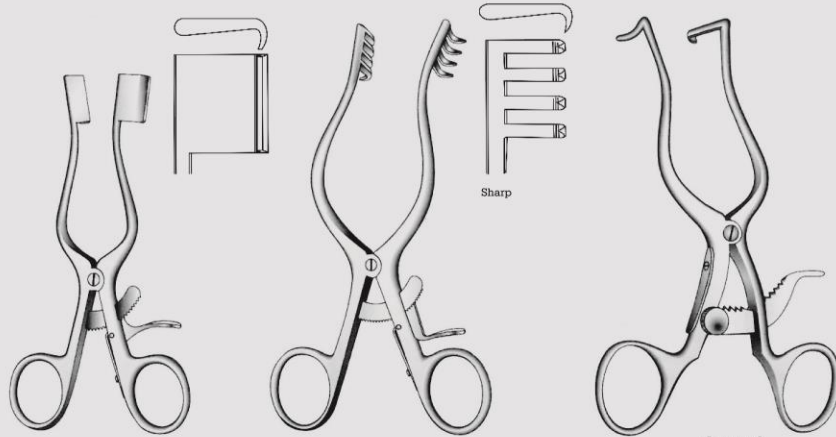
اکار تورها



CE

SQS Certificate
ISO 9001:2000
ISO 13485:2003

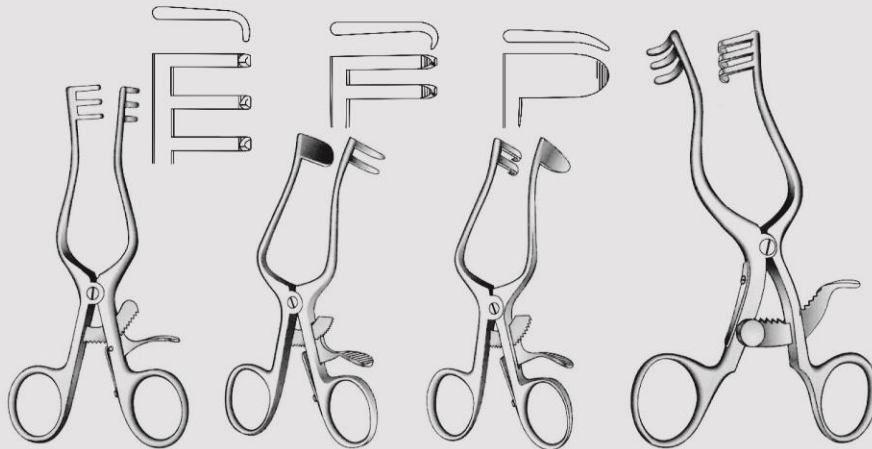
164



Weitlania
VAE351014
14 cm / 5 1/2"

Mollison
VAE351515
15 cm / 6"
4:4 Teeth

Cloward
VAE352013
13.5 cm / 5 1/4"
Blunt

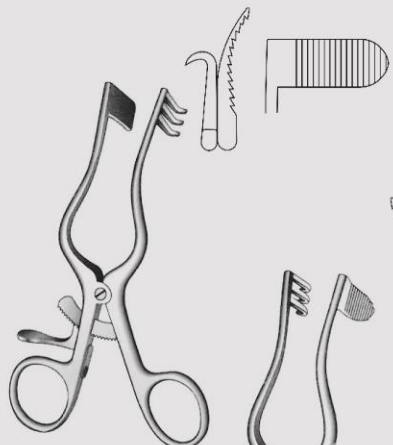


Milligan
VAE352513
13 cm / 5"
Blunt

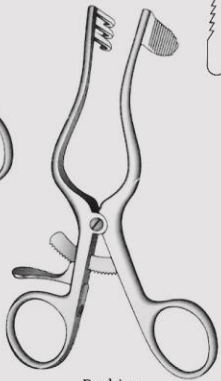
Plester
VAE353011
11 cm / 4 1/4"
Blunt
2 Teeth

Plester
VAE353511
11 cm / 4 1/4"
Blunt
2 Teeth

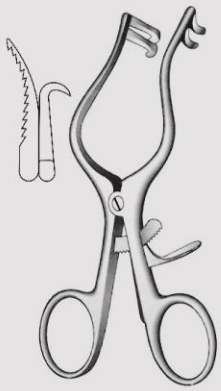
Cloward
VAE354013
13.5 cm / 5 1/4"
Blunt



Perkins
VAE354513
13 cm / 5"



Perkins
VAE355013
13 cm / 5"



Plester
VAE356014
14 cm / 5 1/2"
Blunt



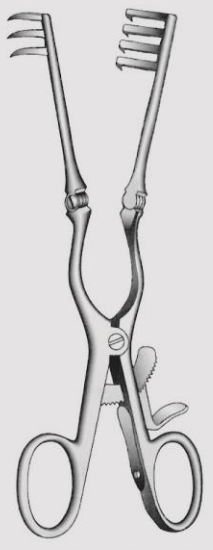
Norfolk-Norwich
VAE356522
22 cm / 8 3/4"
Blunt



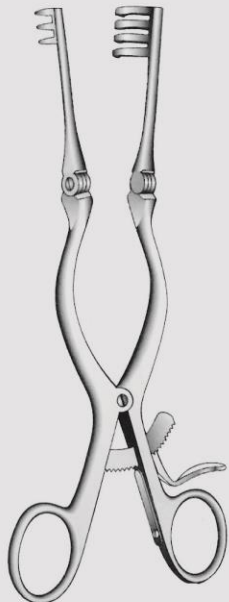
Travers
VAE357020
20 cm / 8"



Adson-Baby / Cone
VAE357513 VAE357613
13 cm / 5 1/4" 13 cm / 5 1/4"
Sharp Blunt



Adson-Baby / Cone
VAE358016 VAE358116
16 cm / 6 1/4" 16 cm / 6 1/4"
Sharp Blunt



Adson / Cone
VAE358520
20 cm / 8"
Sharp



Retractors
Retractors
Wundhaken
Separadores

اکار تورها



CE

SQS Certificate
ISO 9001:2000
ISO 13485:2003

165



Retractors

Wound Spreaders,
Self-retaining
Wundspreizer
Separadores autoestaticos

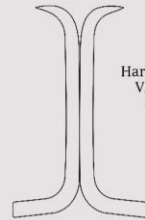
اکار تورها



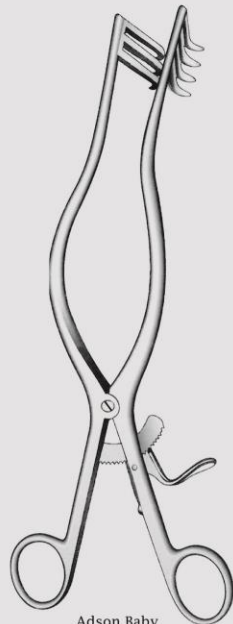
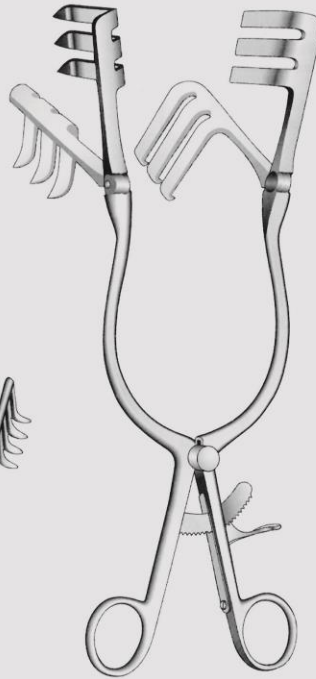
CE

SQS Certificate
ISO 9001:2000
ISO 13485:2003

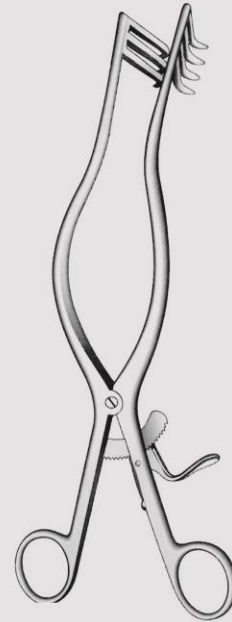
166



Harvey Jackson
VAE361028
28 cm / 11"
Sharp



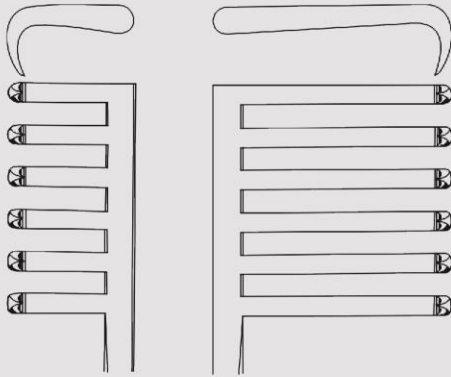
Adson Baby
VAE360014 14cm / 5 1/2" VAE360514
VAE360016 16cm / 6 1/4" VAE360516
VAE360020 20cm / 8" VAE360520
3:4 Teeth Blunt
Sharp



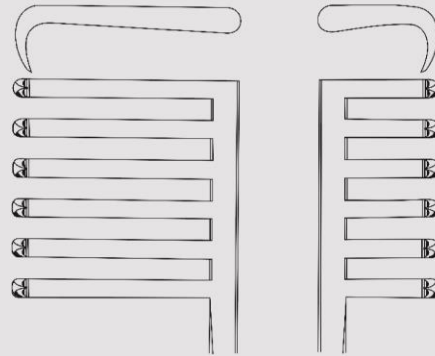
Adson
VAE359026 3x4 VAE359526
VAE359126 4x4 VAE359626
VAE359226 6x6 VAE359726
26.5 cm / 10 1/2" 26.5 cm / 10 1/2"
Sharp Blunt



Retractors
Retractors
Wundhaken
Separadores



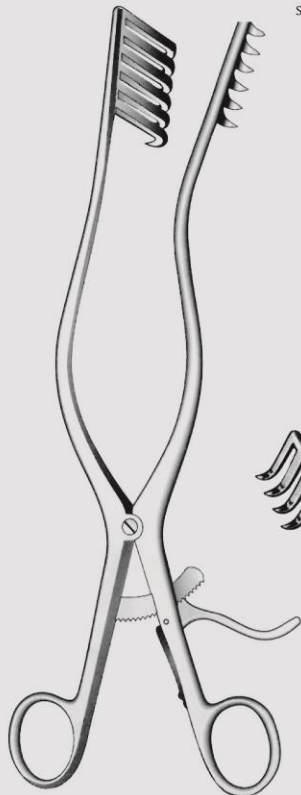
VAE362627
6:6 Teeth
Sharp, long teeth on Right side



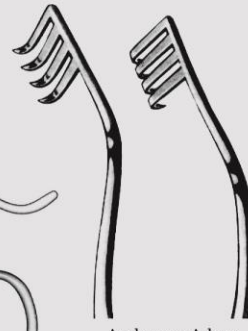
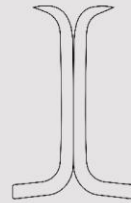
VAE362527
6:6 Teeth
Sharp, long teeth on left side



Adson
VAE361519 Sharp
19 cm / 7½"
VAE361520 Blunt
20 cm / 8"



Hemi-laminectomy retractor



Anderson-Adson
VAE362019
19.5 cm / 7¾"
Sharp

اکارتورها



CE

SQS Certificate
ISO 9001:2000
ISO 13485:2003

167



Retractors
Wound Spreaders, Self-retaining
Wundspreizer
Separadores autoestaticos

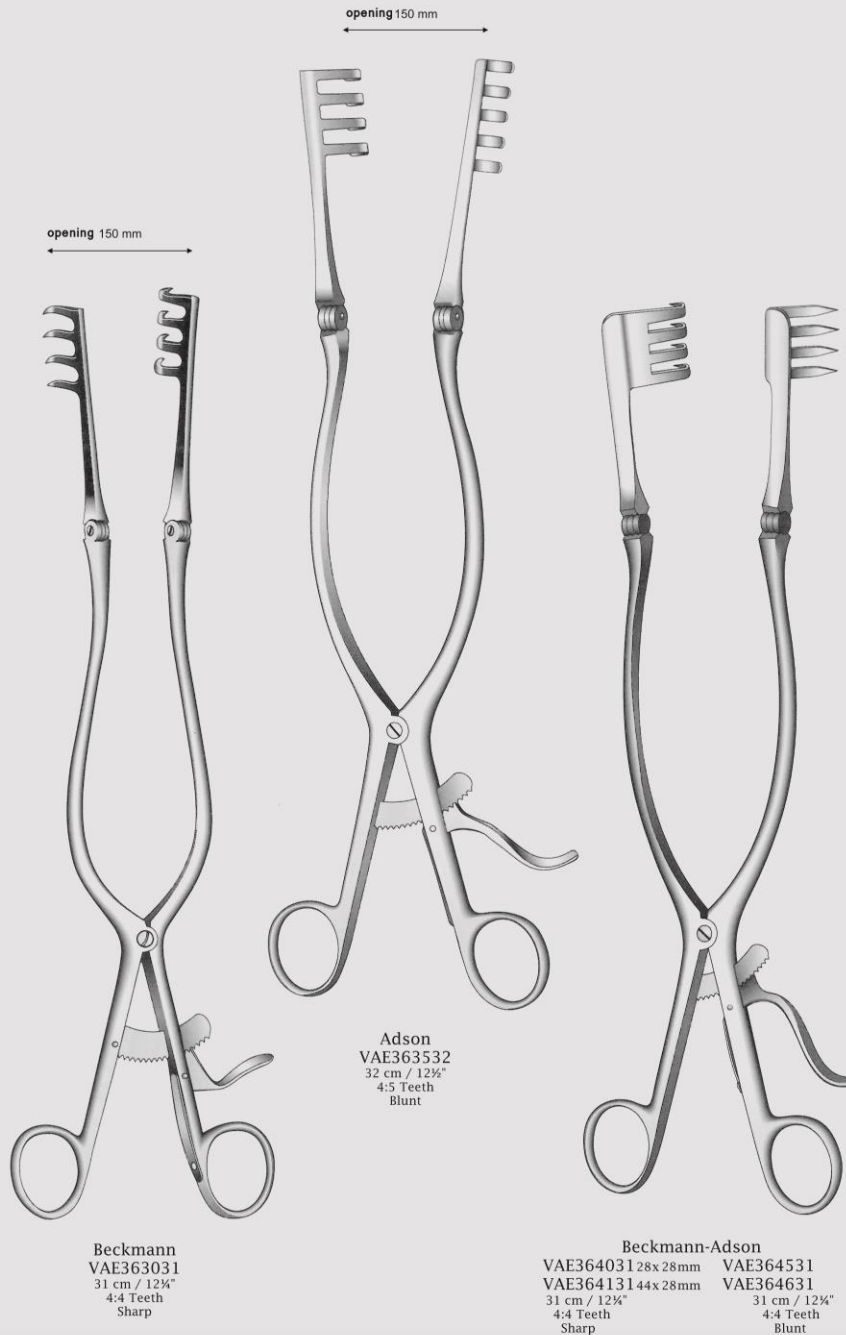
اکار تورها



CE

SQS Certificate
ISO 9001:2000
ISO 13485:2003

168

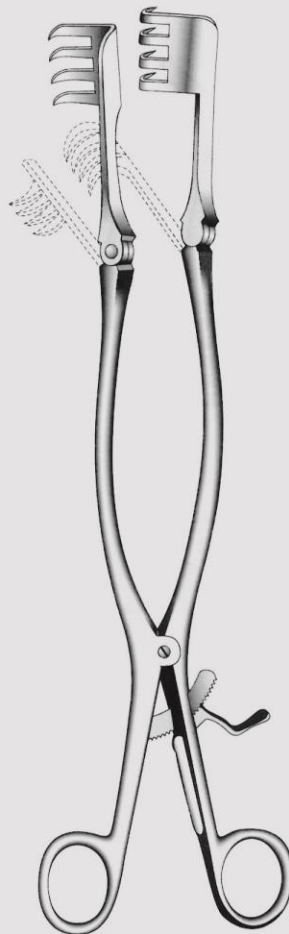
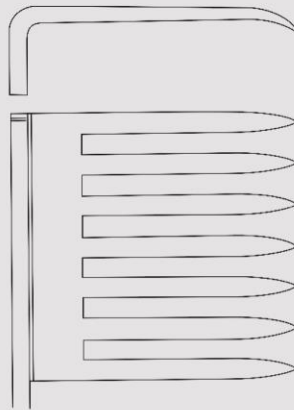




Retractors
Wound Spreaders,
Self-retaining
Wundspreizer
Separadores autoestaticos



Beckmann-Eaton
VAE365032
32 cm / 12½"



Beckmann
VAE365531
31 cm / 12½"

اکار تورها



CE

SQS Certificate
ISO 9001:2000
ISO 13485:2003

169



Retractors
Retractors
Wundhaken
Separadores

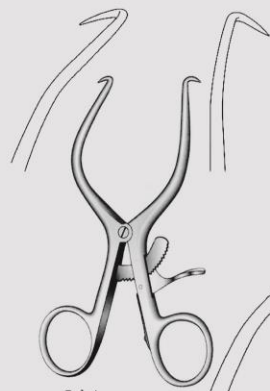
اکار تورها



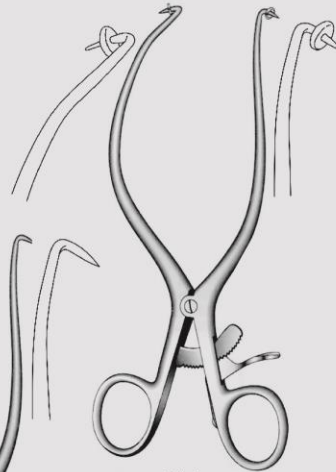
CE

SQS Certificate
ISO 9001:2000
ISO 13485:2003

170

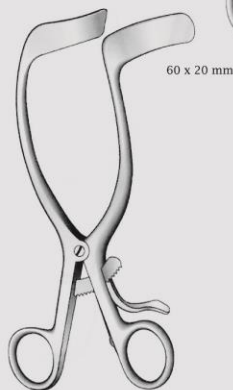


Gelpi
VAE366009 9cm / 3½"
VAE366011 11.5cm / 4½"
VAE366014 14cm / 5½"
VAE366016 16cm / 6¼"
VAE366018 18cm / 7"
VAE366020 20cm / 8"



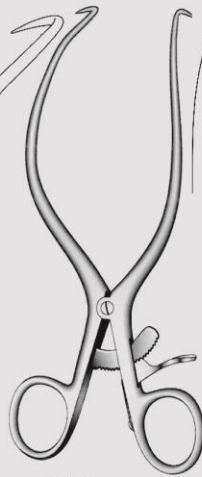
Gelpi
VAE367018
18 cm / 7"

Opening 100 mm



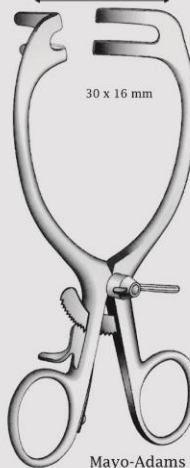
Rigby
VAE367518

60 x 20 mm



Gelpi
VAE366509 9cm / 3½"
VAE366511 11.5cm / 4½"
VAE366514 14cm / 5½"
VAE366516 16cm / 6¼"
VAE366518 18cm / 7"

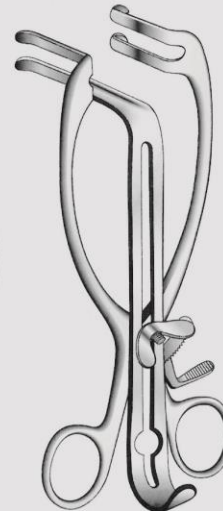
Opening 75 mm



Mayo-Adams
VAE368017

30 x 16 mm

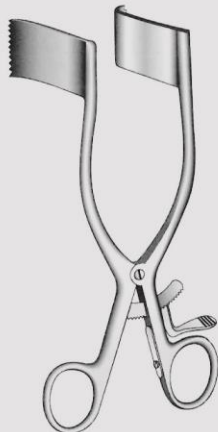
36 x 10 mm



Mayo-Adams
VAE368517
17 cm / 6¾"
With center blade



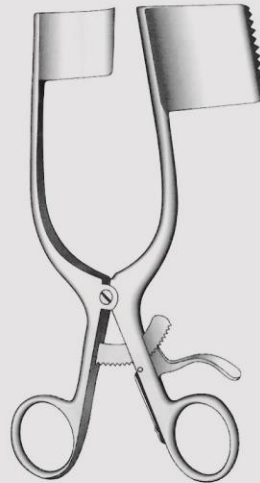
Retractors
Retractors
Wundhaken
Separadores



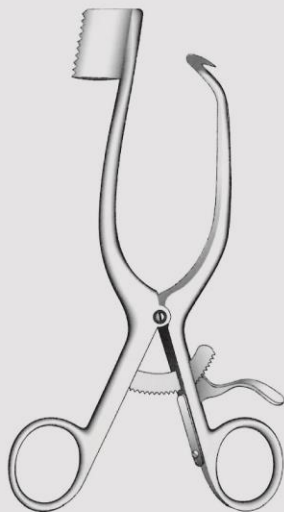
Meyerding
VAE369000 25 x 60 mm blade
VAE369100 25 x 55 mm blade
VAE369200 25 x 35 mm blade
VAE369300 22 x 60 mm blade



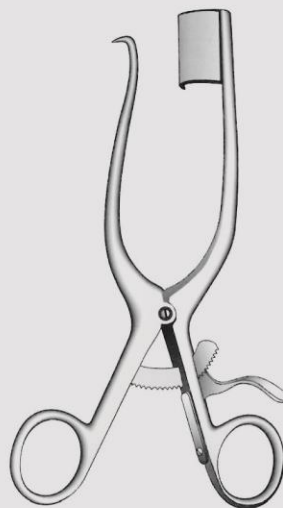
Darling
VAE369518
18 cm / 7"
(Poplitea)



Darling
VAE370018
18 cm / 7"
(Poplitea)



Spikel Shield
VAE370512 12.5 cm / 5"
VAE370518 18 cm / 7"
Left



Spikel Shield n / 5"
VAE371012 12.5 cm / 5"
VAE371018 18 cm / 7"
Right

اکار تورها



CE

SQS Certificate
ISO 9001:2000
ISO 13485:2003

171



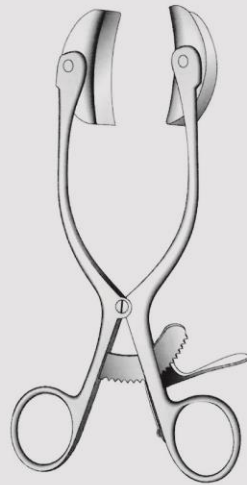
Retractors
Abdominal Retractors
Bauchdeckenhalter
Separadores Abdominales

اکار تورها
آبومینال

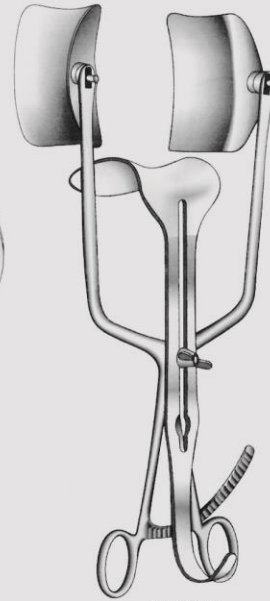


CE
SQS Certificate
ISO 9001:2000
ISO 13485:2003

172



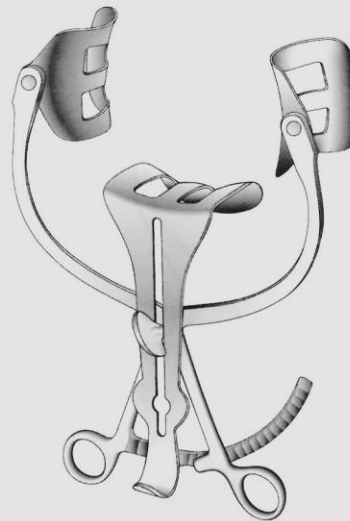
Collin, Baby
VAE371520
20 cm / 8"
Complete with 2 pairs of lateral blades
(18 x 40 mm), (27 x 40 mm)



Oettingen
VAE372015
Lateral Blades 38 x 80 mm
Center blades 50 x 65 mm
Blade opening 150 mm / 6"



Collin
VAE372525 With centerblade
VAE372625 Without centerblade
25 cm / 10"
VAE373028 With centerblade
VAE373128 Without centerblade
28 cm / 11"

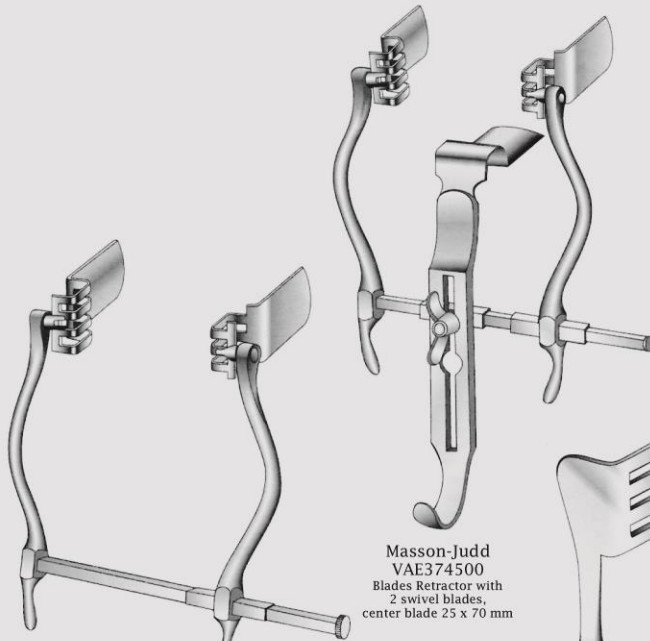


Holzbach
VAE373500 Complete
VAE373600 Spreader only
VAE373700 59x80mm lateral blades
VAE373800 74x82mm centerblade



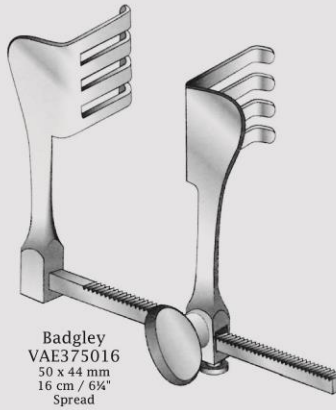
Retractors
Retractors
Wundhaken
Separadores

اکار تورها
آبدومینال

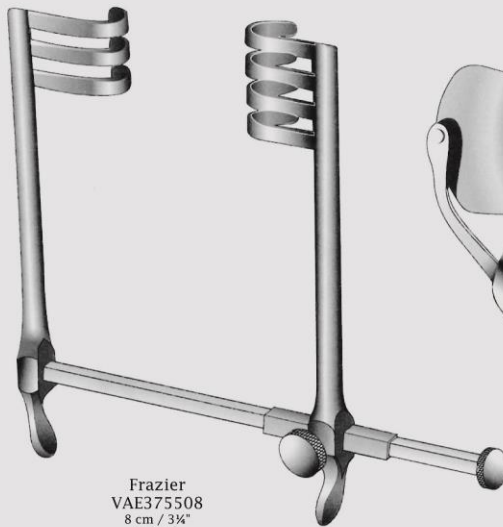


Masson-Judd
VAE374000
Bladder retractor with
2 swivel blades 25 x 70 mm

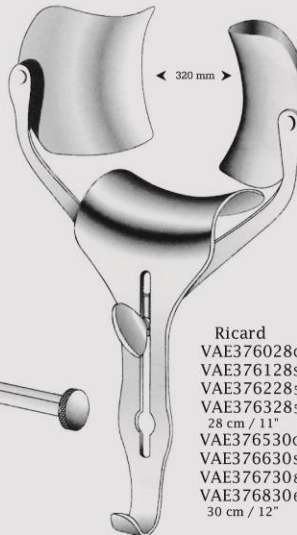
Masson-Judd
VAE374500
Blades Retractor with
2 swivel blades,
center blade 25 x 70 mm



Badgley
VAE375016
50 x 44 mm
16 cm / 6 1/4"
Spread



Frazier
VAE375508
8 cm / 3 1/4"
Spread
Laminectomy Retractor



Ricard
VAE376028 Completeset
VAE376128 Spreader only
VAE376228 55 x 70 mm center blade
VAE376328 50 x 58 mm lateral blades
28 cm / 11"
VAE376530 Completeset
VAE376630 Spreader only
VAE376730 80 x 90 mm center blade
VAE376830 60 x 80 mm lateral blades
30 cm / 12"



CE

SQS Certificate
ISO 9001:2000
ISO 13485:2003

173



Retractors
Abdominal Retractors
Bauchdeckenhalter
Separadores Abdominales

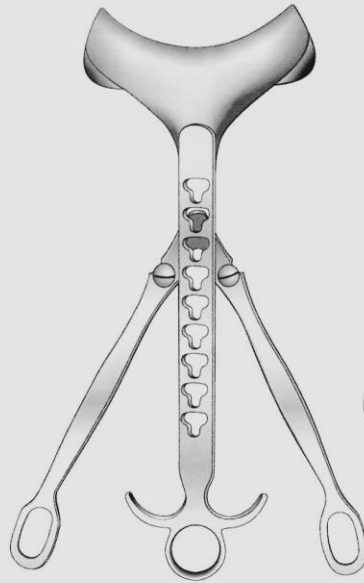
اکار تورها
آبومینال



CE

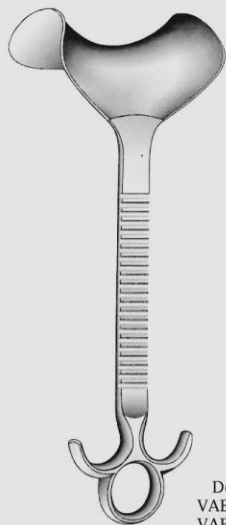
SQS Certificate
ISO 9001:2000
ISO 13485:2003

174

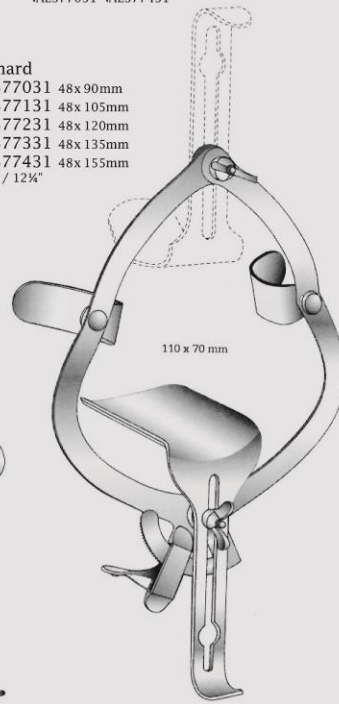
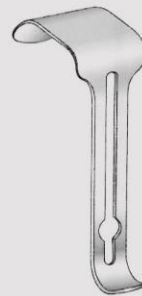


Rochard
VAE377519
19 cm / 7 1/2"
Fixation device for
VAE377031 -VAE377431

- Rochard**
VAE377031 48x90mm
VAE377131 48x105mm
VAE377231 48x120mm
VAE377331 48x135mm
VAE377431 48x155mm
31 cm / 12 1/4"



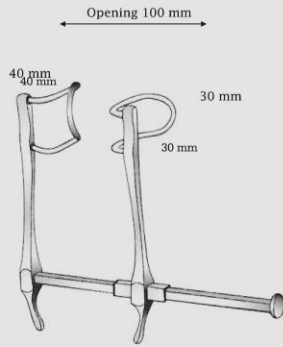
Doyen
VAE378028 48x90mm
VAE378128 48x105mm
VAE378228 48x120mm
VAE378328 48x135mm
28 cm / 11"



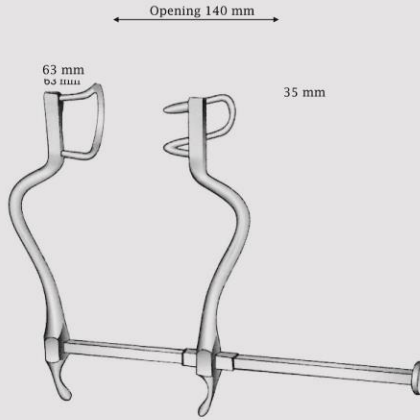
O' Sullivan-O' Connor
VAE378500
Adult
VAE378600
Baby



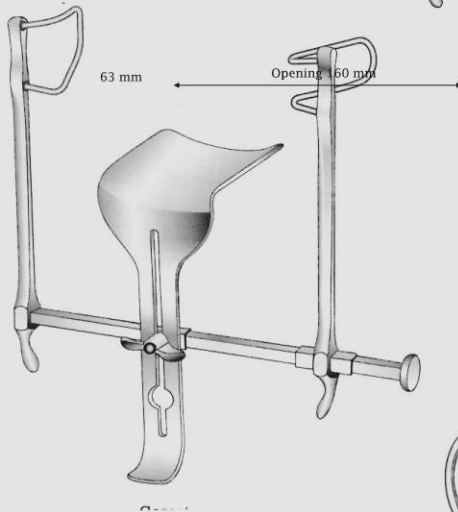
Retractors
Abdominal Retractors
Bauchdeckenhalter
Separadores Abdominales



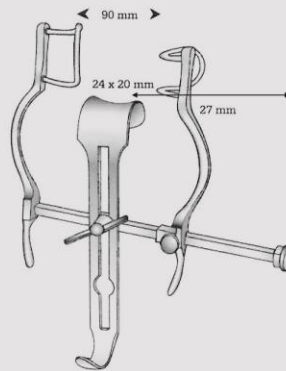
Gosset-Baby
VAE379000



Gosset
VAE379500



Gosset
VAE380000



Balfour-Baby
VAE380500 Single bar
VAE380600 Double bar

اکار تورها
آبدومینال



CE

SQS Certificate
ISO 9001:2000
ISO 13485:2003

175



Retractors
Abdominal Retractors
Bauchdeckenhalter
Separadores Abdominales

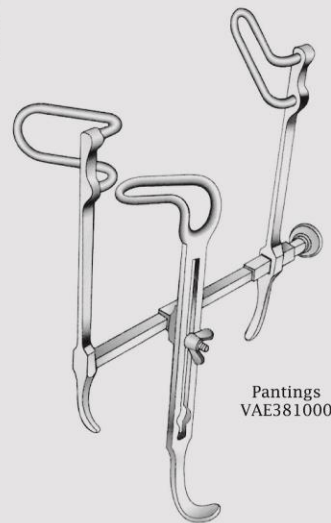
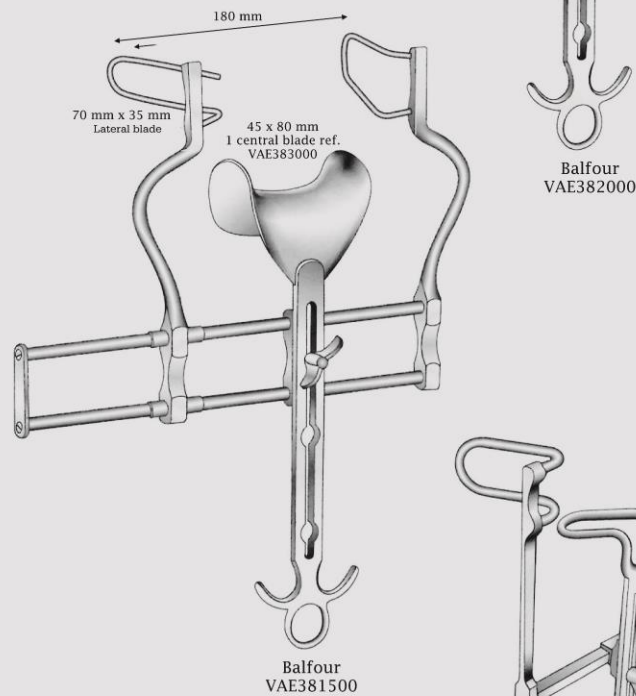
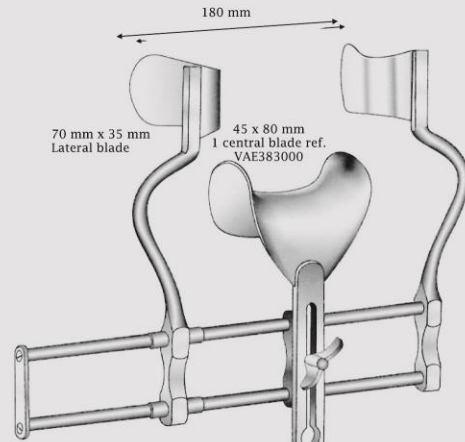
اکار تورها
آبدومینال



CE

SQS Certificate
ISO 9001:2000
ISO 13485:2003

176



Pantings
VAE381000



Retractors
Abdominal Retractors
Bauchdeckenhalter
Separadores Abdominales

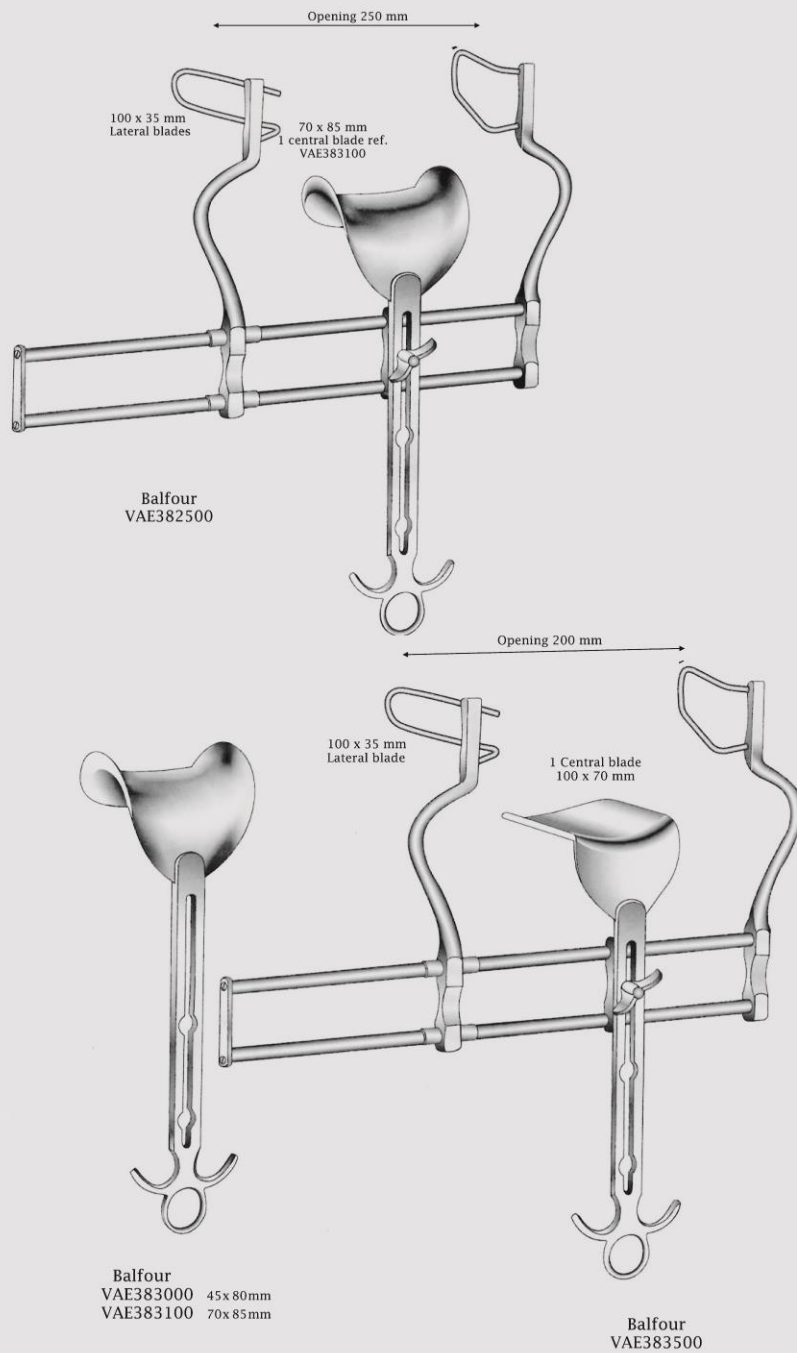
اکار تورها
آبدمینال



CE

SQS Certificate
ISO 9001:2000
ISO 13485:2003

177



Balfour
VAE382500

Balfour
VAE383000 45x80mm
VAE383100 70x85mm

Balfour
VAE383500



Retractors
Abdominal Retractors
Bauchdeckenhalter
Separadores Abdominales

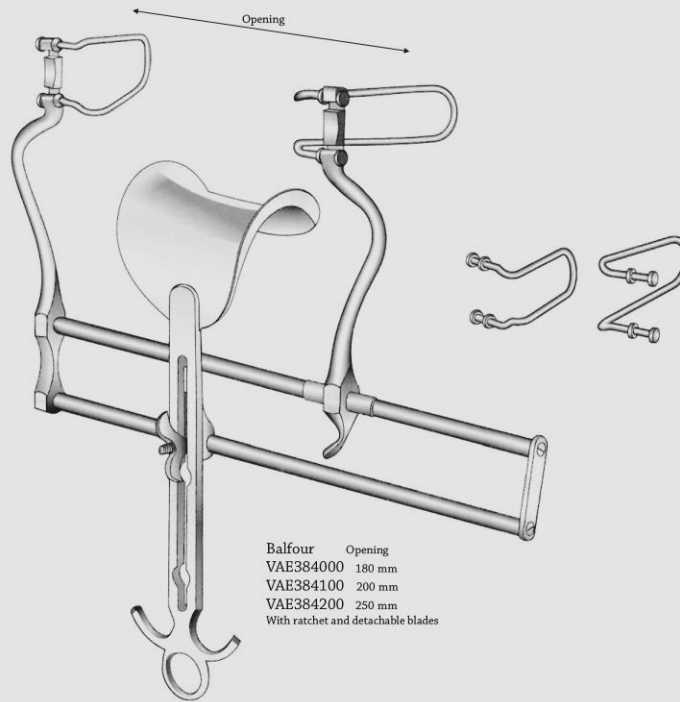
اکار تورها
آبومینال



CE

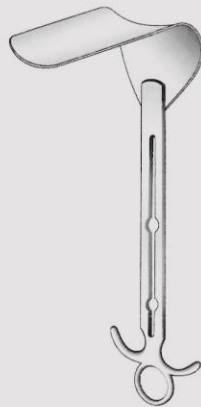
SQS Certificate
ISO 9001:2000
ISO 13485:2003

178

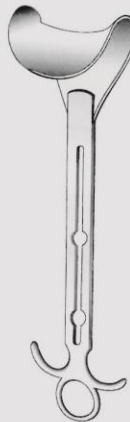


Balfour Opening
VAE384000 180 mm
VAE384100 200 mm
VAE384200 250 mm
With ratchet and detachable blades

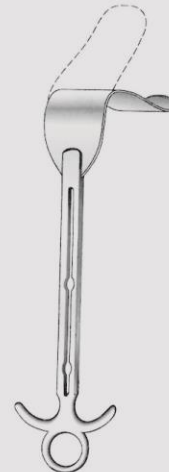
Measurements of blades: Depth x Width



VAE384500
70 x 100 mm



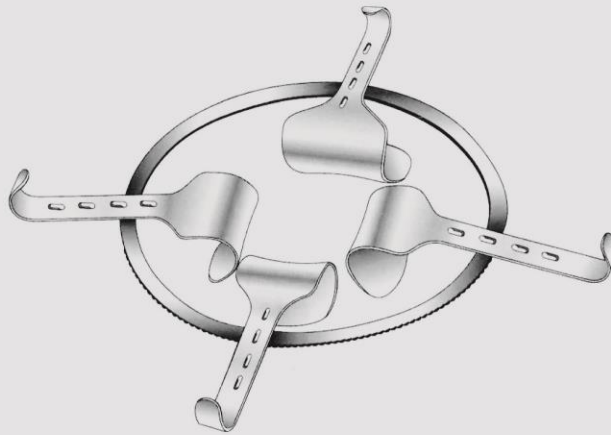
VAE385000 75 x 45 mm
VAE385100 65 x 45 mm
VAE385200 82 x 70 mm



VAE385500
50 x 127 mm



Retractors
Abdominal Retractors
Bauchdeckenhalter
Separadores Abdominales



Kirschner
Standard, oval
VAE386000
Frame only 300 x 240 mm

Kirschner
Standard, oval
VAE386100
Complete set, consisting 1 frame & 4 blades
1 frame, 300 x 240 mm
1 blade, 50 x 65 mm
1 blade, 80 x 90 mm
1 blade, 98 x 50 mm
1 blade, 105 x 35 mm

Kirschner
Standard, oval
VAE386200
Complete set, consisting 1 frame & 7 blades
1 frame, 300 x 240 mm
1 blade, 40 x 55 mm
1 blade, 50 x 65 mm
1 blade, 60 x 85 mm
1 blade, 78 x 65 mm
1 blade, 80 x 90 mm
1 blade, 98 x 50 mm
1 blade, 105 x 35 mm

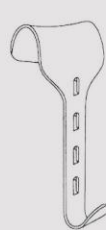
Measurements of blades: Depth x Width



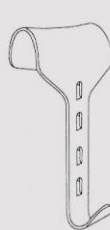
VAE386500
40 x 55 mm
Standard



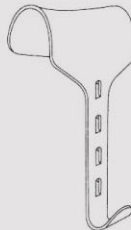
VAE386600
50 x 65 mm
Standard



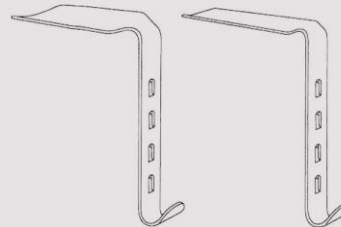
VAE386700
60 x 85 mm
Standard



VAE386800
78 x 65 mm
For obese patients



VAE386900
80 x 90 mm
For obese patients



VAE387000
98 x 50 mm
For intestinal and bladder

VAE387100
105 x 35 mm
For intestinal and bladder

اکارتورها
آبڈومینال



CE

SQS Certificate
ISO 9001:2000
ISO 13485:2003

179



Retractors
Abdominal Retractors
Bauchdeckenhalter
Separadores abdominales

اکار تورها
آبدمینال

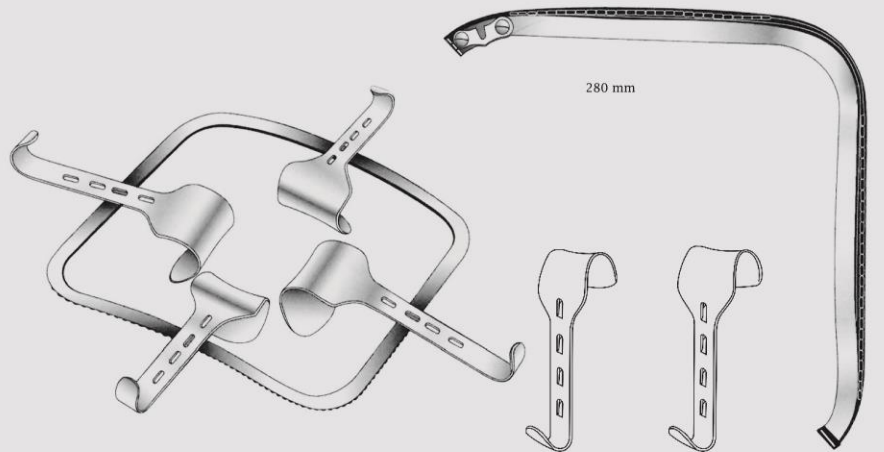


CE

SQS Certificate
ISO 9001:2000
ISO 13485:2003

180

Abdominal Retractors for new-born and children



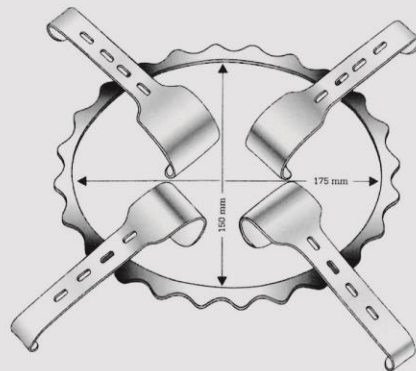
**Kirschner
VAE387500**
Complete set, consisting 1 frame & 4 blades
1 Frame, 240 x 240 mm
2 blades, 40 x 55 mm
2 blades, 50 x 65 mm

**Kirschner
VAE387600**
Frame only
240 x 240 mm

**Kirschner
VAE386500**
40 x 55 mm

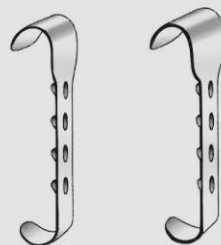
**Kirschner
VAE386600**
50 x 65 mm

VAE388000



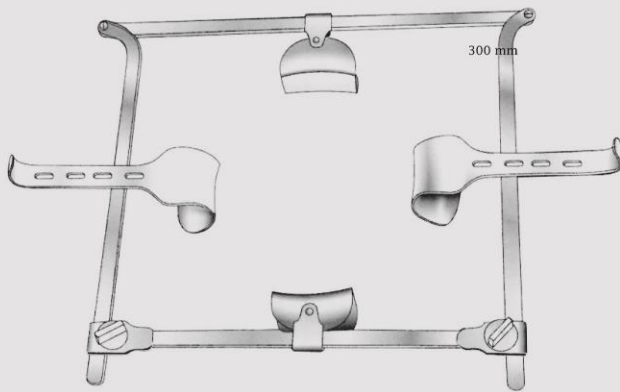
**Denis-Browne
VAE388500**
Complete set, consisting 1 frame & 4 blades
1 Frame, 150 x 175 mm
2 blades, 20 x 30 mm
2 blades, 20 x 40 mm

**Denis-Browne
VAE388600**
150 x 175 mm
Frame only

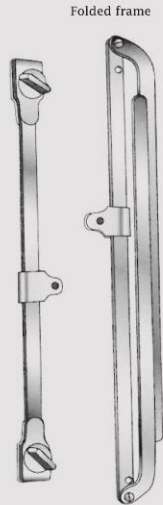


VAE389000
20 x 30 mm
Blades only

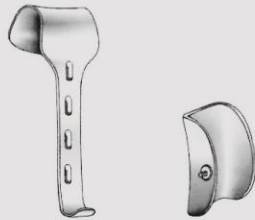
VAE389100
20 x 40 mm
Blades only



Franz
VAE389500
Complete set, consisting 1 frame & 8 blades
Folding frame, 300 x 300 mm
2 blades, 50 x 65 mm
2 blades, 60 x 85 mm
2 blades, 38 x 60 mm
2 blades, 45 x 80 mm



Franz
VAE390000
300 x 300 mm
Frame only
Folded



VAE386600
50 x 65 mm

VAE390500
38 x 60 mm



VAE386700
60 x 85 mm

VAE390600
45 x 80 mm



Retractors
Abdominal Retractors
Bauchdeckenhalter
Separadores Abdominales

اکار تورها
آبدمینال



CE

SQS Certificate
ISO 9001:2000
ISO 13485:2003

181



Retractors
Laminectomy Retractors
Laminektomiesperrer
Separadores para laminectomia

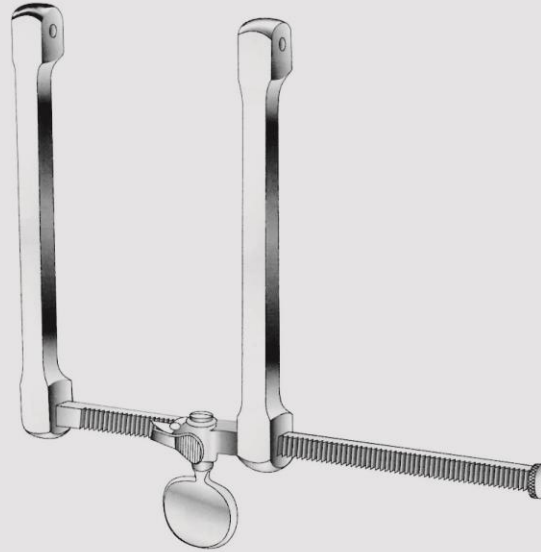
اکارتورها



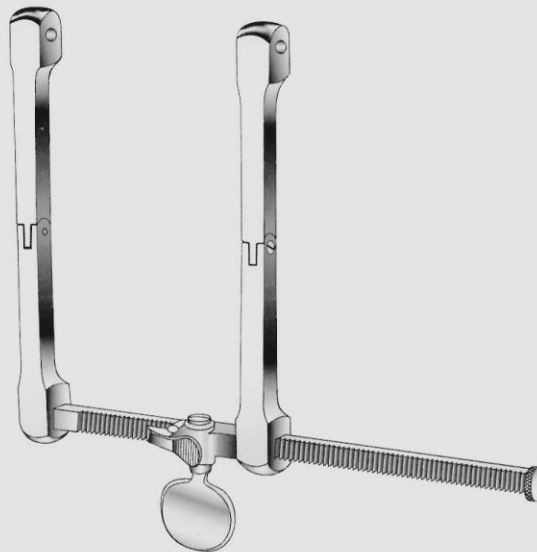
CE

SQS Certificate
ISO 9001:2000
ISO 13485:2003

182



Scoville
VAE391500
Frame only
Spreading 150 mm
VAE391600
Complete set of 13 pieces (hooks & blades)



Scoville-Haverfield
VAE391000
Frame only, with joint
Spreading 150 mm
VAE391100
Complete set of 13 pieces (hooks & blades)



Blades used with VAE391600 & VAE391100

Retractors
Laminectomy Retractors
Laminektomiesperrer
Separadores para laminectomia



Scoville
VAE392000
50 mm deep
Blunt



Scoville
VAE392500
70 mm deep
Blunt



Scoville
VAE393000
50 mm deep
Sharp



Scoville
VAE393500
70 mm deep
Sharp

اکار تورها



Scoville
VAE394000 60 x 25 mm
VAE394100 64 x 50 mm
VAE394200 88 x 25 mm
Toothed



Taylor
VAE394500 48 x 50 mm
VAE394600 64 x 50 mm
VAE394700 64 x 64 mm
VAE394800 80 x 57 mm
Sharp



Scoville
VAE395000 41 x 38 mm
VAE395100 67 x 44 mm
Sharp



CE

SQS Certificate
ISO 9001:2000
ISO 13485:2003

183



Retractors

Wound Spreaders,
Self-retaining
Wundspreizer
Separadores
autoestaticos

اکار تورها



CE

SQS Certificate
ISO 9001:2000
ISO 13485:2003

184



VAE395516
40 mm



VAE395616
45 mm



VAE395716
50 mm



VAE395816
55 mm



VAE395916
60 mm



VAE396525
40 mm



VAE396625
45 mm



VAE396725
50 mm



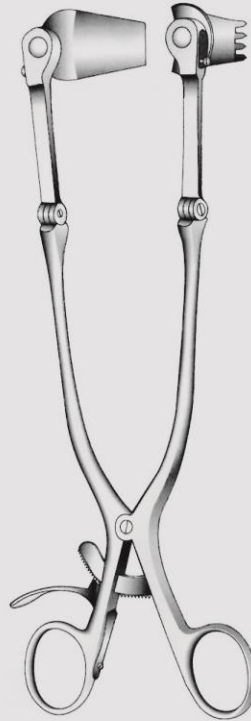
VAE396825
55 mm



VAE396925
60 mm



Cloward
16 cm / 6 1/4"



Cloward
25 cm / 10"

DIAMOND SURGICAL
WWW.DIAMONDMED.IR INSTRUMENTS



VAF

General
Instruments



CE

SQS Certificate
ISO 9001:2000
ISO 13485:2003

185



General Instruments
Abdominal Spatula
Bauchspatel
Espatulas abdominales

ملیل - جنرال



CE

SQS Certificate
ISO 9001:2000
ISO 13485:2003

186



Tessier
VAE400122
22 cm / 8 3/4"
10-12 mm
Conical, black chromium plated



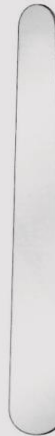
Tessier
VAE400522
22 cm / 8 3/4"
15-17 mm
Conical, black chromium plated



Tessier
VAE401022
22 cm / 8 3/4"
20-22 mm
Conical, black chromium plated



Reverdin
VAE402029
29 cm / 11 1/2"



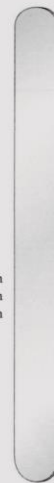
Haberer
VAE403020 20 cm / 8", 17/25 mm
VAE403028 28 cm / 11", 25/30 mm
VAE403030 30 cm / 12", 37/45 mm
Flexible



Reverdin
VAE402528
28 cm / 11"



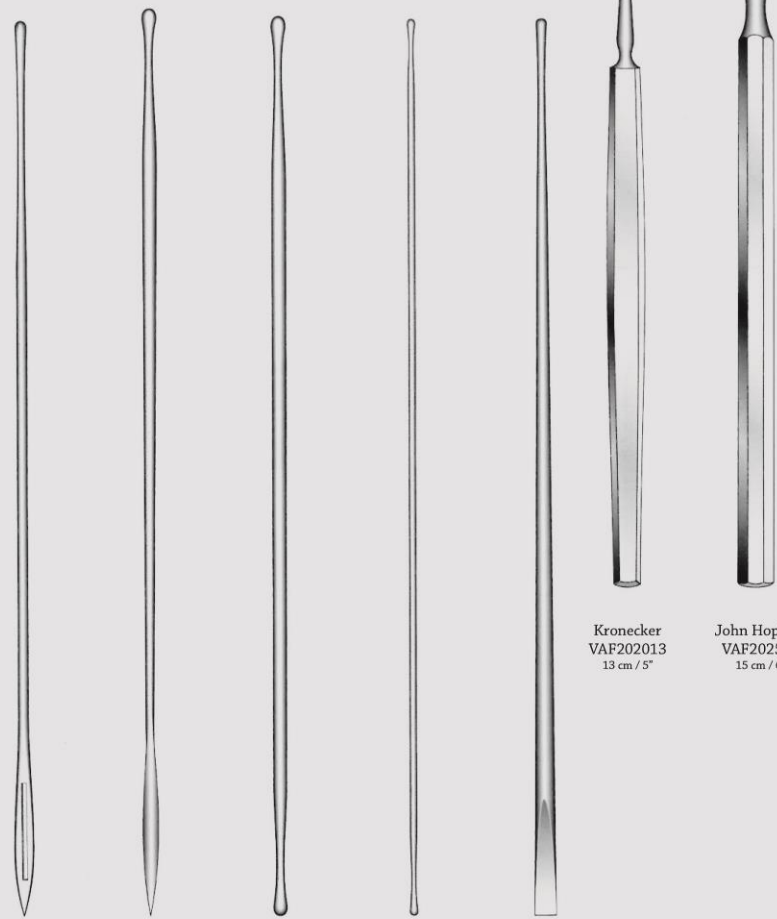
VAE401500 200 x 12 mm
VAE401600 200 x 17 mm
VAE401700 250 x 25 mm



VAE403533 30 mm
VAE403633 40 mm
VAE403733 50 mm
33 cm / 13"



General Instruments
Probes & Seekers
Sonden und Finder
Sundas Y Estiletos



Kronecker
VAF202013
13 cm / 5"

John Hopkins
VAF202515
15 cm / 6"

پروپ - جنرال



	2 mm Ø		2 mm Ø		2 mm Ø		1 mm Ø		2 mm Ø
11.5 cm / 4 1/2"	VAF020911		VAF020111		VAF020311				
12.5 cm / 5"	VAF020913	VAF020512	VAF020113	VAF020313	VAF020713				
14 cm / 5 1/2"	VAF020914	VAF020514	VAF020114	VAF020314	VAF020714				
16 cm / 6 1/4"	VAF020916	VAF020516	VAF020116	VAF020316	VAF020716				
18 cm / 7"	VAF020918		VAF020118	VAF020318					
20 cm / 8"	VAF020920		VAF020120	VAF020320					
25 cm / 10"	VAF020925			VAF020325					

CE

SQS Certificate
ISO 9001:2000
ISO 13485:2003

187



General Instruments
Grooved Directors
Hohlsonden
Sondas acanaladas

جنرال
پروپ (سوند)



CE

SQS Certificate
ISO 9001:2000
ISO 13485:2003

188



Butterfly	
VAF026111	11.5 cm / 4 3/4"
VAF026113	12.5 cm / 5"
VAF026114	14 cm / 5 1/2"
VAF026116	16.5 cm / 6 1/2"
VAF026118	18 cm / 7"
VAF026120	20.5 cm / 8"



Doyen
VAF027614
14 cm / 5 1/2"



Nelaton
VAF028614
16 cm / 6 1/4"



Roser
VAF203512
12.5 cm / 5"



General Instruments
 Aneurysm Needles & Dissectors
 Nadeln und Doppeldissektoren
 Aneurysma agujas Y Dissectores



VAF300100



Syme
 VAF300500



McDonald
 VAF301019
 19 cm / 7 3/4"



Watson-Cheyne
 VAF301517
 17.5 cm / 7"



Cheyne
 VAF302012 12.5cm/5"
 VAF302017 17.5cm/7"



VAF302513 13.5 cm / 5 1/4"
 VAF302514 14 cm / 5 1/2"



VAF303017
 17.5 cm / 7"

جنرال
 پریوسٹ الویتور



CE

SQS Certificate
 ISO 9001:2000
 ISO 13485:2003

189



General Instruments
Cotton Applicators
Watteträger
Porta-algodones

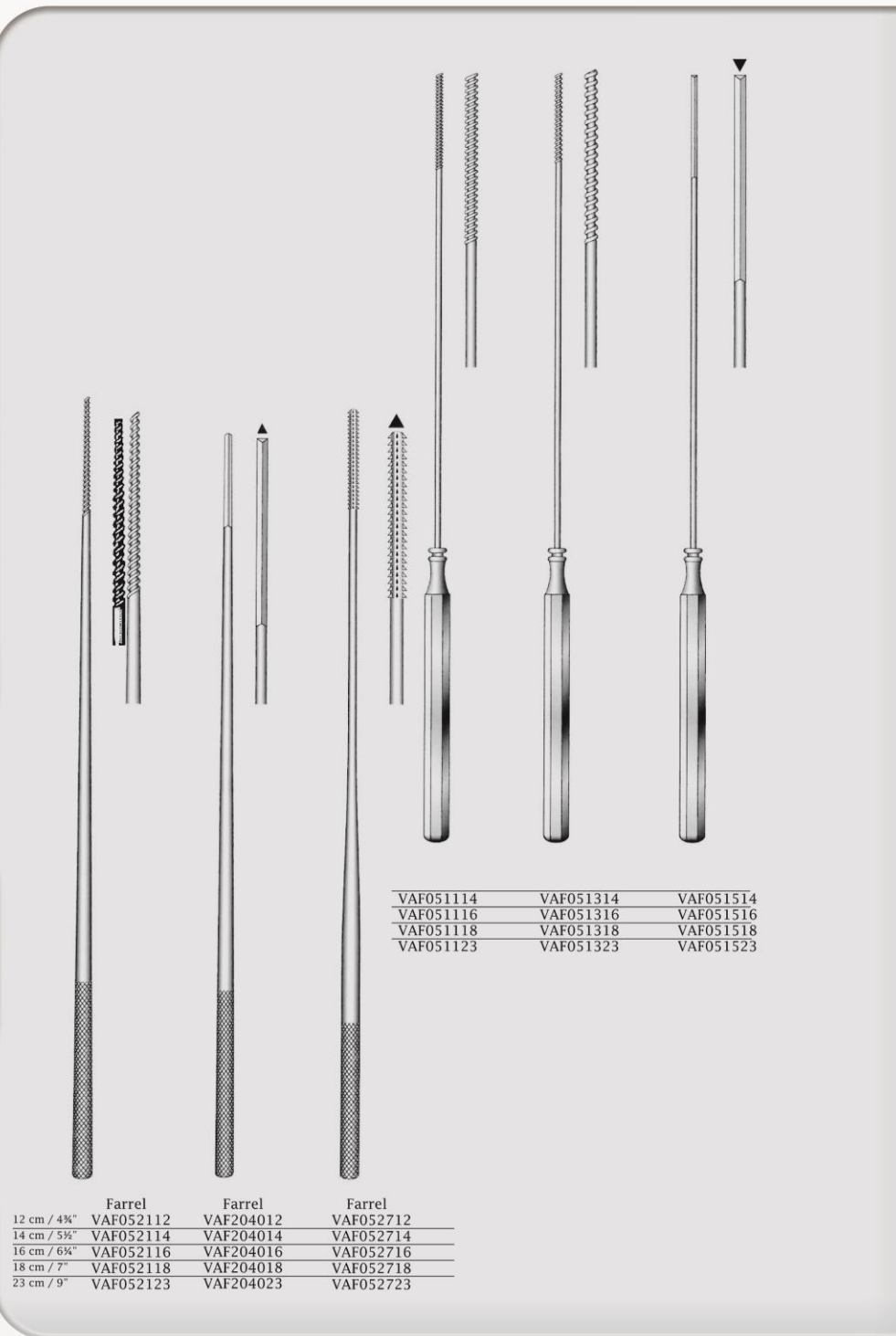
جنرال
پنبه پیچ



CE

SQS Certificate
ISO 9001:2000
ISO 13485:2003

190

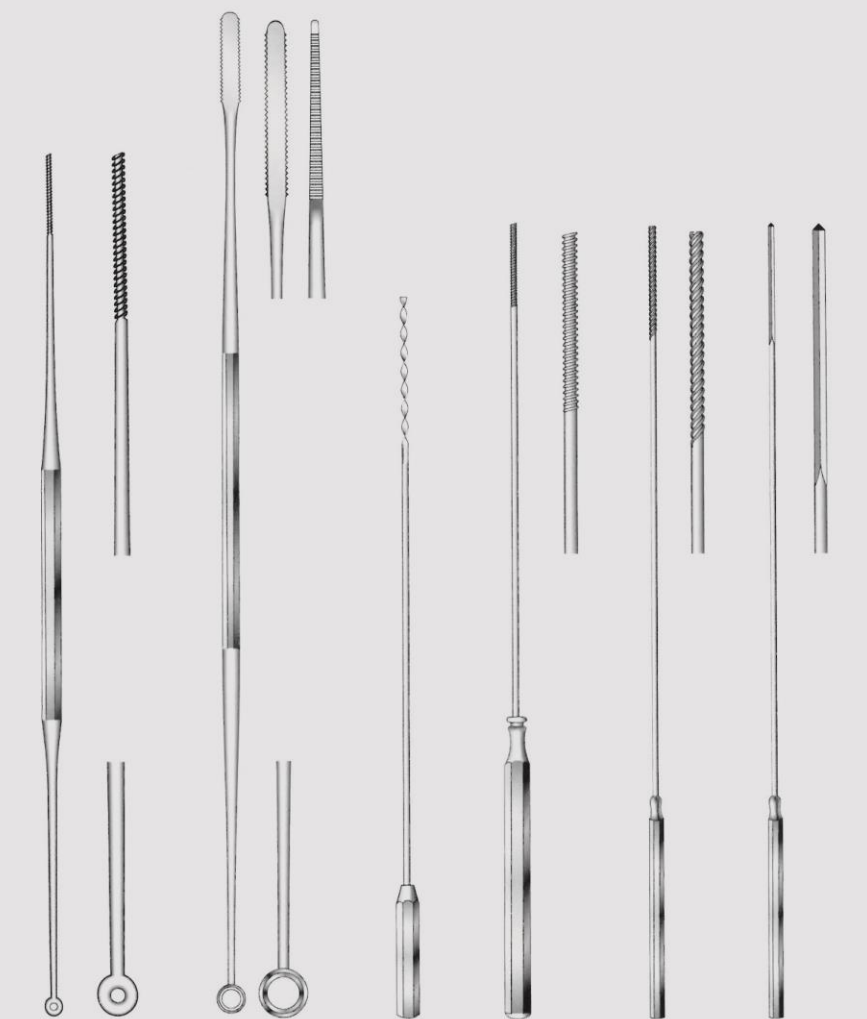


VAF051114	VAF051314	VAF051514
VAF051116	VAF051316	VAF051516
VAF051118	VAF051318	VAF051518
VAF051123	VAF051323	VAF051523

	Farrel	Farrel	Farrel
12 cm / 4 3/4"	VAF052112	VAF204012	VAF052712
14 cm / 5 1/2"	VAF052114	VAF204014	VAF052714
16 cm / 6 1/4"	VAF052116	VAF204016	VAF052716
18 cm / 7"	VAF052118	VAF204018	VAF052718
23 cm / 9"	VAF052123	VAF204023	VAF052723



General Instruments
Cotton Applicators
Watteträger
Porta-algodones



Ukermann
VAF204515
15 cm / 6"

Jobson-Horne
VAF056512 12.5cm/5"
VAF056518 18cm/7"

VAF205025
25 cm / 10"

VAF205528
28 cm / 11"

VAF206028
28 cm / 11"

VAF206528
28 cm / 11"

جنرال
پنبه پیچ



CE

SQS Certificate
ISO 9001:2000
ISO 13485:2003

191



General Instruments
Cotton Applicators and Sponge Holder
Watteträger und Schwammhalter
Porta-algodones y Porta-esponjas

جنرال
پنبه پیچ



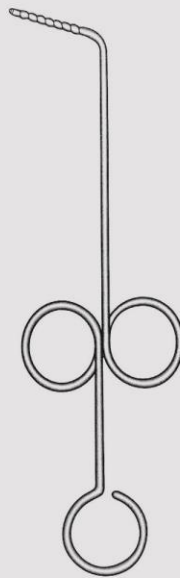
CE

SQS Certificate
ISO 9001:2000
ISO 13485:2003

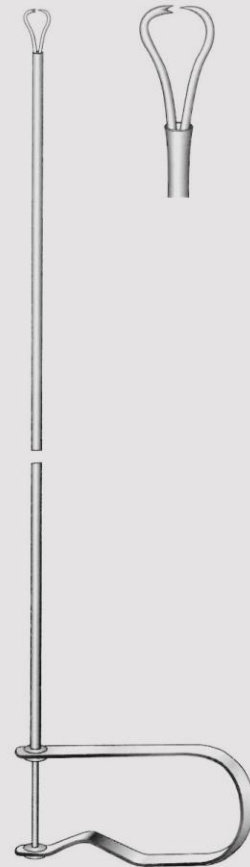
192



Tobold
VAF207025
25 cm / 10"

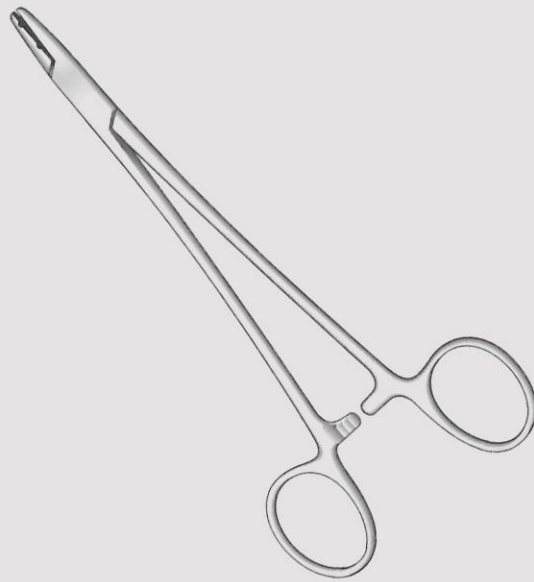


Hartmann
VAF207520
20 cm / 8"



VAF303537
37.5 cm / 15"
VAF303545
45 cm / 17 1/2"

DIAMOND SURGICAL
WWW.DIAMONDMED.IR INSTRUMENTS



VBZ

Needle Holder



CE

SQS Certificate
ISO 9001:2000
ISO 13485:2003

193



Needle Holders
Needle Holders
Nadelhalter
Porta-agujas

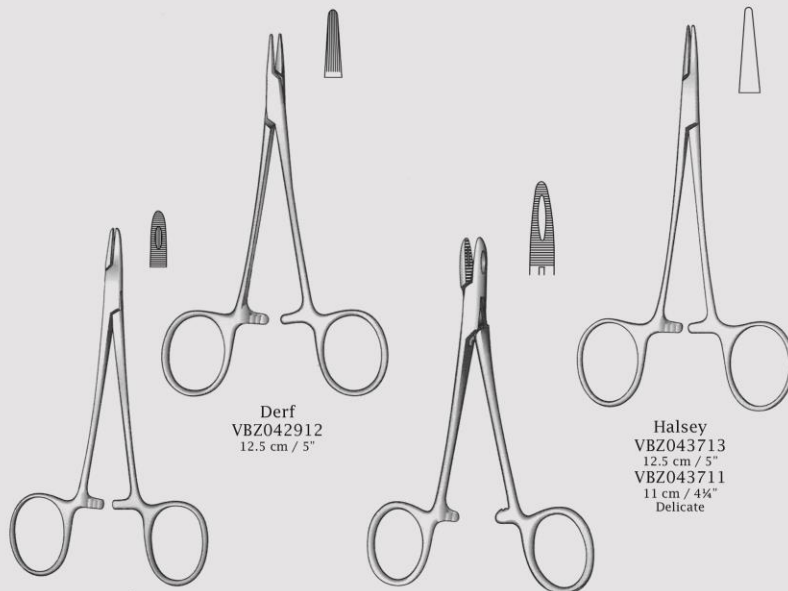
سوزنگیرها



CE

SQS Certificate
ISO 9001:2000
ISO 13485:2003

194

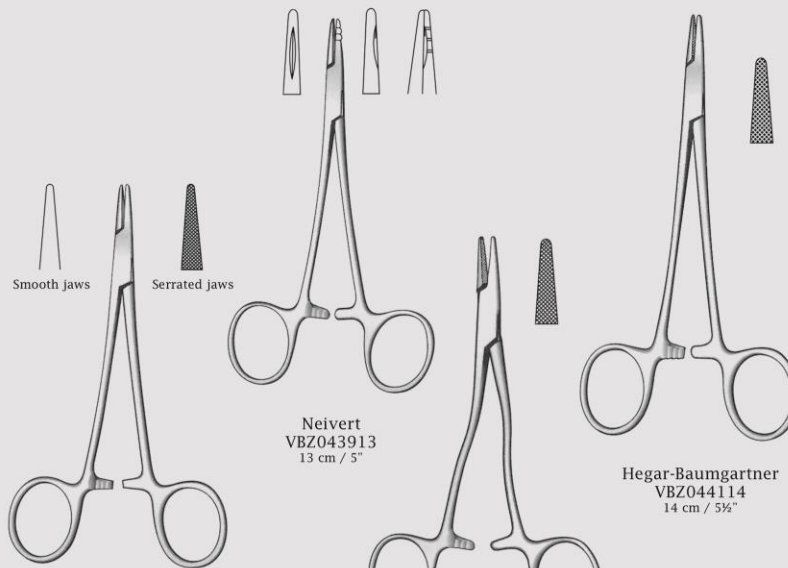


Derf
VBZ042912
12.5 cm / 5"

Halsey
VBZ043713
12.5 cm / 5"
VBZ043711
11 cm / 4 1/4"
Delicate

Derf
VBZ042712
12 cm / 4 3/4"

Collier
VBZ043312
12.5 cm / 5"



Smooth jaws

Serrated jaws

Neivert
VBZ043913
13 cm / 5"

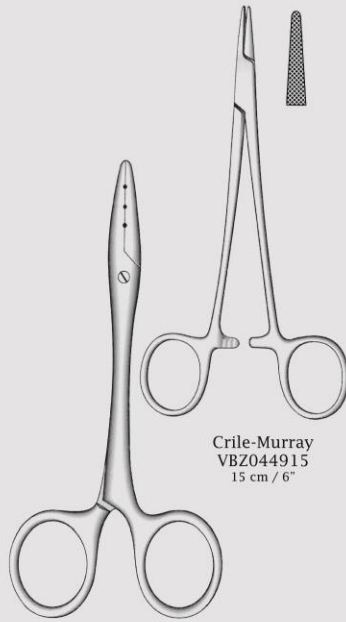
Hegar-Baumgartner
VBZ044114
14 cm / 5 1/2"

Webster
VBZ043513 Smooth
VBZ300113 Serrated
13 cm / 5"
Delicate

Kilner
VBZ073213
13.5 cm / 5 1/4"



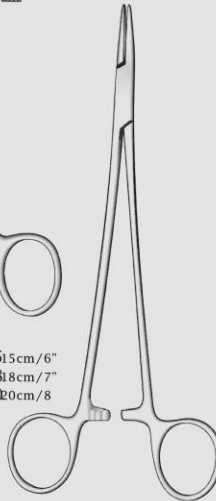
Needle Holders
Needle Holders
Nadelhalter
Porta-agujas



Crile-Murray
VBZ044915
15 cm / 6"



Crile-wood
VBZ045115 15cm / 6"
VBZ045118 18cm / 7"
VBZ045120 20cm / 8"



Mayo-Hegar
Delicate

VBZ049716
16 cm / 6 1/4"

VBZ049718
18 cm / 7"

VBZ049720
20 cm / 8"

Bruce-Clarke
VBZ201012
12.5 cm / 5"



VBZ049114
14 cm / 5 1/2"

VBZ049116
16 cm / 6 1/4"



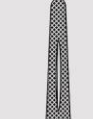
VBZ049118
18 cm / 7"



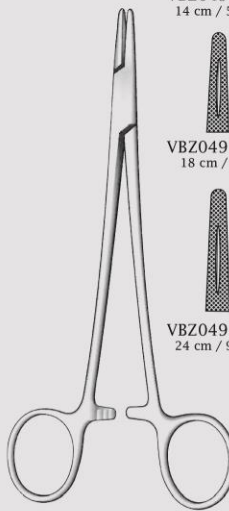
VBZ049120
20 cm / 8"



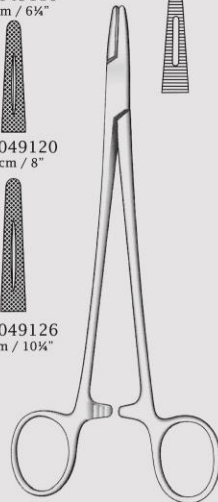
VBZ049124
24 cm / 9 1/2"



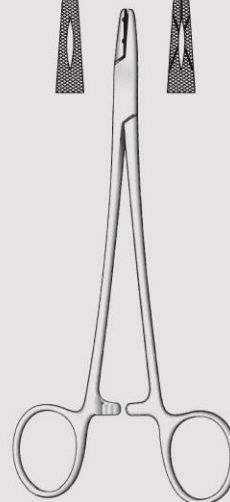
VBZ049126
26 cm / 10 1/4"



Mayo-Hegar



Adson
VBZ046118
18 cm / 7"



Metzenbaum
VBZ046518
18 cm / 7"

سوزنگیرها



CE

SQS Certificate
ISO 9001:2000
ISO 13485:2003

195



Needle Holders
Nadelhalter
Nadelhalter
Porta-agujas

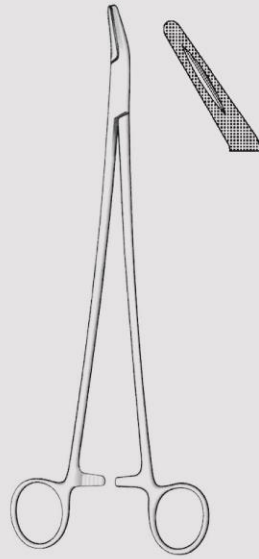
سوزنگیر ها



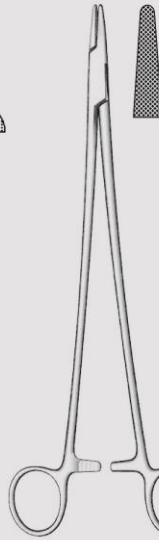
CE

SQS Certificate
ISO 9001:2000
ISO 13485:2003

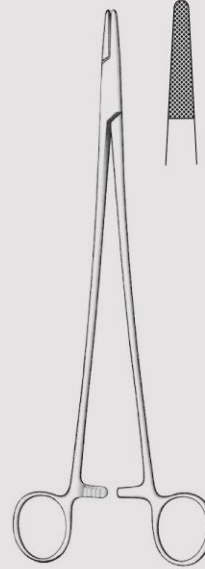
196



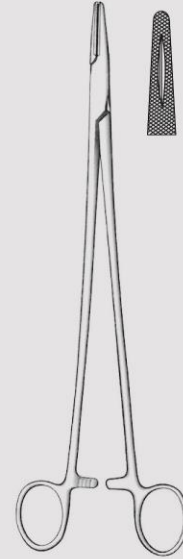
Finocchio
VBZ300527
27 cm / 10 1/2"



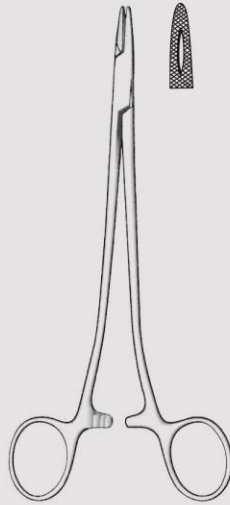
Wangenstein
VBZ301027
27 cm / 10 1/2"



Wangenstein
VBZ301527
27 cm / 10 1/2"



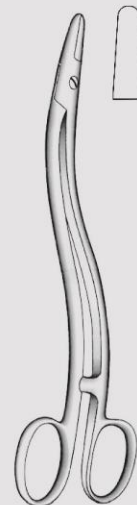
Masson
VBZ302027
27 cm / 10 1/2"



Sarot
VBZ302518 18cm / 7"
VBZ302526 26cm / 10 1/4"



Heaney
VBZ303021
21 cm / 8 1/4"



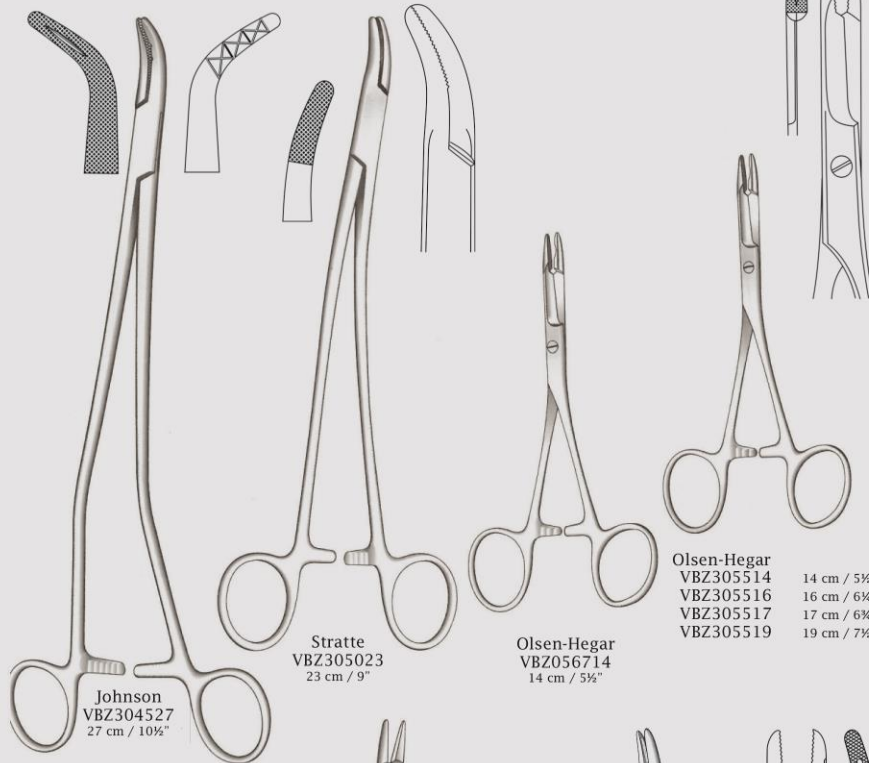
Thomson-Walker
VBZ303520
20 cm / 8"



Bozemann
VBZ304020 20cm / 8"
VBZ304024 24cm / 9 1/2"



Needle Holders
Needle Holders
Nadelhalter
Porta-agujas



Johnson
VBZ304527
27 cm / 10½"

Stratte
VBZ305023
23 cm / 9"

Olsen-Hegar
VBZ056714
14 cm / 5½"

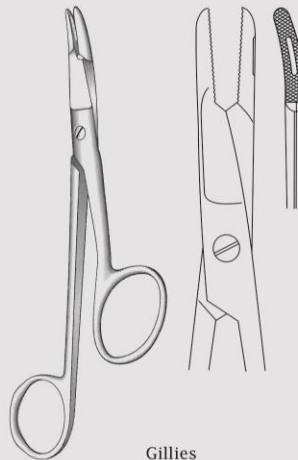
Olsen-Hegar
VBZ305514 14 cm / 5½"
VBZ305516 16 cm / 6¼"
VBZ305517 17 cm / 6¾"
VBZ305519 19 cm / 7½"



Mini Gillies
10 cm / 4"
VBZ202510 Left hand
VBZ202610 Right hand



Foster Gillies
VBZ201512 Righthand
VBZ201612 Lefthand
12.5 cm / 5"
Serrated jaws



Gillies
VBZ057016 Righthand
VBZ202016 Left hand
16 cm / 6¼"
Serrated jaws

سوزنگیرها



CE

SQS Certificate
ISO 9001:2000
ISO 13485:2003

197



Needle Holders

Needle Holders
Nadelhalter
Porta-agujas

سوز نگیرها



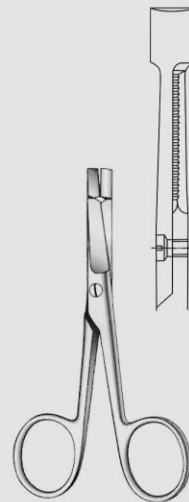
CE

SQS Certificate
ISO 9001:2000
ISO 13485:2003

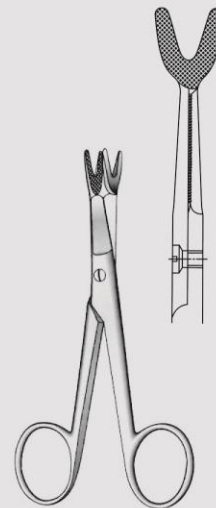
198



Olsen-Hegar
VBZ056512 12cm/4¾", Mini
VBZ056514 14 cm/5½"
VBZ056516 16cm/6¼"
VBZ056518 18cm/7"



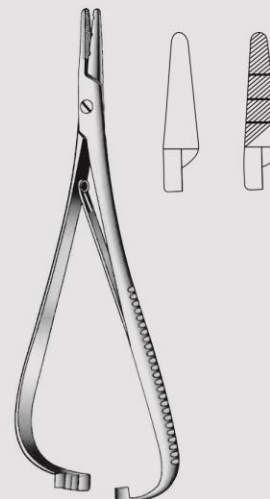
Eiselsberg
VBZ306011
11.5 cm / 4½"



Schoemaker-Loth
VBZ306512
12.5 cm / 5"



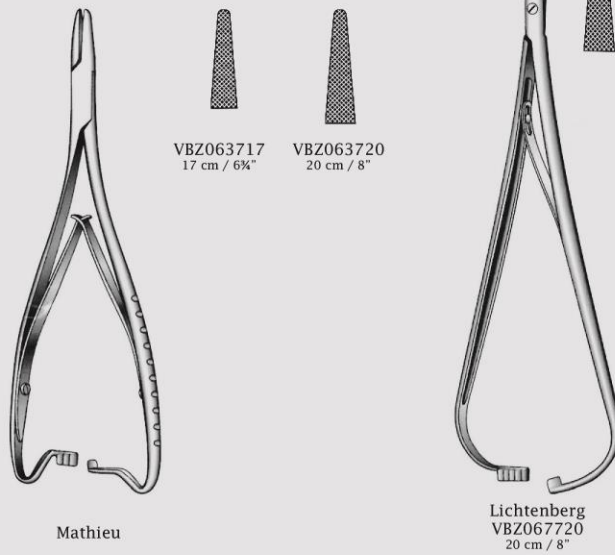
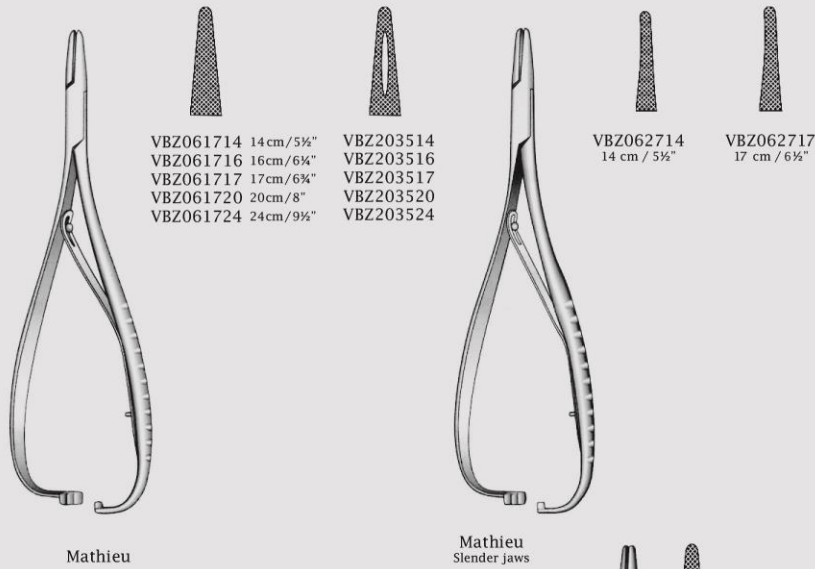
Crile
VBZ060115
15 cm / 6"



MacPhail
(Cooper jaw)
VBZ203014 14cm/5½"
VBZ203016 16cm/6¼"
VBZ203018 18cm/7"
VBZ203020 20cm/8"



Needle Holders
Needle Holders
Nadelhalter
Porta-agujas



سوزنگیرها



CE

SQS Certificate
ISO 9001:2000
ISO 13485:2003

199



Needle Holders
 Needle Holders
 Nadelhalter
 Porta-agujas

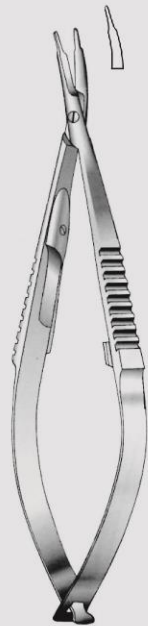
سوز نگیرها



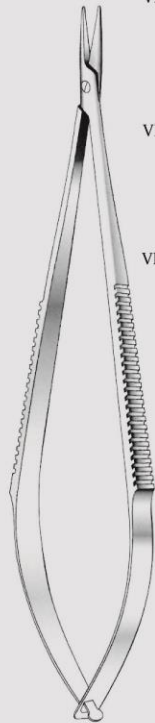
CE

SQS Certificate
 ISO 9001:2000
 ISO 13485:2003

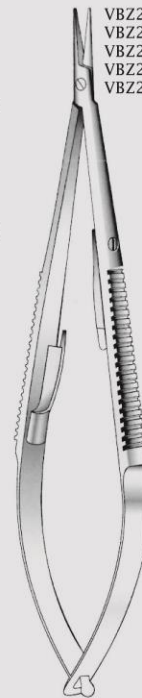
200



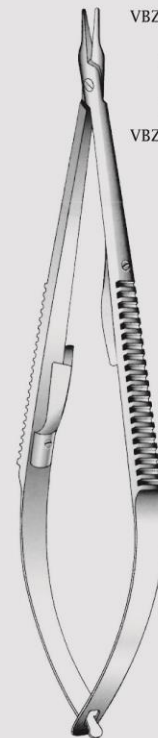
McPherson
 VBZ204410
 10 cm / 4"



Castroviejo
 13.5 cm / 5 1/2"
 Without lock



Castroviejo
 With lock



Castroviejo
 13.5 cm / 5 1/2"
 Extra delicate, with lock

VBZ041314		VBZ205013 13 cm / 5 1/4"		VBZ205513
		VBZ205016 16 cm / 6 3/4"		VBZ205516
		VBZ205018 18 cm / 7"		VBZ205518
		VBZ205020 20 cm / 8"		VBZ205520
		VBZ205023 23 cm / 9"		VBZ205523

VBZ041414		VBZ205113 13 cm / 5 1/4"		VBZ205613
		VBZ205116 16 cm / 6 3/4"		VBZ205616
		VBZ205118 18 cm / 7"		VBZ205618
		VBZ205120 20 cm / 8"		VBZ205620
		VBZ205123 23 cm / 9"		VBZ205623

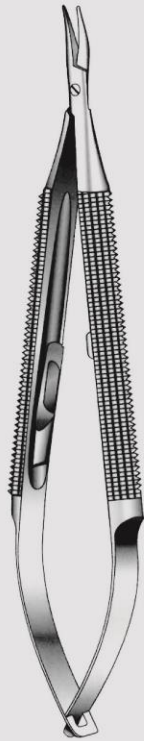
VBZ204514		VBZ040714		
VBZ204614		VBZ040814		



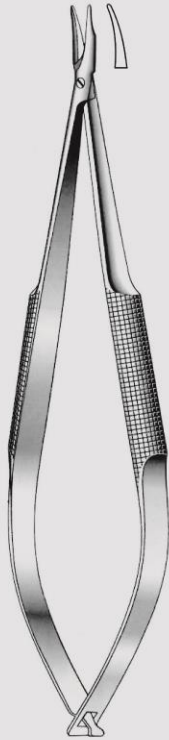
Needle Holders
Needle Holders
Nadelhalter
Porta-agujas

VBZ038913	13cm / 5¼"	VBZ307013
VBZ038916	16cm / 6¼"	VBZ307016
VBZ038918	18cm / 7"	VBZ307018
VBZ038920	20 cm / 8"	VBZ307020
VBZ038923	23 cm / 9"	VBZ307023
With lock		With lock
VBZ039013	13 cm / 5¼"	VBZ307113
VBZ039016	16 cm / 6¼"	VBZ307116
VBZ039018	18 cm / 7"	VBZ307118
VBZ039020	20 cm / 8"	VBZ307120
VBZ039023	23 cm / 9"	VBZ307123
Without lock		Without lock

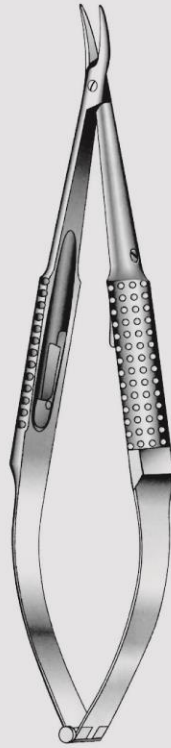
VBZ040113 13cm / 5¼"
VBZ040116 16cm / 6¼"
VBZ040118 18cm / 7"
VBZ040120 20cm / 8"
VBZ040123 23 cm / 9"
With lock



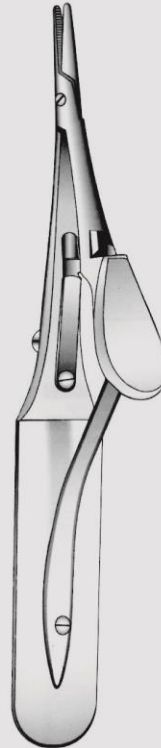
Barraquer-Troutman



Barraquer
VBZ307513
13 cm / 5¼"



Barraquer



Arruga
VBZ039114 Straight
VBZ205814 Curved
14 cm / 5½"



Stevens
VBZ206016
16.5 cm / 6½"
With ratchet lock

سوز نگیرها



SQS Certificate
ISO 9001:2000
ISO 13485:2003

201



Needle Holders
Needle Holders
Nadelhalter
Porta-agujas

سوز نگیرها



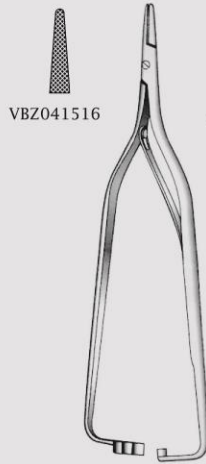
CE

SQS Certificate
ISO 9001:2000
ISO 13485:2003

202

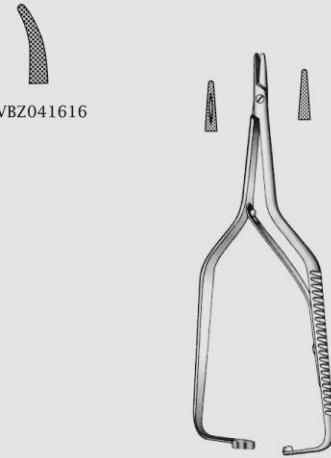


Kalt
VBZ037514
13 cm / 5 1/4"
Standard model
Delicate jaws



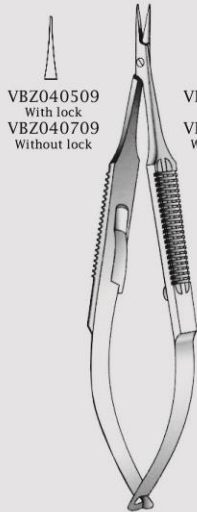
VBZ041516

Arruga
16 cm / 6 1/4"



VBZ041616

Boynton
VBZ206512
12.5 cm / 5"
Delicate



VBZ040509
With lock
VBZ040709
Without lock

Castroviejo
9 cm / 3 1/2"



VBZ040609
With lock
VBZ040809
Without lock



Castroviejo
VBZ041712
12 cm / 4 3/4"



Castroviejo Barraquer
VBZ041812
12 cm / 4 3/4"



Castroviejo
VBZ041713
13 cm / 5"



Needle Holders
Needle Holders
Nadelhalter
Porta-agujas

Instruments with Tungsten Carbide Inserts
Tc Gold

Derf
VBZ073312T
12 cm / 4 3/4"

0.4
Mini profile
Mini profil
Profil mini

Webster
VBZ073812T
VBZ207012T
12 cm / 4 3/4"

Smooth
glett
Lisas

Serrated

Webster
VBZ073113T
VBZ207513T
12 cm / 4 3/4"

Delicate

Kilner
VBZ073213T
13.5 cm / 5 1/4"

0.5
Normal profile
Normal profil
Profil normal

Halsey
13 cm / 5"

VBZ073713T
Plain
Smooth
Glett
Lisas

0.4
Mini profile
Mini profil
Profil mini

Hegar-Baumgartner

VBZ070513T
For right hand
VBZ071013T
For left hand
13 cm / 5"

0.4
Mini profile
Mini profil
Profil mini

VBZ070515T
For right hand
VBZ071015T
For left hand
15 cm / 6"

0.5
Normal profile
Normal profil
Profil normal

VBZ073513T
13 cm / 5"

0.5
Normal profile
Normal profil
Profil normal

VBZ073514T
14 cm / 5 1/2"

With automatic release ratchet
also for left handers

سوز نگیرها



CE
SQS Certificate
ISO 9001:2000
ISO 13485:2003

203



Needle Holders

Needle Holders
Nadelhalter
Porta-agujas

سوز نگیرها


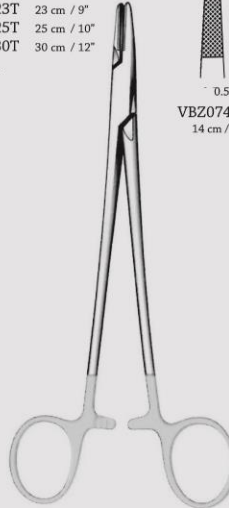

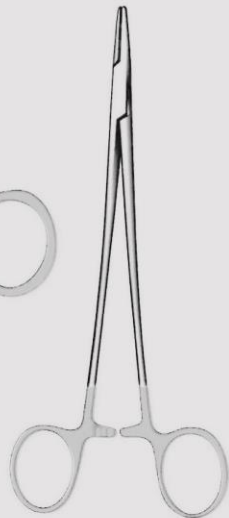


CE

SQS Certificate
ISO 9001:2000
ISO 13485:2003

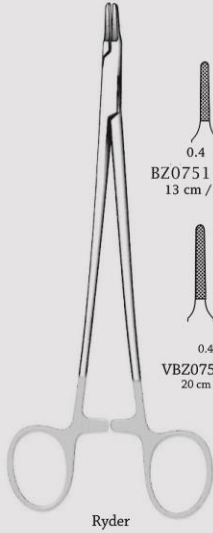
204

Instruments with Tungsten Carbide Inserts
Tc Gold

 <p>Criele-wood</p>	<p>0.4</p> <p>VBZ073915T 15 cm / 6" VBZ073918T 18 cm / 7" VBZ073920T 20 cm / 8" VBZ073923T 23 cm / 9" VBZ073925T 25 cm / 10" VBZ073930T 30 cm / 12"</p> <p>Mini profile Mini profil Profil mini</p>	 <p>Mayo-Hegar</p>	<p>0.5</p> <p>VBZ074314T 14 cm / 5 1/4"</p> <p>0.5</p> <p>VBZ074316T 16 cm / 6 1/4"</p> <p>0.5</p> <p>VBZ074318T 18 cm / 7"</p> <p>0.5</p> <p>VBZ074320T 20 cm / 8"</p> <p>0.5</p> <p>VBZ074324T 24 cm / 9 1/4"</p> <p>0.5</p> <p>VBZ074326T 26 cm / 10 1/4"</p> <p>0.5</p> <p>VBZ074330T 30 cm / 12"</p> <p>0.5</p> <p>VBZ074335T 35 cm / 14"</p> <p>0.5</p> <p>VBZ074340T 40 cm / 16"</p> <p>0.5</p> <p>VBZ074345T 45 cm / 18"</p> <p>Normal profile Normal profil Profil normal</p>	<p>0.4</p> <p>VBZ074718T 18 cm / 7"</p> <p>0.4</p> <p>VBZ074720T 20 cm / 8"</p> <p>0.4</p> <p>VBZ074723T 23 cm / 9"</p> <p>0.4</p> <p>VBZ074726T 26 cm / 10 1/4"</p> <p>0.4</p> <p>VBZ074731T 31 cm / 12 1/4"</p> <p>0.4</p> <p>VBZ074737T 37 cm / 14 1/4"</p> <p>Mini profile Mini profil Profil mini</p>
 <p>VBZ308011T 11 cm / 4 1/4" Special pattern</p>	 <p>De Bakery</p>			

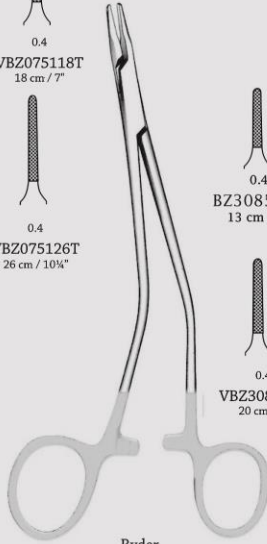


Instruments with Tungsten Carbide Inserts
Tc Gold



Ryder

- 0.4
BZ075113T
13 cm / 5"
 - 0.4
BZ075115T
15 cm / 6"
 - 0.4
VBZ075118T
18 cm / 7"
 - 0.4
VBZ075120T
20 cm / 8"
 - 0.4
VBZ075123T
23 cm / 9"
 - 0.4
VBZ075126T
26 cm / 10 1/4"
- Mini profil
Mini profil
Profil mini



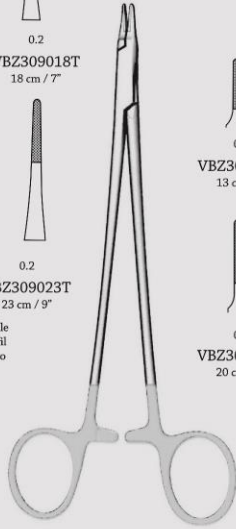
Ryder
Angled

- 0.4
BZ308513T
13 cm / 5"
 - 0.4
BZ308515T
15 cm / 6"
 - 0.4
VBZ308518T
18 cm / 7"
 - 0.4
VBZ308520T
20 cm / 8"
 - 0.4
VBZ308523T
23 cm / 9"
 - 0.4
VBZ308526T
26 cm / 10 1/4"
- Mini profil
Mini profil
Profil mini



Hegar-Vascular

- 0.2
VBZ309014T
14 cm / 5 1/2"
 - 0.2
VEZ309018T
18 cm / 7"
 - 0.2
VBZ309020T
20 cm / 8"
 - 0.2
VBZ309023T
23 cm / 9"
- Micro profil
Mikro profil
Profil micro



Ryder-Vascular

- 0.2
VBZ309513T
13 cm / 5"
 - 0.2
VBZ309515T
15 cm / 6"
 - 0.2
VBZ309518T
18 cm / 7"
 - 0.2
VBZ309520T
20 cm / 8"
 - 0.2
VBZ309523T
23 cm / 9"
 - 0.2
VBZ309526T
26 cm / 10 1/4"
- Micro profil
Mikro profil
Profil micro

Needle Holders
Needle Holders
Nadelhalter
Porta-agujas

سوز نگیرها



SQS Certificate
ISO 9001:2000
ISO 13485:2003





Needle Holders
Needle Holders
Nadelhalter
Porta-agujas

سوز نگیرها



CE

SQS Certificate
ISO 9001:2000
ISO 13485:2003

206

Instruments with Tungsten Carbide Inserts

Tc Gold



0.5

VBZ310022T
22 cm / 8½"

Right



0.5

VBZ310522T
22 cm / 8½"

Left

VBZ310023T
23 cm / 9"

Right

VBZ310523T
23 cm / 9"

Left

Normal profile
Normal profil
Profil normal



0.5

VBZ311520T
20 cm / 8"



0.5

VBZ311524T
24 cm / 9½"



0.5

VBZ311526T
26 cm / 10¼"

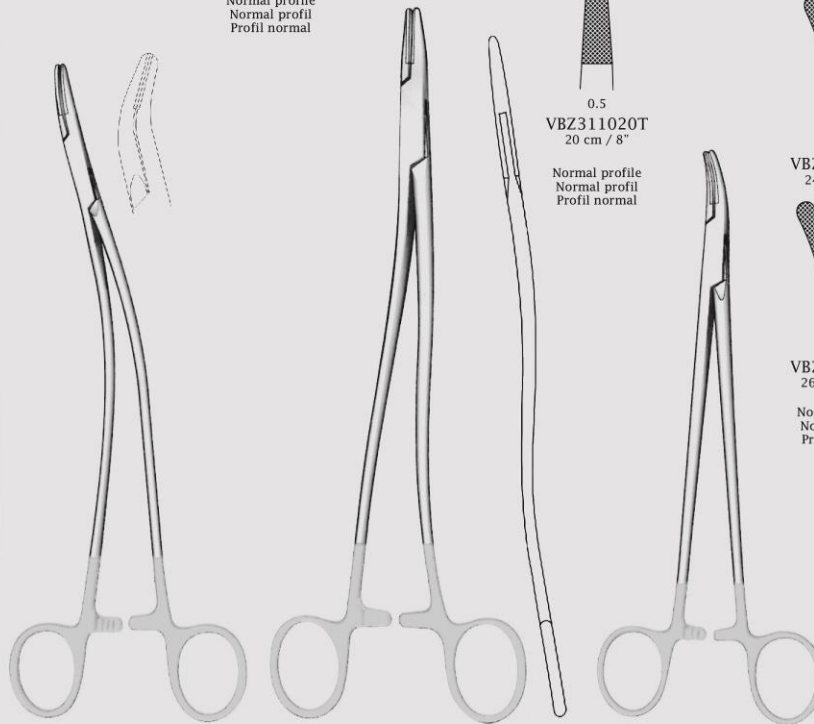
Normal profile
Normal profil
Profil normal



0.5

VBZ311020T
20 cm / 8"

Normal profile
Normal profil
Profil normal



Stratte

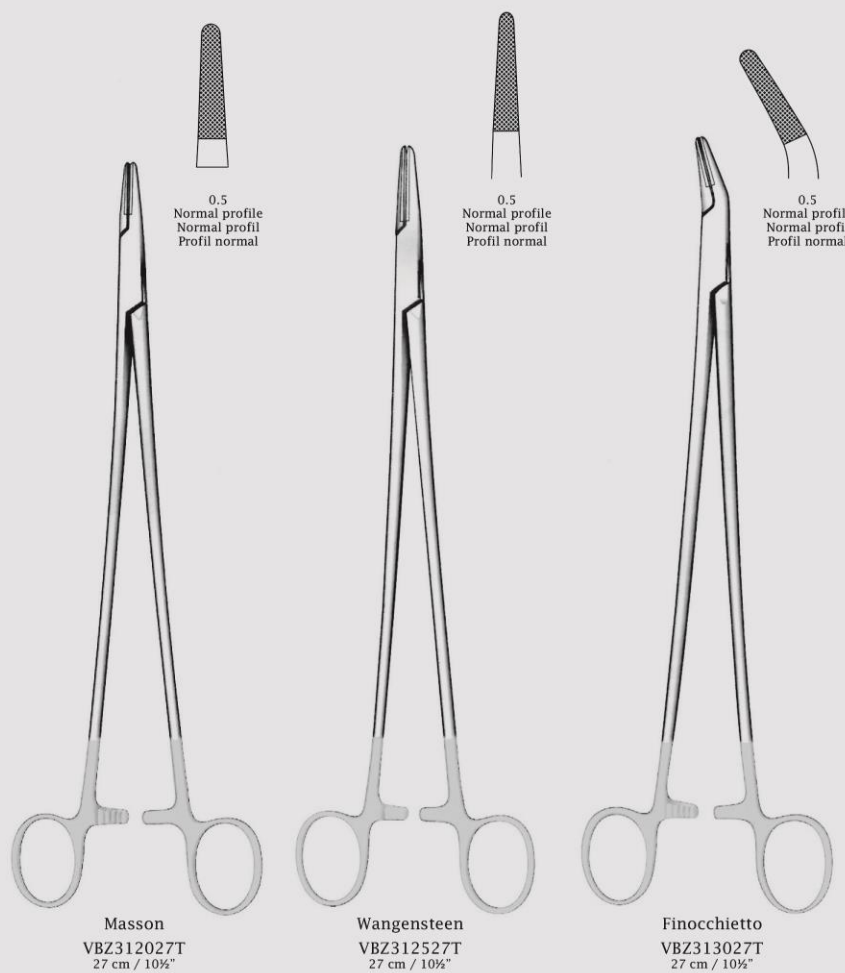
Bozemann

Heaney



Instruments with Tungsten Carbide Inserts
Tc Gold

Needle Holders
Needle Holders
Nadelhalter
Porta-agujas



سوز نگیرها



CE

SQS Certificate
ISO 9001:2000
ISO 13485:2003

207



Needle Holders
Needle Holders
Nadelhalter
Porta-agujas

سوز نگیرها



CE

SQS Certificate
ISO 9001:2000
ISO 13485:2003

208

Instruments with Tungsten Carbide Inserts

Tc Gold

Sarot
0.5
VBZ313518T 18 cm / 7"
VBZ313520T 20 cm / 8"
VBZ313526T 26 cm / 10 1/4"
Normal profile
Normal profil
Profil normal

Thomson Walker
0.5
Normal profile
Normal profil
Profil normal
VBZ314020T
20 cm / 8"

Naunton Morgan
0.5
Normal profile
Normal profil
Profil normal
VBZ314526T
26 cm / 10 1/4"

Olsen-Hegar
0.2
VBZ315512T
12 cm / 4 3/4"
Micro profile
Micro profil
Profil micro
0.4
VBZ077314T 14 cm / 5 1/2"
VBZ077316T 16 cm / 6 1/4"
VBZ077317T 17 cm / 6 3/4"
VBZ077319T 19 cm / 7 1/2"
Mini profile
Mini profil
Profil mini

Olsen-Hegar
0.4
VBZ315014T 14 cm / 5 1/2"
VBZ315016T 16 cm / 6 1/4"
VBZ315017T 17 cm / 6 3/4"
VBZ315019T 19 cm / 7 1/2"

Forester Gillies
0.4
VBZ316012T Right hand
VBZ316112T Left hand
12.5 cm / 5"
Serrated jaws

Gillies
0.4
VBZ077416T Right hand
VBZ208516T Left hand
16 cm / 6 3/4"
Mini profile
Mini Gillies
Special model
VBZ077415T Right hand
VBZ209010T Left hand
12 cm / 4 3/4"
Mini profile
VBZ316510T
10 cm / 4"
Micro profile



Instruments with Tungsten Carbide Inserts

Tc Gold

Needle Holders
Needle Holders
Nadelhalter
Porta-agujas

	 0.4 VBZ077714T 14 cm / 5½"	 0.5 VBZ077914T 14 cm / 5½"		 0.4 VBZ209520T 20 cm / 8"
	 0.4 VBZ077717T 17 cm / 6¾"	 0.5 VBZ077917T 17 cm / 6¾"		 0.4 VBZ209524T 24 cm / 9¾"
	 0.4 VBZ077720T 20 cm / 8"	 0.5 VBZ077920T 20 cm / 8"		
Mini profile Mini profil Profil mini		Normal profile Normal profil Profil normal		Mini profile Mini profil Profil mini
Mathieu		Mathieu - Standard		Mathieu

سوز نگیرها

	 0.5 Normal profile Normal profil Profil normal		 0.5 Normal profile Normal profil Profil normal		 0.5 VBZ079318T 18 cm / 7"
					 0.5 VBZ079320T 20 cm / 8"
					Normal profile Normal profil Profil normal
Lichtenberg VBZ078720T 20 cm / 8"		Toennis VBZ078518T 18 cm / 7" Elastic pattern		Langenbeck	



SQS Certificate
ISO 9001:2000
ISO 13485:2003





Needle Holders
Needle Holders
Nadelhalter
Porta-agujas

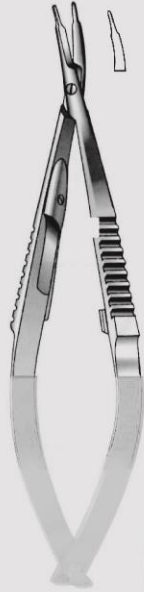
سوز نگیرها



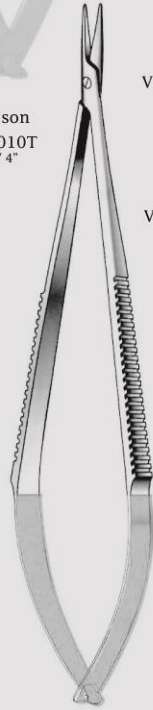
CE

SQS Certificate
ISO 9001:2000
ISO 13485:2003

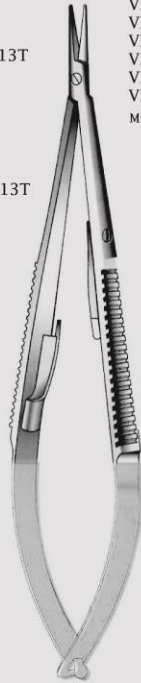
210



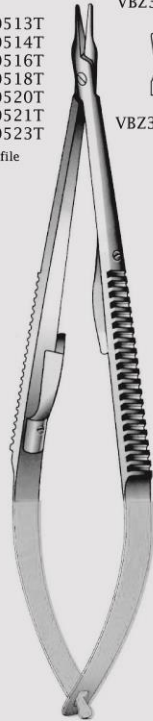
McPherson
VBZ317010T
10 cm / 4"



Castroviejo
13.5 cm / 5 1/2"
Without lock



Castroviejo
With lock



Castroviejo
13.5 cm / 5 1/2"
Extra delicate, with lock

Instruments with Tungsten Carbide Inserts
Tc Gold



VBZ072113T 13 cm / 5 1/4" VBZ072213T
VBZ072114T 14 cm / 5 1/2" VBZ072214T
VBZ072116T 16 cm / 6 1/4" VBZ072216T
VBZ072118T 18 cm / 7" VBZ072218T
VBZ072120T 20 cm / 8" VBZ072220T
VBZ072121T 21 cm / 8 1/2" VBZ072221T
VBZ072123T 23 cm / 9" VBZ072223T
Smooth Smooth, curved

VBZ317513T

VBZ317613T

VBZ317713T

VBZ317813T

VBZ210013T 13 cm / 5 1/4" VBZ210513T
VBZ210014T 14 cm / 5 1/2" VBZ210514T
VBZ210016T 16 cm / 6 1/4" VBZ210516T
VBZ210018T 18 cm / 7" VBZ210518T
VBZ210020T 20 cm / 8" VBZ210520T
VBZ210021T 21 cm / 8 1/2" VBZ210521T
VBZ210023T 23 cm / 9" VBZ210523T
Micro profile Micro profile

VBZ318013T

VBZ318113T



Instruments with Tungsten Carbide Inserts

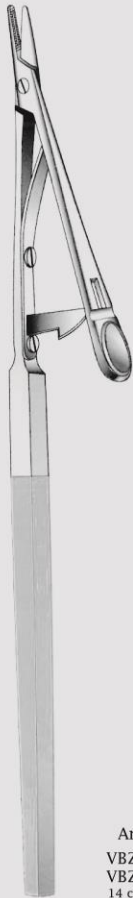
Tc Gold



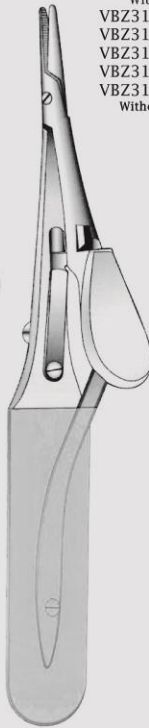
VBZ318513T	13cm/5¼"	VBZ319013T
VBZ318516T	16cm/6¼"	VBZ319016T
VBZ318518T	18cm/7"	VBZ319018T
VBZ318520T	20 cm / 8"	VBZ319020T
VBZ318523T	23 cm / 9"	VBZ319023T
With lock		With lock
VBZ318613T	13cm/5¼"	VBZ319113T
VBZ318616T	16cm/6¼"	VBZ319116T
VBZ318618T	18cm/7"	VBZ319118T
VBZ318620T	20 cm / 8"	VBZ319120T
VBZ318623T	23 cm / 9"	VBZ319123T
Without lock		Without lock



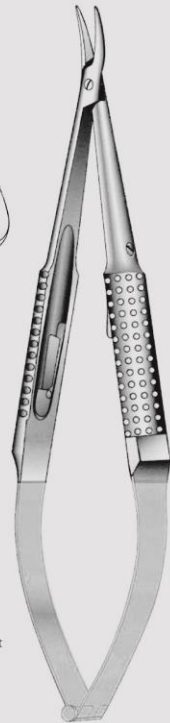
VBZ320513T	13 cm / 5¼"
VBZ320516T	16 cm / 6¼"
VBZ320518T	18 cm / 7"
VBZ320520T	20 cm / 8"
VBZ320523T	23 cm / 9"
With lock	



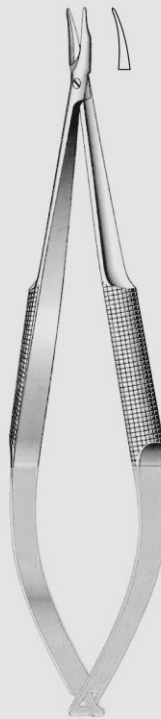
Stevens
VBZ321516T
16.5 cm / 6½"
With ratchet lock



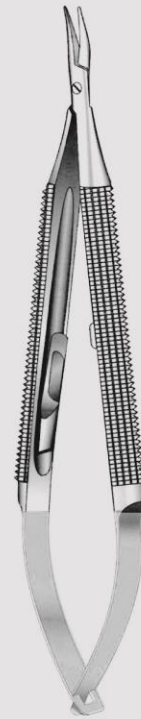
Arruga
VBZ321114T Straight
VBZ321014T Curved
14 cm / 5½"



Barraquer



Barraquer
VBZ320013T
13 cm / 5¼"



Barraquer-Troutman

Needle Holders
Needle Holders
Nadelhalter
Porta-agujas

سوز نگیرها



SQS Certificate
ISO 9001:2000
ISO 13485:2003





Needle Holders
Needle Holders
Nadelhalter
Porta-agujas

سوز نگیرها



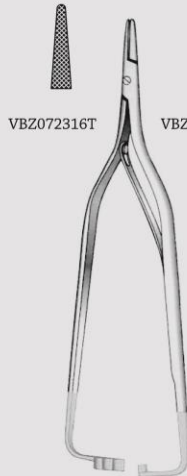
CE

SQS Certificate
ISO 9001:2000
ISO 13485:2003

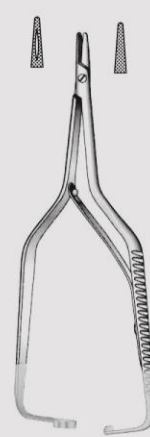
212



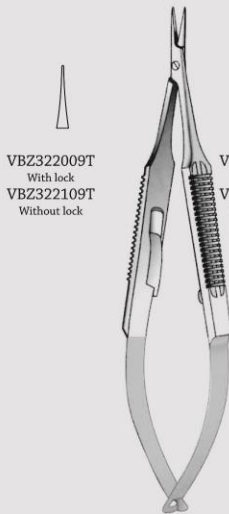
Kalt
VBZ211513T
13 cm / 5 1/4"
Standard model
Delicate jaws



Arruga
16 cm / 6 1/4"



Boynton
VBZ211012T
12.5 cm / 5"
Delicate



Castroviejo
9 cm / 3 1/2"



Castroviejo
VBZ323012T
12 cm / 4 3/4"

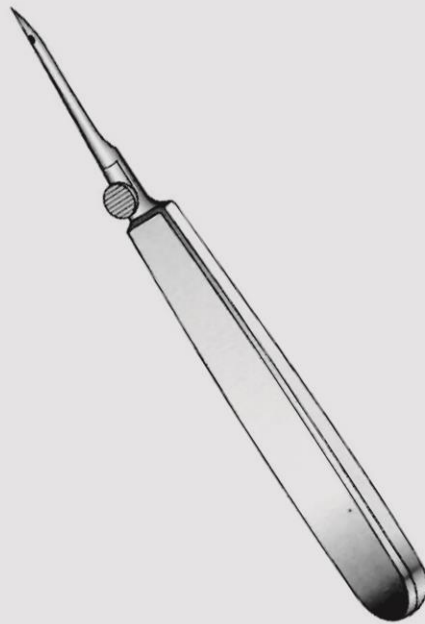


Castroviejo Barraquer
VBZ323512T
12 cm / 4 3/4"



Castroviejo
VBZ324013T
13 cm / 5"

DIAMOND SURGICAL
WWW.DIAMONDMED.IR INSTRUMENTS



VBZ

Suture Needles



CE

SQS Certificate
ISO 9001:2000
ISO 13485:2003

213



Sutures Needles
Reverdin Needles
Revrdin-Nadeln
Agujas de Reverdin

سوزن های روردن



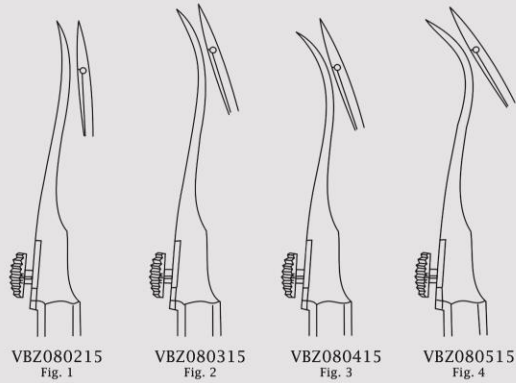
CE

SQS Certificate
ISO 9001:2000
ISO 13485:2003

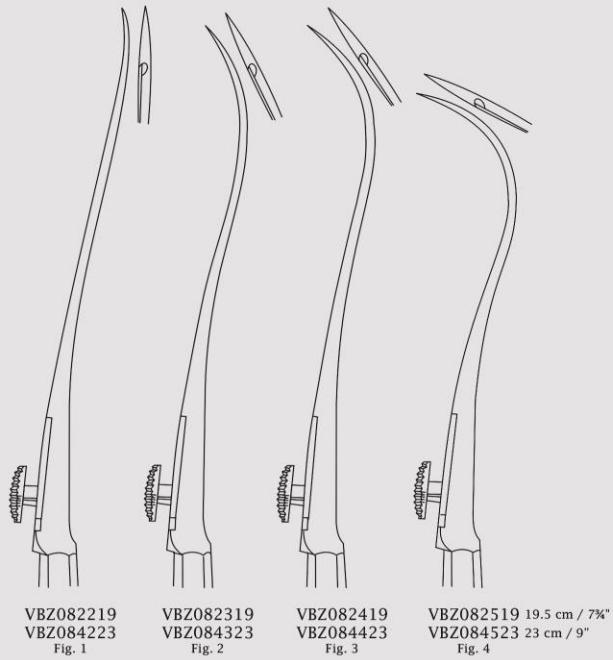
214



Reverdin
14 cm / 5½"
Short



Reverdin





Sutures Needles
Maxillary Awls
Uterkieferrahlen
Leznas Maxilares



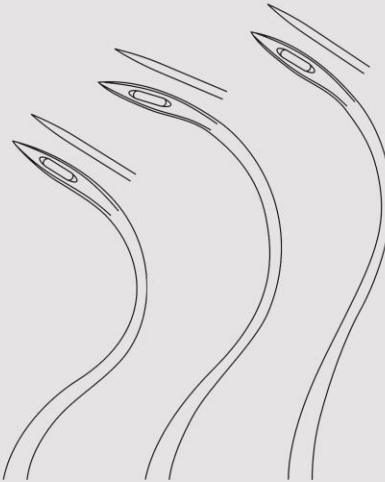
Obwegeser
VBZ400115
15 cm / 6"



Obwegeser
VBZ400517
17.5 cm / 7"



Obwegeser
VBZ401024
24 cm / 9½"



VBZ401520
20.5 cm / 8"

VBZ401621
21 cm / 8¼"

VBZ401721
21.5 cm / 8½"



Tessier

سوزن های آبوگیزر



CE

SQS Certificate
ISO 9001:2000
ISO 13485:2003

215



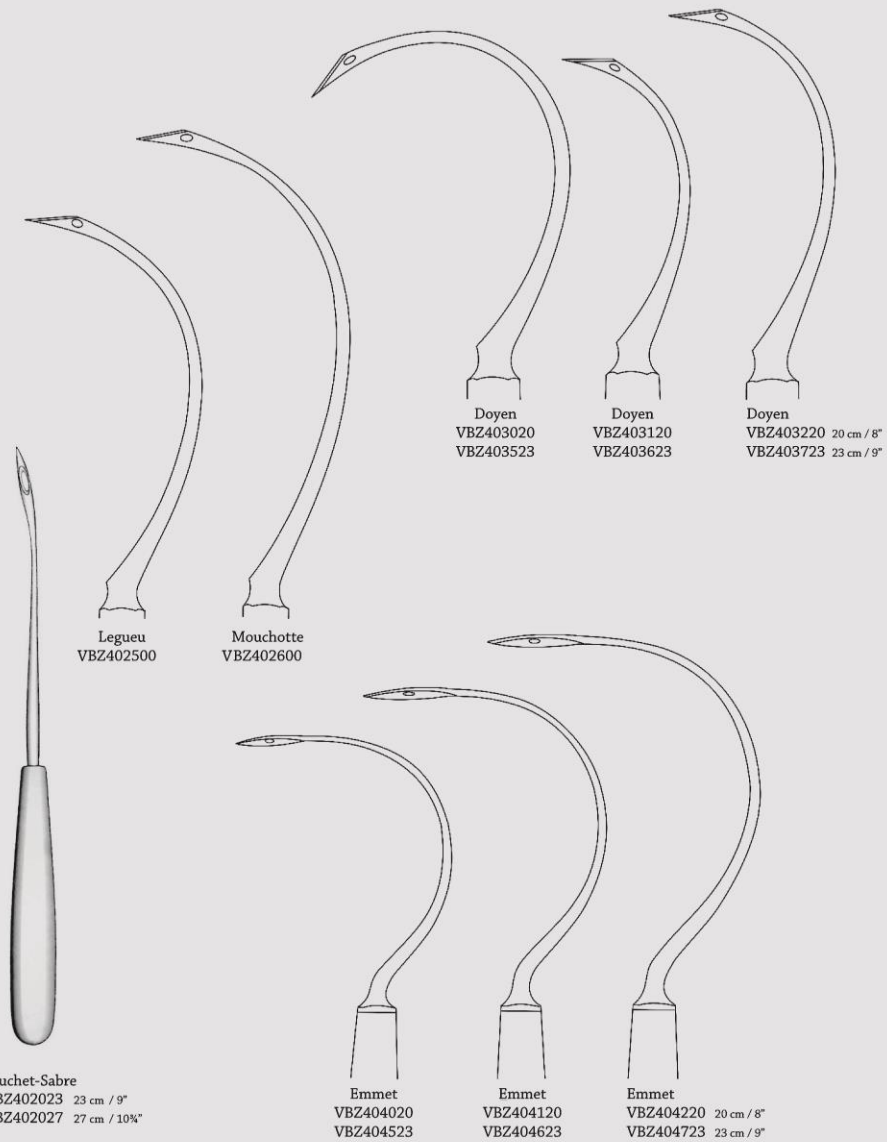
Sutures Needles
Reverdin Needles
Revrdin-Nadeln
Agujas de Reverdin

سوزن های آبوگیرز



SQS Certificate
ISO 9001:2000
ISO 13485:2003

216





Sutures Needles
Clip Applying Forceps
Wundklammerpinzetten
Pinzas aplicadores para
agrafes



Michel
VBZ405012
12 cm / 4 3/4"



Michel
VBZ405512
12 cm / 4 3/4"
1:2 Teeth



Wachenfeldt
VBZ406012
12.5 cm / 5"

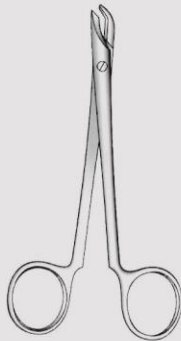


Hegenbarth
VBZ406512
12.5 cm / 5"

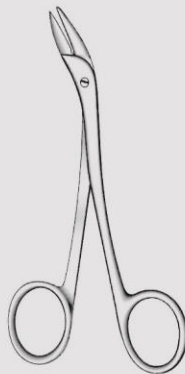


Wachenfeldt
VBZ407012
12.5 cm / 5"

پنس ها



Collin
VBZ407513
13 cm / 5"



Richter-Heath
VBZ408014
14 cm / 5 1/2"



Michel
VBZ408512
12 cm / 4 3/4"



Mod. Michel
VBZ409012
12 cm / 4 3/4"



CE

SQS Certificate
ISO 9001:2000
ISO 13485:2003

217



Sutures Needles
Clip Applying Forceps
Wundklammerpinzetten
Pinzas aplicadores para agujas

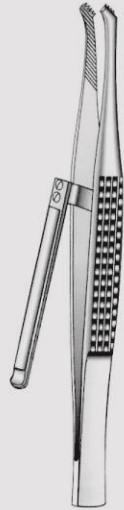
پنس ها



CE

SQS Certificate
ISO 9001:2000
ISO 13485:2003

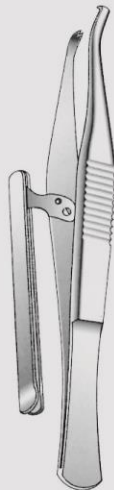
218



Childe
VBZ409518
18 cm / 7"



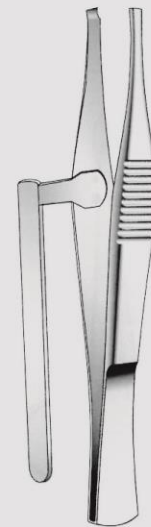
Michel
VBZ410013 13 cm / 5"
VBZ410016 16 cm / 6 1/4"



Pauchet
VBZ410500
16 cm / 6 1/4"



Martinaud
VBZ411000
14 cm / 5 1/2"



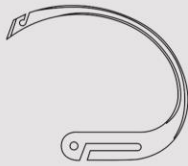
Michel
VBZ411500
14 cm / 5 1/2"



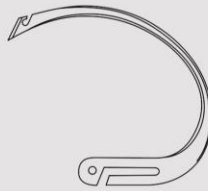
Suture Needles
Reverdin Needles
Reverdin Nadeln
Agujas de Reverdin



VBZ412500
Fig. 1



VBZ412600
Fig. 2



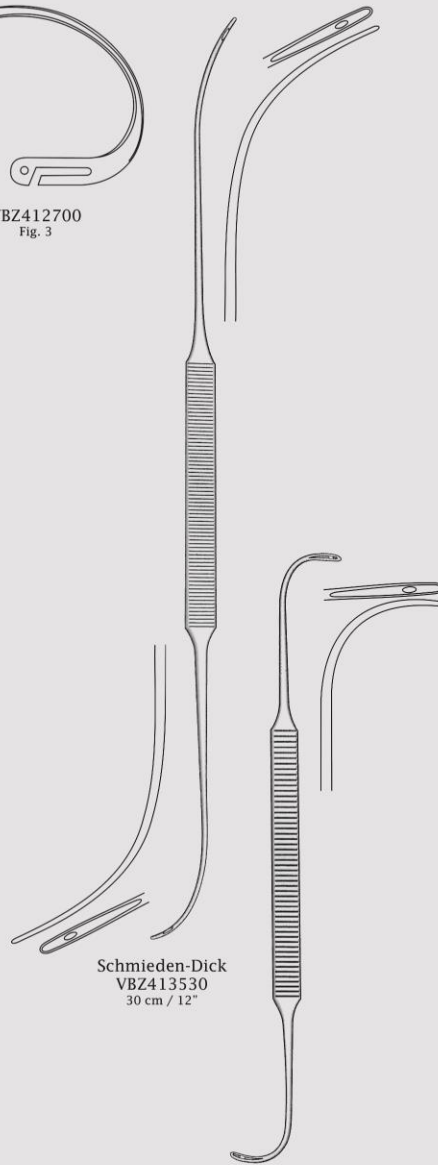
VBZ412700
Fig. 3



Young-Hryntschank
VBZ412024
24 cm / 9 1/2"
Complete with one needle no. 1



Young-Millin
VBZ413020
20 cm / 8"
With 1 needle



Schmieden-Dick
VBZ413530
30 cm / 12"

Schmieden
VBZ414024
24 cm / 9 1/2"

سوزن های روردين



CE

SQS Certificate
ISO 9001:2000
ISO 13485:2003

219



Suture Needles
Ligature Needles
Unterbindungsnadeln
Agujas para ligaduras

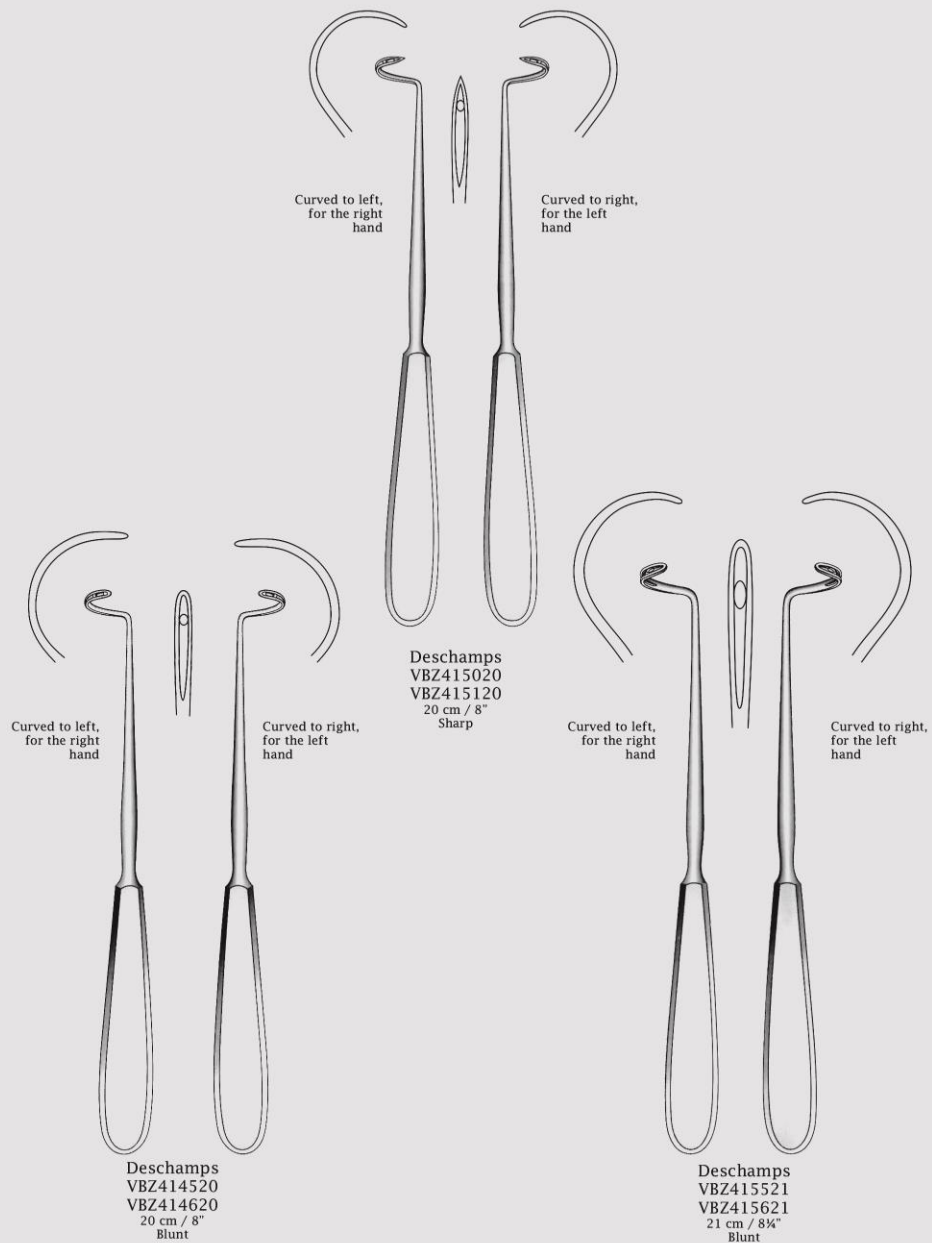
سوزن های لیگاتور



CE

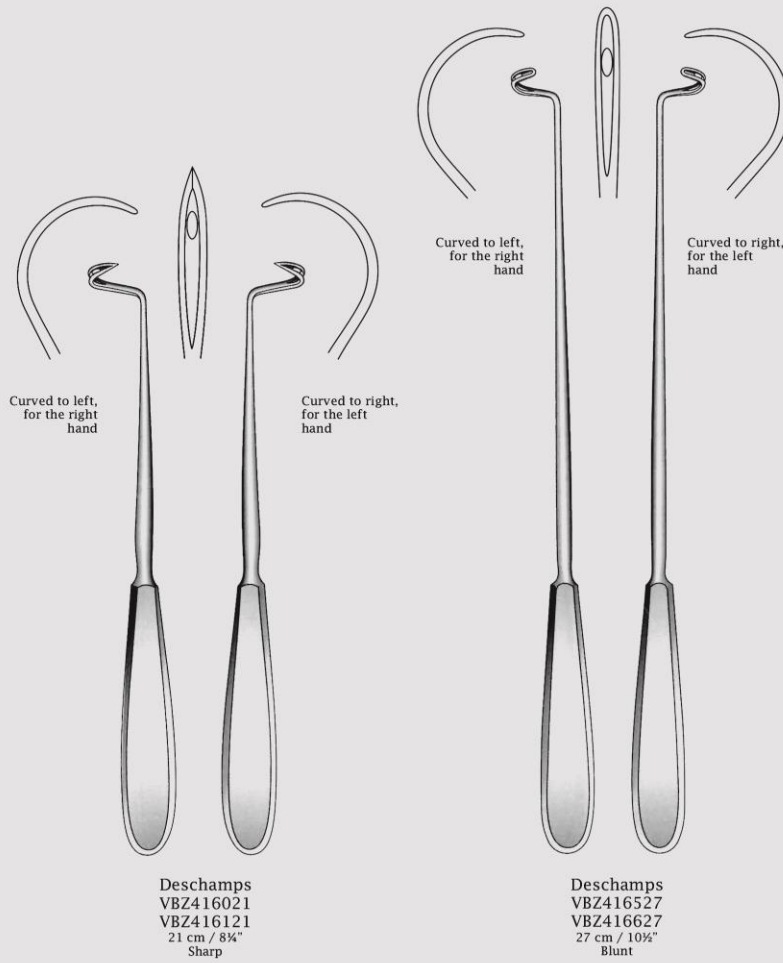
SQS Certificate
ISO 9001:2000
ISO 13485:2003

220





Suture Needles
Ligature Needles
Unterbindungsnadeln
Agujas para ligaduras



سوزن های لیگاتور



CE

SQS Certificate
ISO 9001:2000
ISO 13485:2003





Suture Needles
Ligature Needles
Unterbindungsnadeln
Agujas para ligaduras

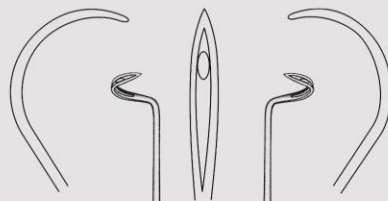
سوزن های لیگاتور



CE

SQS Certificate
ISO 9001:2000
ISO 13485:2003

222

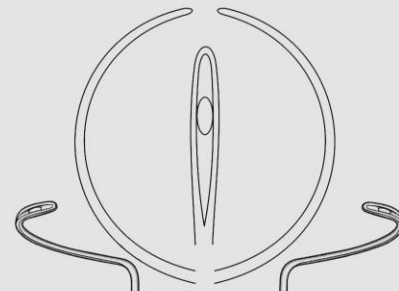


Curved to left,
for the right
hand

Curved to right,
for the left
hand



Deschamps
VBZ417027
VBZ417127
27 cm / 10 1/2"
Sharp



Curved to left,
for the right
hand

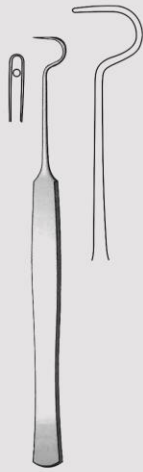
Curved to right,
for the left
hand



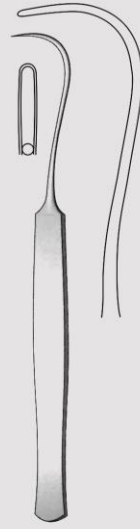
Deschamps
VBZ417528
VBZ417628
28 cm / 11"
Blunt



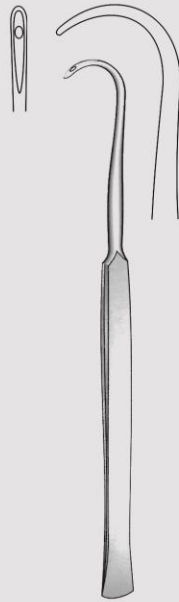
Suture Needles
Ligature Needles
Unterbindungsnadeln
Agujas para ligaduras



VBZ418015
15 cm / 6"



Ssyme
VBZ418517
17 cm / 6 3/4"



Cooper
VBZ419019
19 cm / 7 1/2"



Cooper
VBZ419520
20.5 cm / 8"

سوزن های لیگاتور



CE

SQS Certificate
ISO 9001:2000
ISO 13485:2003

223



Suture Needles
Ligature Needles
Unterbindungsnadeln
Agujas para ligaduras

سوزن های لیگاتور



CE

SQS Certificate
ISO 9001:2000
ISO 13485:2003

224



VBZ421024
Full curve

VBZ421124
Half curve



Kocher
VBZ420020
20.5 cm / 8"



Malleable
VBZ420523
23 cm / 9"



Brunner
24 cm / 9½"



Suture Needles
Guiding Probes
Führungsonden
Sondas para guia



VBZ421520
20 cm / 8"



Koenig
VBZ422019
19.5 cm / 7 1/2"



Koenig
VBZ422520
20 cm / 8"



Schmieden
VBZ423018
18.5 cm / 7 1/4"

پروپ ها



CE

SQS Certificate
ISO 9001:2000
ISO 13485:2003

225



Suture Needles
Guiding Probes
Führungsonden
Sondas para guia

پروپ ها



CE

SQS Certificate
ISO 9001:2000
ISO 13485:2003

226



11 mm



kocher
VBZ423515
15 cm / 6"



12 mm



Kocher
VBZ424017
17 cm / 6 3/4"



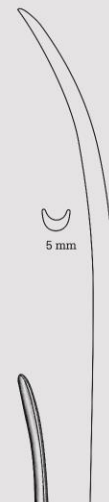
5 mm



Payr
VBZ424519
19.5 cm / 7 1/2"



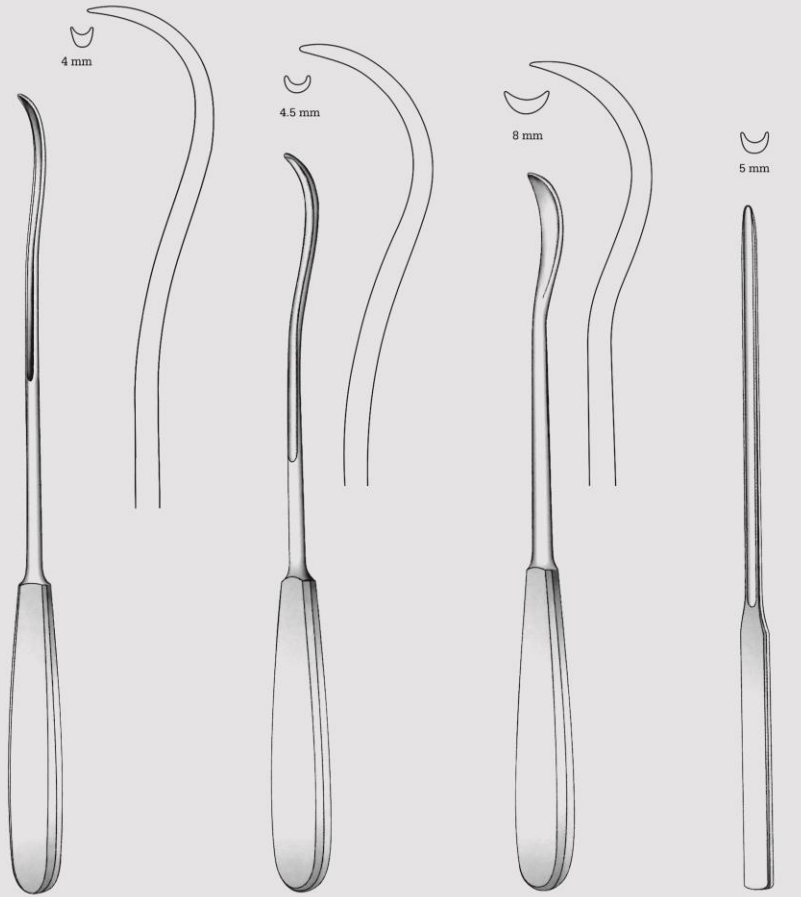
5 mm



Payr
VBZ425022
22.5 cm / 9"



Suture Needles
Guiding Probes
Führungsonden
Sondas para guia



VBZ425528
28 cm / 11"

Kirschner
VBZ426025
25.5 cm / 10"

Brunner
VBZ426524
24.5 cm / 9 3/4"

VBZ427024
24 cm / 9 1/2"

پروپ ها



CE

SQS Certificate
ISO 9001:2000
ISO 13485:2003

227



Suture Needles

Ligature Conductors, Knot
Tiers, Ligature Catcher
Führungshohlsonden,
Fadenknoter, Fanger
Sondas Conductoras,
Tuerce-hilos

لیگاتورها



CE

SQS Certificate
ISO 9001:2000
ISO 13485:2003

228



Mod. Wiener
VBZ427523
23.5 cm / 9 1/4"
Suture hook

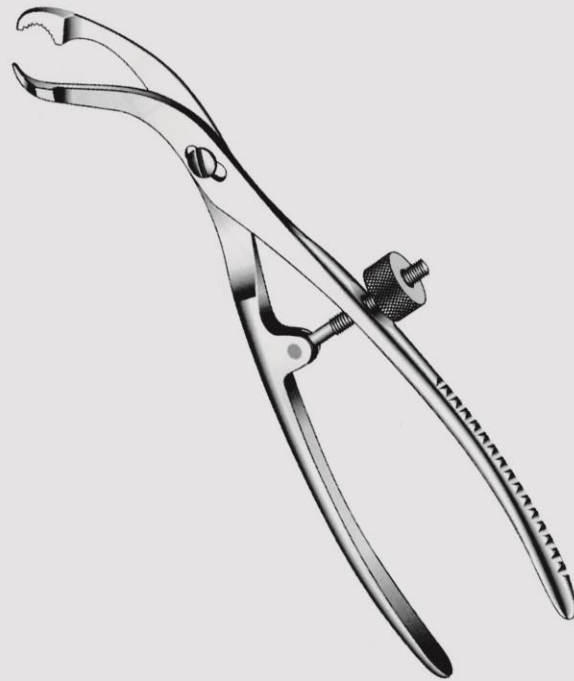


VBZ428023
23 cm / 9"
Ligature catcher



Caspar
VBZ428523
23 cm / 9"
Ligature adjuster

DIAMOND SURGICAL
WWW.DIAMONDMED.IR INSTRUMENTS



VBC
Orthopedic



CE

SQS Certificate
ISO 9001:2000
ISO 13485:2003

229



Orthopedic
Plaster-of-Paris Knives
Gipsmesser
Chuc hillos

ارتوپدی چاقوها



CE

SQS Certificate
ISO 9001:2000
ISO 13485:2003

230



Esmarch
VBA300118
18 cm / 7"



Reiner
VBA300518
18.5 cm / 7 1/4"



Hopkins
VBA301020
20 cm / 8"

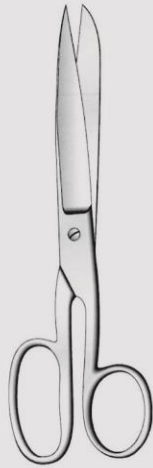


VBA301521
21 cm / 8 1/4"

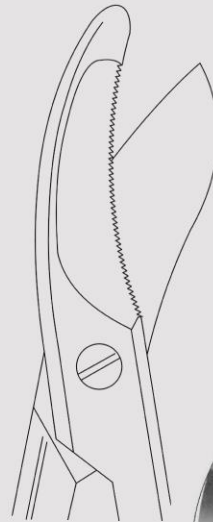
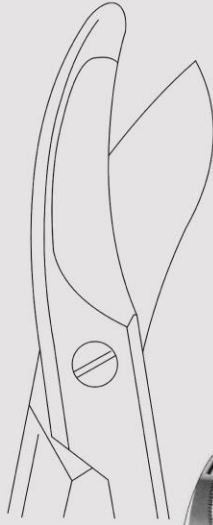
www.Diamondmed.ir



Orthopedic
Bandage Scissors
Verbandscheren
Tijeras Para Vendajes



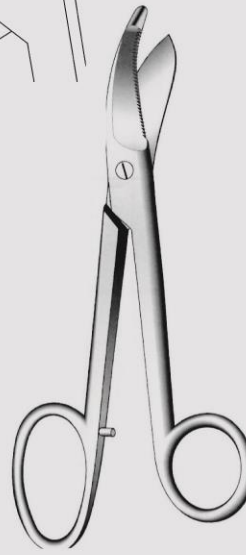
Smith
(Mod. USA)
VBA302020
20 cm / 8"



Brun's
VBA039824 Plain
23.5 cm / 9 1/4"
VBA202524T Serrated
24 cm / 9 1/2"
Open shanks with pin



Brun's
VBA302524
23.5 cm / 9 1/4"
Closed shanks, serrated



Brun's
VBA303024
24 cm / 9 1/2"
Open shanks with pin, serrated

ارتوپدی
قیچی ها



CE

SQS Certificate
ISO 9001:2000
ISO 13485:2003

231



Orthopedic
Bandage Scissors
Verbandscheren
Tijeras para Vendajes

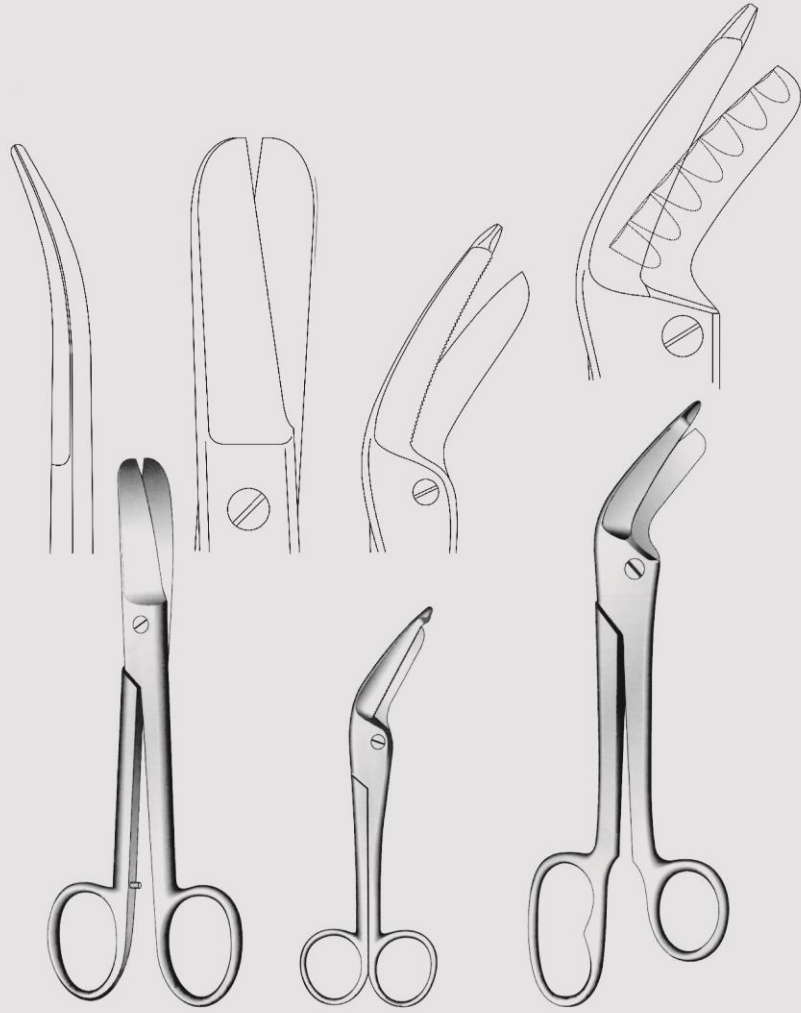
ارتوپدی
قیچی ها



CE

SQS Certificate
ISO 9001:2000
ISO 13485:2003

232



Lorenz
VBA303523
23 cm / 9"

Excentric
VBA304016 16cm / 6¼"
VBA304019 19cm / 7½"

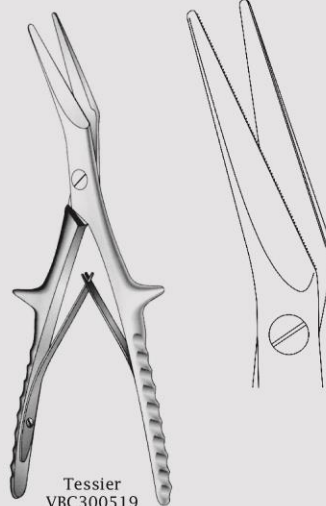
Tornado
VBA304524
24 cm / 9½"
Undulated cutting edge



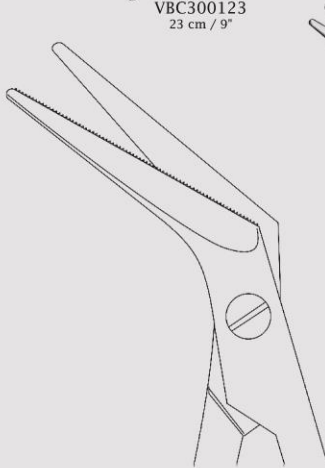
Orthopedic
Bone Cutting Forceps
Knochenschneidezangen
Pinzas Para Cortar Huesos



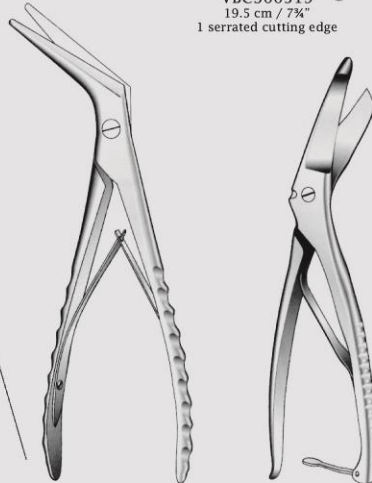
Seutin
VBC300123
23 cm / 9"



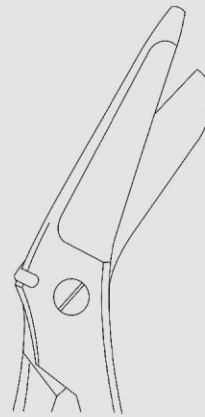
Tessler
VBC300519
19.5 cm / 7 3/4"
1 serrated cutting edge



Tessler
VBC301019
19 cm / 7 1/2"
1 serrated cutting edge



Universal
VBC301520
20 cm / 8"



ارتوپدی
قیچی ها



CE

SQS Certificate
ISO 9001:2000
ISO 13485:2003

233



Orthopedic
Plaster Cast Spreaders
Gipsspreizer
Separadores para yeso

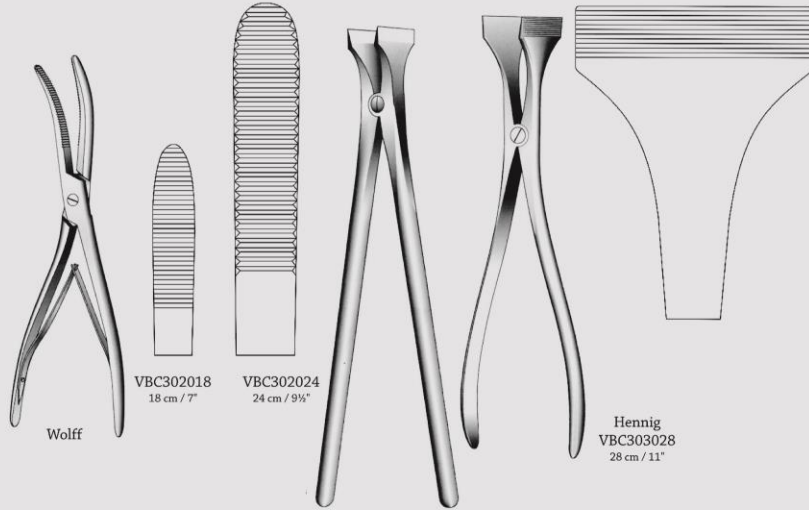
ارتوپدی
گج بازکن



CE

SQS Certificate
ISO 9001:2000
ISO 13485:2003

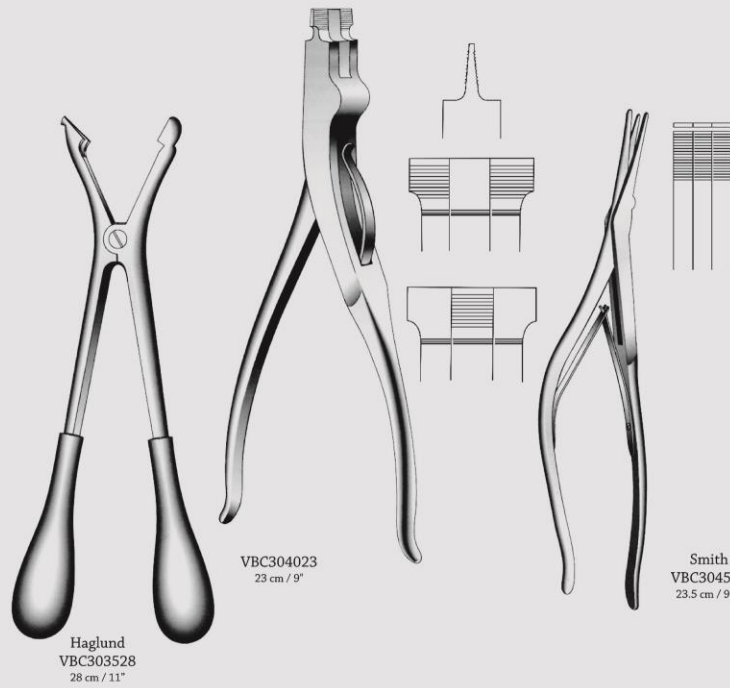
234



Wolff
VBC302018
18 cm / 7"

Beeson
VBC302530
30 cm / 12"

Hennig
VBC303028
28 cm / 11"



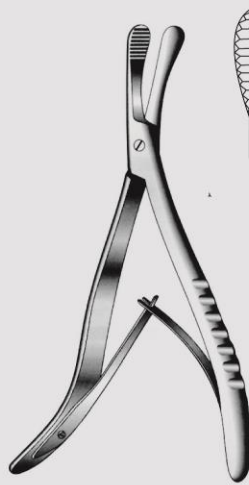
Haglund
VBC303528
28 cm / 11"

Beeson
VBC304023
23 cm / 9"

Smith
VBC304523
23.5 cm / 9 1/4"



Orthopedic
Plaster of Paris Shears
Gipsscheren
Cizallas para vendajes enyesados



Masson
VBC305018
18 cm / 7"
Pediatric cast breaker
deep serrated tips



For lightweight cast
breaking and trimming



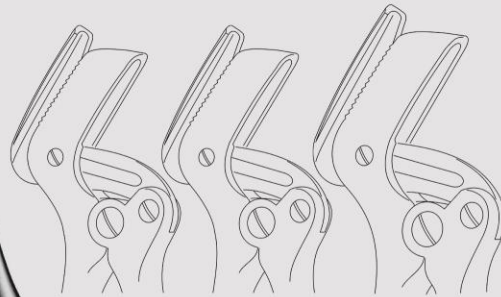
Stille
VBC305524
24 cm / 9 1/2"



Stille-Mini
VBC306020
Blade with reinforced back
VBC306120
Blade without reinforced back
20 cm / 8"



Stille



VBC306523
Blade with reinforced back
VBC306623
Blade without reinforced back
23 cm / 9"

VBC306526
Blade with reinforced back
VBC306626
Blade without reinforced back
26 cm / 10 1/4"

VBC306537
Blade with reinforced back
VBC306637
Blade without reinforced back
37 cm / 14 1/2"

ارتوپدی
قیچی ها



CE

SQS Certificate
ISO 9001:2000
ISO 13485:2003

235



Orthopedic
Mallets
Hammer
Martillos Y Mazos

ارتوپدی چکش ها



CE

SQS Certificate
ISO 9001:2000
ISO 13485:2003

236



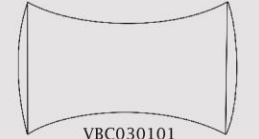
VBC031701
16.5 cm / 6 1/2"
140 gm / 5 oz, 20 mm Ø



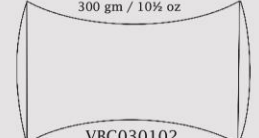
Collin
VBC030920
20 cm / 8"
220 gm / 7 3/4 oz, 30 mm Ø



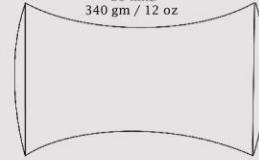
Williger
24 cm / 9 1/2"



VBC030101
26 mm
300 gm / 10 3/4 oz



VBC030102
28 mm
340 gm / 12 oz



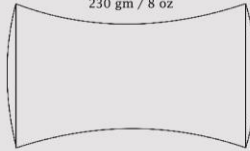
VBC030103
30 mm Ø
400 gm / 14 oz



Lucae
19 cm / 7 1/2"



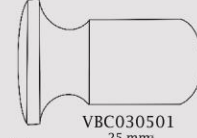
VBC031501
19 mm
230 gm / 8 oz



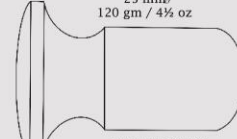
VBC031502
25 mm Ø
260 gm / 9 oz



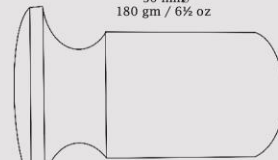
Doyen
21 cm / 8 3/4"



VBC030501
25 mm
120 gm / 4 1/4 oz



VBC030502
30 mm
180 gm / 6 1/2 oz



VBC030503
35 mm Ø
260 gm / 9 oz



**Orthopedic
Mallets
Hammer
Martillos Y Mazos**



Mead
320 gm, 26 mm
VBC307017
Solid
VBC307117
17 cm / 6 3/4"
Ferrozell faces only, pair

Partsch
22 mm
VBC307518
18 cm / 7"
200 gm
VBC307616
16 cm / 6 1/4"
165 gm
VBC307718
18 cm / 7"
220 gm

Heath
VBC308018
18.5 cm / 7 1/4"
700 gm, 40 mm
Cooper filled head

Autoclavable to
250°F (121°C)

Mallet Lightweight
19 cm / 7 1/2"
25 mm
VBC308519
140 gm
VBC308619
Two replaceable nylon caps
Total weight: 7 oz.
Head weight: 4 oz



Autoclavable to
250°F (121°C)

Combination Mallet
19 cm / 7 1/2"
VBC309019
Total weight: 9 oz
Head weight: 5 oz
26 mm
VBC309119
Total weight: 12 oz
Head weight: 8 oz
38 mm
One side nylon cap

VBC309500
1000 gm
VBC309600
700 gm
VBC309700
500 gm

Aluminium handle
VBC310000
600 gm, 22 oz
Heavy
VBC310100
300 gm, 11 oz

Cottle
VBC310519
19 cm / 7 1/2"
240 gm, 30 mm

ارتوپدی چکش ها



SQS Certificate
ISO 9001:2000
ISO 13485:2003





Orthopedic
Mallets
Hammer
Martillos Y Mazos

ارتوپدی چکش ها



CE

SQS Certificate
ISO 9001:2000
ISO 13485:2003

238



Gerzog
VBC311018
18 cm / 7"
250 gm



Kirk
VBC311519
19 cm / 7½"
750 gm



Ombredanne
VBC312024
24 cm / 9½"
550 gm, 40 mm



Bergmann
VBC312524
24.5 cm / 9¾"
300 gm, 45 mm



Bergmann
VBC313023
23.5 cm / 9¼"
300 gm, 30 mm



Wagner
VBC313523
23.5 cm / 9¼"
35 mm



Metal head
VBC314000
230 gm, 35 mm



Plastic head
VBC314100
32 gm, 35 mm



Quisling
VBC314500



VBC315023
23.5 cm / 9¼"



Orthopedic
Mallets
Hammer
Martillos y Mazos

ارتوپدی چکش ها



VBC315526 450 gm
VBC315626 900 gm
26 cm / 10 1/2"



VBC316026
26 cm / 10 1/2"
510 gm / 18 oz
30 mm ø



VBC316500
Head weight 550 gm
Total weight 750 gm
40 mm ø



VBC317000
Head weight 350 gm
Total weight 550 gm
35 mm ø



VBC317500
Head weight 300 gm
30 mm ø



VBC318000
Head weight 300 gm
Total weight 500 gm
30 mm ø



VBC318500
Medium size hammer
Full aluminum
Total weight 200 gm



VBC319000
Small hammer aluminum handle
with stainless steel head
with rubber side (changeable)
Total weight 125 gm



CE

SQS Certificate
ISO 9001:2000
ISO 13485:2003

239



Orthopedic
Bone Files
knochenfeile
Lima para Huesos

ارتوپدی
بن فایل

ایزاد جراحی
دیامند

CE

SQS Certificate
ISO 9001:2000
ISO 13485:2003

240



15.5 cm / 6"

VBC029902
2 mm Ø

VBC029903
3 mm Ø

VBC029904
4 mm Ø

VBC029905
5 mm Ø

VBC029906
6 mm Ø

VBC029908
8 mm Ø

VBC029910
10 mm Ø



Kienny
VBC319517
17.5 cm / 7"



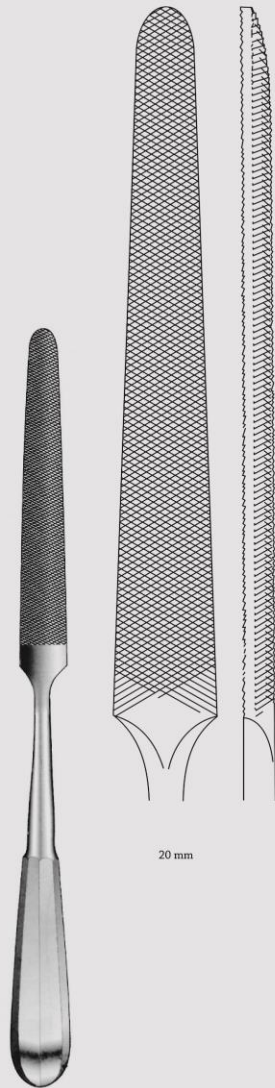
Trillat
VBC320120 9 x 9 mm
VBC320220 9 x 19 mm
20 cm / 8"



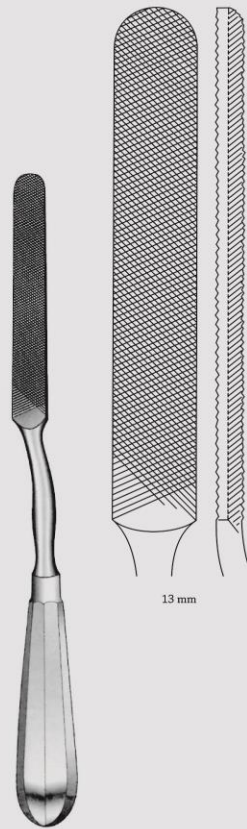
Cylindriques Double
VBC320516 8 x 15 mm Ø
16 cm / 6 1/4"
VBC321021 6 x 8 mm Ø
VBC321121 10 x 12 mm Ø
21 cm / 8 1/4"



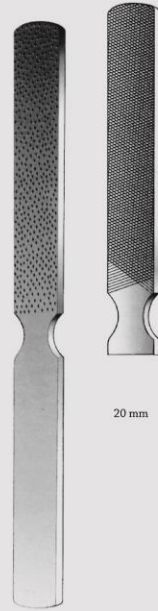
Orthopedic
Bone Files
Knochenfeile
Lima para Huesos



VBC321528
28 cm / 11"



VBC322024
24.5 cm / 9 3/4"



VBC322522
22 cm / 8 3/4"

20 mm

ارتوپدی
رِسپ (سوهان)



CE

SQS Certificate
ISO 9001:2000
ISO 13485:2003

241



Orthopedic
Bone Files, Bone Levers
Knochenfeile, Knochenhebel
Lima para Huesos, Elevadores para hueso

ارتوپدی - رسپ
(سوهان)



CE

SQS Certificate
ISO 9001:2000
ISO 13485:2003

242



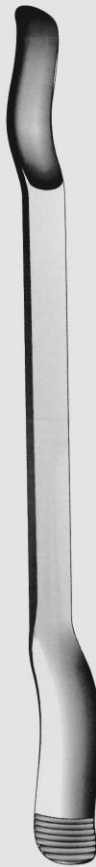
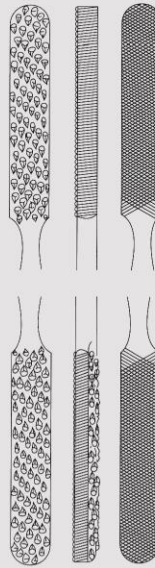
Putti
VBC323030
30 cm / 12"



Putti
VBC323527
27 cm / 10 1/2"



Fomon
VBC324021
21 cm / 8 1/4"
Double ended, fine and
coarse teeth 4-side, convex and flat
blades 8 mm width



Murphy-Lane
VBC324530
30 cm / 12"
Bone skid



Orthopedic
Nasal Rasp, Bone Files
Nasenraspeln, Knochenfeile
Escofinasanasanes, Lima Para Huesos



Trochlear
VBC325017
17 cm / 6 1/2"
Stainless steel



Maltz Improved
VBC325521
21 cm / 8 1/4"
Double ended, forward and
backward cutting, 8 mm width



Aufricht
21 cm / 8 1/4"



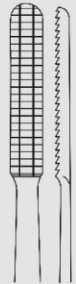
VBC326021
Single ended
forward cutting
9 mm width



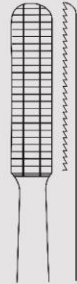
VBC326121
Single ended
backward cutting
9 mm width



Maltz
18 cm / 7"
Single ended
10 mm width



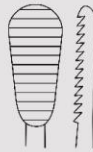
VBC326518
34 x 7 mm
Backward cutting



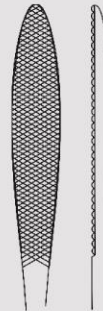
VBC326618
34 x 7 mm
Forward cutting



Excision Arthroplasty
VBC327017
17 cm / 6 1/2"
Stainless steel



Joseph
VBC327516
16 cm / 6 1/4"
Single ended, 8 mm at wide
point, fine cross serrations



CE

SQS Certificate
ISO 9001:2000
ISO 13485:2003

243



Orthopedic
Bone Files
Knochenfeile
Lima Para Huesos

ارتوپدی - رسپ
(سوهان)



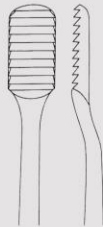
CE

SQS Certificate
ISO 9001:2000
ISO 13485:2003

244



Lewis Rasp
19 cm / 7½"



VBC328019
Fine, single ended
8 mm width



VBC328119
Coarse, single ended
8 mm width
plain serrations



Cottle Rasp
VBC328520
20.5 cm / 8"
Single ended, backward cutting
9 mm width
plain serrations



Miller-Colburn
VBC059101
18 cm / 7"
Double ended, plain serrations



Miller-Colburn
VBC329018
18 cm / 7"
Double ended, 5 mm width



Cross serrations
Plain serrations



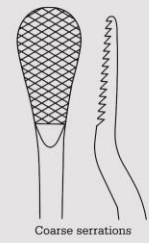
Miller-Colburn
VBC329518
18 cm / 7"
Double ended, cross serrations



7 mm
5 mm



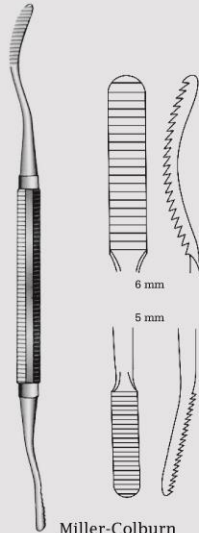
Miller-Colburn
VBC330121
21.5 cm / 8½"
Double ended, 13 mm width
Cross serrations, for rapid shaping of bone



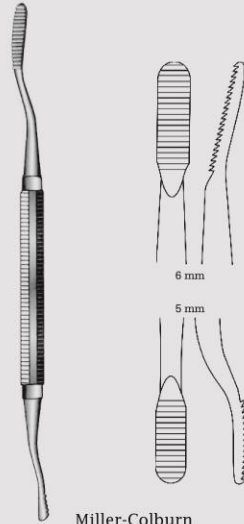
Coarse serrations
Fine serrations



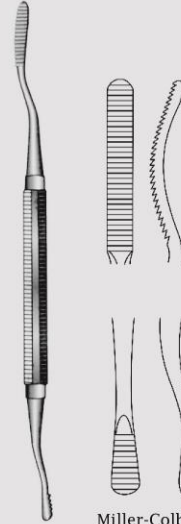
Orthopedic
Bone Files
Knochenfeile
Lima Para Huesos



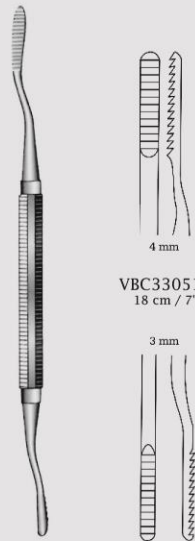
Miller-Colburn
VBC059102
18.5 cm / 7 1/4"
Double ended, plain serrations



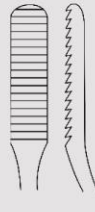
Miller-Colburn
VBC059104
18 cm / 7"
Double ended, plain serrations



Miller-Colburn
VBC059103
18 cm / 7"
Double ended, 5 mm width,
plain serrations

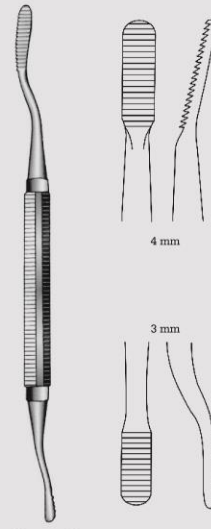
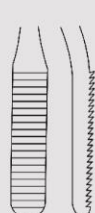


Polokoff Rasp
Double ended, plain serrations



VBC330518
18 cm / 7"

VBC330521
21.5 cm / 8 1/2"
6 mm width



Miller-Colburn
VBC331018
18 cm / 7"
Double ended

ارتوپدی - رسپ
(سوهان)



CE

SQS Certificate
ISO 9001:2000
ISO 13485:2003

245



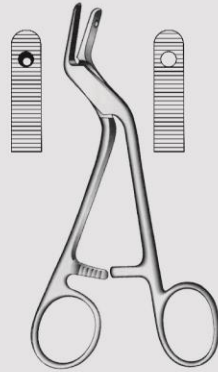
Orthopedic
Bone Drills, Reamers & Wire Saws
Bohrinstrumente, Perleme und Drahtsagen
Instrumental Para Perforar, Escariador Y Sierras de hilo

ارتوپدی

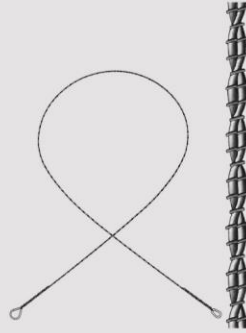


CE
SQS Certificate
ISO 9001:2000
ISO 13485:2003

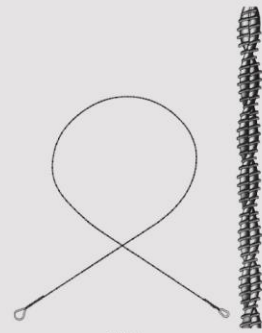
246



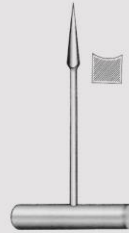
Adson
VBC331515
15 cm / 6"
Drill guide



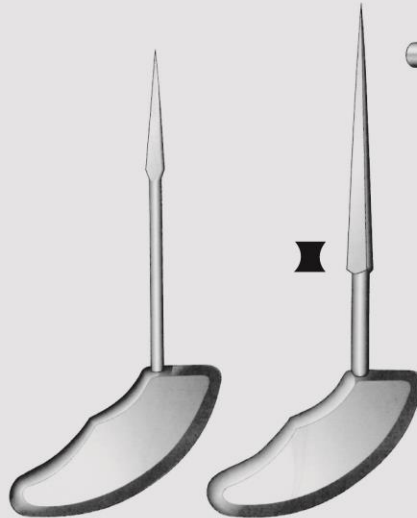
Olivecrona
VBC334530 30 cm / 12"
VBC334540 40 cm / 16"
VBC334550 50 cm / 20"
VBC334570 70 cm / 28"



Gigli
VBC335030 30 cm / 12"
VBC335040 40 cm / 16"
VBC335050 50 cm / 20"
VBC335150 50 cm / 20"
Fine, 6 wires twisted



VBC332014
14 cm / 5 1/2"



Perthes
VBC333518
18 cm / 7"

Perthes
VBC334021
21 cm / 8 1/4"



VBC332514
14 cm / 5 1/2"



VBC333030
30 cm / 12"
Straight ball spike

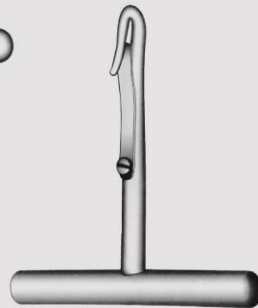


Orthopedic

Amputating, Resection
Saws & Handles
Amputation,
Resektionssagen und griffe
Ampvtacion, Sierras Para
Reseccion Y Mangos



Gigli
VBC335500
Handle



Gigli
VBC336000
Handle with lock



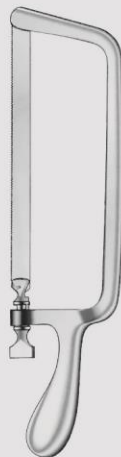
Engel
VBC336500



Lindemann
VBC337020
20 cm / 8"



Langenbeck
VBC337523
23 cm / 9"



Charriere
VBC338035
35 cm / 14"



Charriere
VBC338527 27cm / 10½"
VBC338530 30cm / 12"
VBC338534 34cm / 13½"



Satterlee
VBC339030
30 cm / 12"
Blade 23 cm / 9"

ارتوپدی اړه ها



SQS Certificate
ISO 9001:2000
ISO 13485:2003





Orthopedic
Retractor, Amputation
and Resection Saws
Wundhaken, Amputation-
Und Resektionssagen
Separadores, Sierras Para
Ampvtacion Y Reseccion

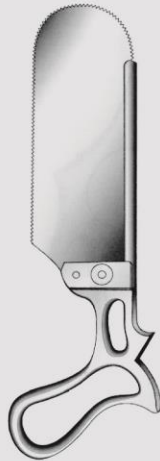
ارتوپدی
اره ها



CE

SQS Certificate
ISO 9001:2000
ISO 13485:2003

248



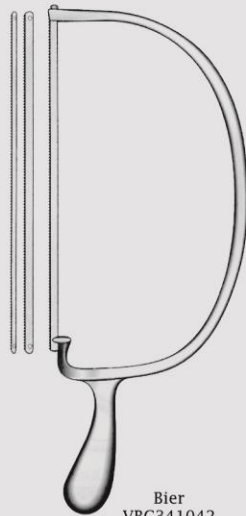
VBC339530
30 cm / 11 3/4"
Blade 20 cm
Post mortem saw



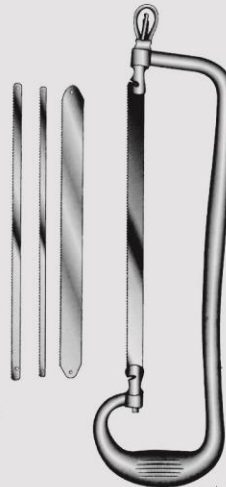
Butcher
VBC340100
Blade 45 cm
Post mortem saw



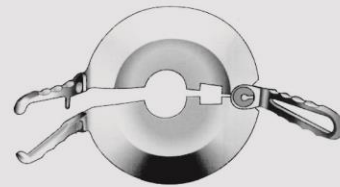
VBC340500
Blade 40 cm
Post mortem saw



Bier
VBC341042
42 cm / 16 1/2"
Length of blade 27 cm / 10 3/4"
Complete with one saw blade each
4 mm, 6 mm, 8 mm



Rust
VBC341539
39 cm / 15 1/2"
Length of blade
Complete with one saw blade
each 8 mm, 12 mm



Percy
VBC342000



Orthopedic
Hand Drills
Handbohrapparate
Perforadores De Mano



Hudson
VBC343500
Extension piece



VBC343600
9 mm Ø
Conical burr



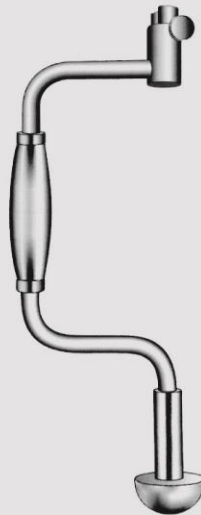
VBC343700
14 mm Ø
Conical burr



VBC343800
16 mm Ø
Spherical burr



VBC343900
22 mm Ø
Spherical burr



Hudson
27 cm / 10 3/4"
VBC342527
Complete set with Stainless steel handles
VBC342627
Complete set with Ferrosell handles
VBC342727
Complete set with Teflon handles



VBC344000
14 mm Ø
Flat trephine



VBC344100
2 mm Ø
Twist drill



VBC344200
13 mm Ø
Burr



VBC344300
16 mm Ø
Burr

Hudson
27 cm / 10 3/4"
VBC343027
Brace only with Stainless steel handles
VBC343127
Brace only with Ferrosell handles
VBC343227
Brace only with Teflon handles

ارتوپدی
تروپان



CE

SQS Certificate
ISO 9001:2000
ISO 13485:2003

249

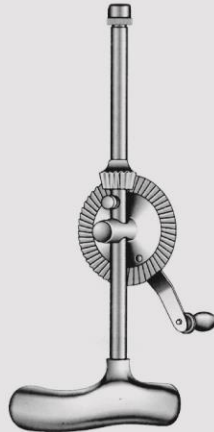


Orthopedic
Hand Drills
Handbohrapparate
Perforadores De Mano

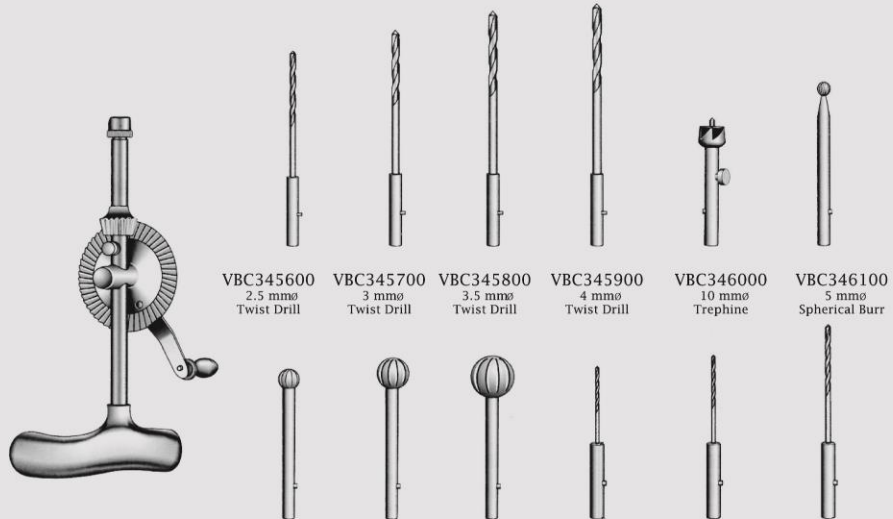
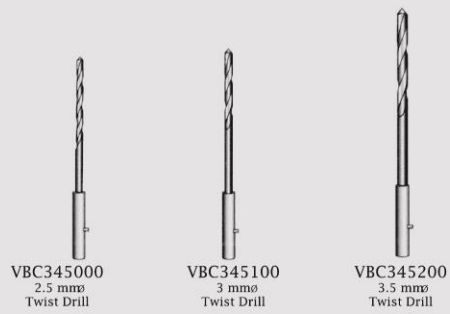
ارتوپدی
دریل ها



CE
SQS Certificate
ISO 9001:2000
ISO 13485:2003



Stille-Sherman
VBC344524
24 cm / 9 1/2"
VBC344500
Complete set



Stille
VBC345520
20 cm / 8"
VBC345500
Complete set

VBC346200
8 mmø
Spherical Burr

VBC346300
12 mmø
Spherical Burr

VBC346400
16 mmø
Spherical Burr

VBC346500
1 mmø
Twist Drill

VBC346600
1.5 mmø
Twist Drill

VBC346700
2 mmø
Twist Drill

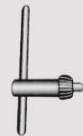


Orthopedic
Hand Drills
Handbohrapparate
Perforadores De Mano

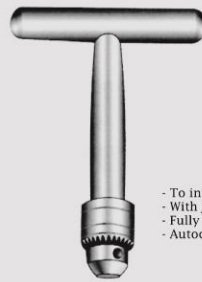


VBC347000

Handle with chuck and key, accomodating up to 6.35 mm(1/4"), perforated, for inserting and extracting nails, guide pins and wire guide drills.



VBC347600
Key only



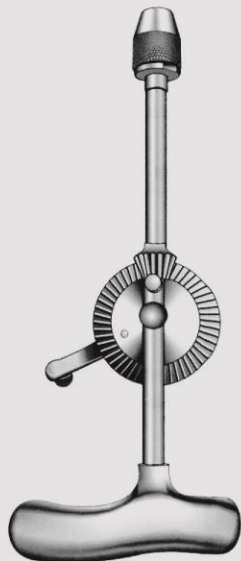
- To introduce bone pin
- With jacob chuck
- Fully cannulated
- Autoclaveable

Pin Chuck

VBC347515 6.35mm
15 cm / 6"
VBC347514 4.50mm
14 cm / 5 1/2"



VBC348000



Moore
VBC348500



VBC348600
9 cm
3.2 mmØ



VBC348700
7 cm
3.2 mmØ

VBC348800
Complete with a set of
twist drill ref:
VBC348600, VBC348700

ارتویدی
دریل ها



SQS Certificate
ISO 9001:2000
ISO 13485:2003

251



Orthopedic
Hand Drills and Chuck
Handbohrapparate und Griffe
Perforadores De Mano Y Mandril

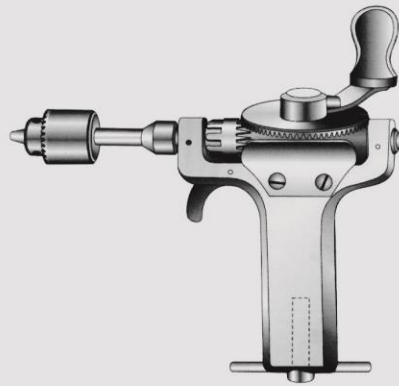
ارتوپدی
دریل ها



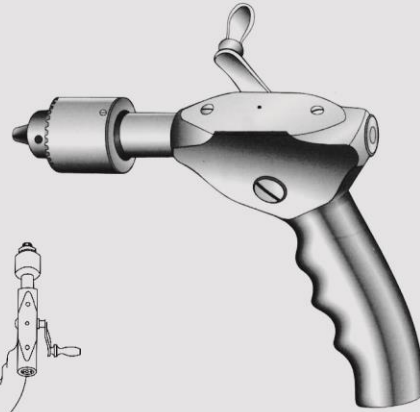
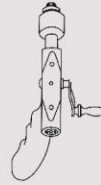
CE

SQS Certificate
ISO 9001:2000
ISO 13485:2003

252



Bunnell
VBC349024
24 cm / 9 1/2"



Ralk
VBC349500
Normal shaft
VBC349600
Long shaft



Jacobs
VBC350100 Small
VBC350200 Large
Stainless steel



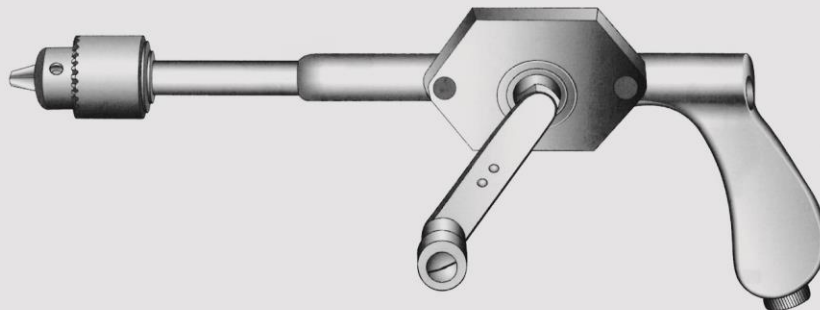
VBC350500
Key for jacobs chuck
Stainless steel



VBC351000Small
VBC351100Large
Chuck chrome plated



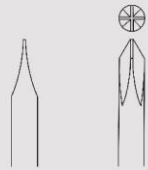
VBC351200
Key for
chrome plated chuck



VBC351500
American model



Williams
VBC352024
24 cm / 9 1/2"



VBC352517
17 cm / 6 3/4"
Ferozell handle



Lane
VBC353025
25 cm / 10"
Ferozell handle



VBC353517
17 cm / 6 3/4"
VBC353525
25 cm / 10"
Ferozell handle



VBC354017
17 cm / 6 3/4"
VBC354025
25 cm / 10"
Ferozell handle



Hexagon
VBC354517
17 cm / 6 3/4"
VBC354525
25 cm / 10"
Ferozell handle



Hexagon
VBC355017
17 cm / 6 3/4"
VBC355025
25 cm / 10"
Ferozell handle



Hexagon
VBC355517
17 cm / 6 3/4"
VBC355525
25 cm / 10"
Ferozell handle



VBC356500
Sleeve only



VBC356600
2.5 mm



VBC356700
3.5 mm



VBC356800
4.5 mm

Hexagon
VBC356018
18 cm / 7"
1.5 mm tip
With sleeve

Orthopedic Screw Drivers Schraubenzieher Destornilladores

ارتوپدی
پیچ گوشتی ها



SQS Certificate
ISO 9001:2000
ISO 13485:2003

253



Orthopedic
Lead Hand
Bleihände
Manoplas de plomo

ارتوپدی



CE

SQS Certificate
ISO 9001:2000
ISO 13485:2003

254



VBC357000 Forchildren
VBC357100 Foradults

www.Diamondmed.ir



Orthopedic
Nail Instruments,
Finger Ring Saws
Instrumente Fur
Finger-und Zehennagel,
Fingerringsagen
Instrumentos Para Unas,
Sierras Para Abrir Anillos



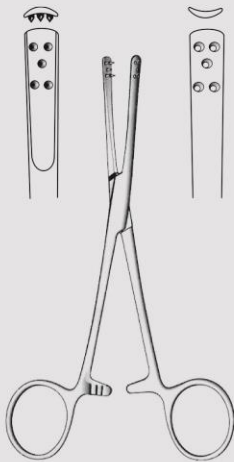
VBC357517
17 cm / 6 3/4"
Ring cutter



Walton
VBC358016
16 cm / 6 1/4"
VBC358116
Spare blade for ring cutters



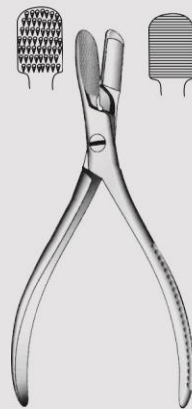
VBC358517
17 cm / 6 3/4"
Ring cutter



Penner
VBC359015
15.5 cm / 6"



Radolf
VBC359513
13.5 cm / 5 3/4"



VBC360114
14.5 cm / 5 3/4"
Nail extracting forceps



Coupe Clamp
VBC360514
14 cm / 5 1/2"
Plastic

ارتوپدی
حلقه برها



CE

SQS Certificate
ISO 9001:2000
ISO 13485:2003

255



Orthopedic
Bone Currettes, Double Ended
Scharfe Doppeloffel
Cucharillas de doble extremo

ارتوپدی
کورت ها



CE

SQS Certificate
ISO 9001:2000
ISO 13485:2003

256



VBC361021
21 cm / 8 1/4"

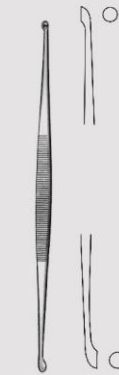


Williger
13.5 cm / 5 1/4"

VBC045900
Fig. 00/0

VBC045901
Fig. 0/1

VBC045912
Fig. 1/2



Martini
VBC361514
14 cm / 5 1/2"



Volkman

VBC362013
13 cm / 5"

VBC362014
14 cm / 5 1/2"

VBC362017
17 cm / 6 3/4"



Volkman

VBC362513
13 cm / 5"

VBC362516
16 cm / 6 1/4"

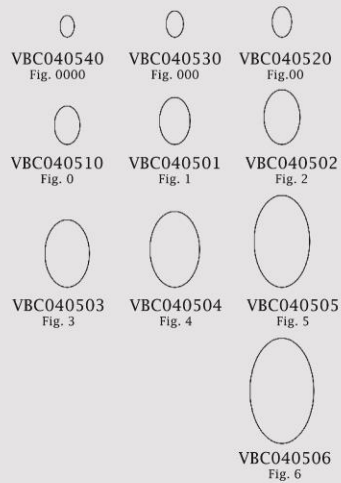
VBC362520
20 cm / 8"



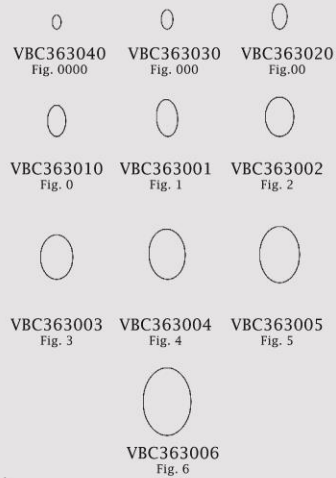
**Orthopedic
Bone Currettes
Scharfe Loffel
Cucharillas Cortantes**



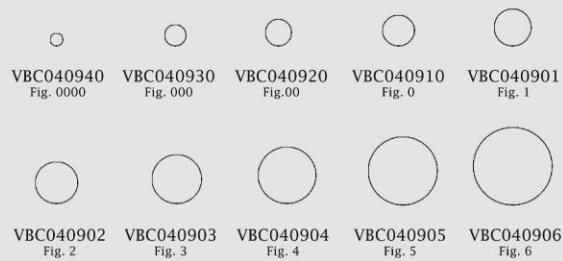
Volkman
17 cm / 6 3/4"



Spratt
17 cm / 6 3/4"



Bruns
17 cm / 6 3/4"



ارتوپدی
کورت ها



CE

SQS Certificate
ISO 9001:2000
ISO 13485:2003

257



Orthopedic
Bone Currettes
Scharfe Loffel
Cucharillas Cortantes

ارتوپدی
کورت ها



CE









SQS Certificate
ISO 9001:2000
ISO 13485:2003

258



Schede

- | | | | | | | |
|---|---|---|---|---|---|---|
|  |  |  |  |  |  |  |
| VBC363530
Fig. 000 | VBC363520
Fig.00 | VBC363510
Fig. 0 | VBC363501
Fig. 1 | VBC363502
Fig. 2 | VBC363503
Fig. 3 | BC363504
Fig. 4 |

- | | |
|---|---|
|  |  |
| VBC205500
Fig. 00 | VBC205600
Fig. 00 |
|  |  |
| VBC205501
Fig. 0 | VBC205601
Fig. 0 |
|  |  |
| VBC205502
Fig. 1 | VBC205602
Fig. 1 |
|  |  |
| VBC205503
Fig. 2 | VBC205603
Fig. 2 |



Williger
17.5 cm / 7"



25 cm / 9 3/4"

- | | | |
|---|---|-----------|
|  |  | VBC364025 |
|  |  | VBC364125 |
|  |  | VBC364225 |



Orthopedic
Bone Currettes
Scharfe Löffel
Cucharillas Cortantes



VBC044501
Fig. 1

VBC044502
Fig. 2

VBC044503
Fig. 3

VBC044504
Fig. 4

VBC044505
Fig. 5

VBC044506
Fig. 6



VBC044601
Fig. 1

VBC044602
Fig. 2

VBC044603
Fig. 3

VBC044604
Fig. 4

VBC044605
Fig. 5

VBC044606
Fig. 6

VBC364524
Fig. 1

VBC364624
Fig. 2

VBC364724
Fig. 3

VBC364824
Fig. 4

VBC364924
Fig. 5

VBC365024
Fig. 6



Mod. USA
16 cm / 6 3/4"



VBC044801
Fig. 1

VBC044802
Fig. 2

VBC044803
Fig. 3

VBC044804
Fig. 4

VBC044805
Fig. 5

VBC044806
Fig. 6



Simon
24 cm / 9 1/2"



Halle
21 cm / 8 3/4"

VBC365521
Fig. 1

VBC365621
Fig. 2

VBC365721
Fig. 3

ارتوپدی
کورت



CE

SQS Certificate
ISO 9001:2000
ISO 13485:2003

259



**Orthopedic
Bone Currettes
Scharfe Loffel
Cucharillas Cortantes**

ارتویدیک
کور تہا



SQS Certificate
ISO 9001:2000
ISO 13485:2003

260

Add "N" to the item code for Teflon Handle.

VBC038140
Fig. 0000

VBC038130
Fig. 000

VBC038120
Fig. 00

VBC038110
Fig. 0

VBC038101
Fig. 1

VBC038102
Fig. 2

VBC038103
Fig. 3

VBC038104
Fig. 4

VBC038105
Fig. 5

VBC038106
Fig. 6



Volkman
17 cm / 6 3/4"
Ferrozell handle

VBC366027
Fig. 0

VBC366127
Fig. 1

VBC366227
Fig. 2

VBC366327
Fig. 3

VBC366427
Fig. 4



Volkman
27 cm / 10 3/4"
Ferrozell handle

VBC367023 Straight
VBC368023 Angled 45°
Fig. 000

VBC367123 Straight
VBC368123 Angled 45°
Fig. 00

VBC367223 Straight
VBC368223 Angled 45°
Fig. 0

VBC367323 Straight
VBC368323 Angled 45°
Fig. 1

VBC367423 Straight
VBC368423 Angled 45°
Fig. 2

VBC367523 Straight
VBC368523 Angled 45°
Fig. 3

VBC367623 Straight
VBC368623 Angled 45°
Fig. 4

VBC367723 Straight
VBC368723 Angled 45°
Fig. 5

VBC367823 Straight
VBC368823 Angled 45°
Fig. 6



Brun
23 cm / 9"
With solid hexagonal handle

VBC369028 Straight
VBC370028 Angled 45°
Fig. 000

VBC369128 Straight
VBC370128 Angled 45°
Fig. 00

VBC369228 Straight
VBC370228 Angled 45°
Fig. 0

VBC369328 Straight
VBC370328 Angled 45°
Fig. 1

VBC369428 Straight
VBC370428 Angled 45°
Fig. 2

VBC369528 Straight
VBC370528 Angled 45°
Fig. 3

VBC369628 Straight
VBC370628 Angled 45°
Fig. 4

VBC369728 Straight
VBC370728 Angled 45°
Fig. 5

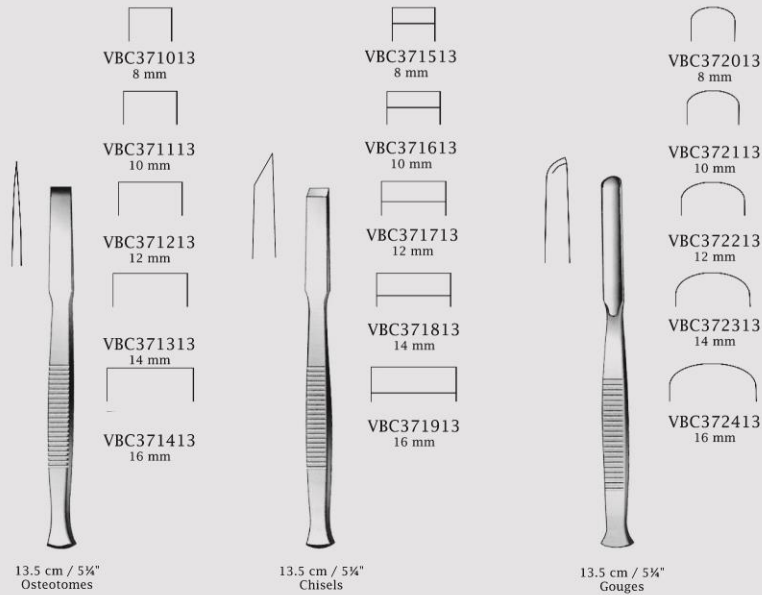
VBC369828 Straight
VBC370828 Angled 45°
Fig. 6



Cobb
28 cm / 11"
Knurled handle
Stainless steel



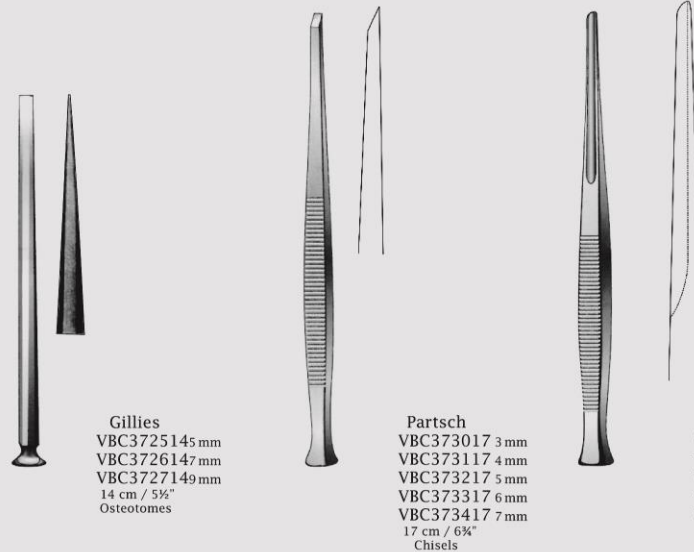
Orthopedic
Bone Osteotomes Chisels And Gouges
Meißel Und Osteotome
Cinceles Y Gubias Para Huesos



13.5 cm / 5 1/4"
Osteotomes

13.5 cm / 5 1/4"
Chisels

13.5 cm / 5 1/4"
Gouges



Gillies
VBC3725145 mm
VBC3726147 mm
VBC3727149 mm
14 cm / 5 1/2"
Osteotomes

Partsch
VBC373017 3 mm
VBC373117 4 mm
VBC373217 5 mm
VBC373317 6 mm
VBC373417 7 mm
17 cm / 6 3/4"
Chisels

Partsch
VBC373517 3 mm
VBC373617 4 mm
VBC373717 5 mm
VBC373817 6 mm
VBC373917 7 mm
17 cm / 6 3/4"
Gouges

ارتوپدی
استاتوم
چیزل
گوز



SQS Certificate
ISO 9001:2000
ISO 13485:2003

261



Orthopedic
Bone Osteotomes
Chisels And Gouges
Meibel Und Osteotome
Cinceles Y Gubias
Para Huesos

ارتوپدی
استاتوم
چیزل
گوز



CE

SQS Certificate
ISO 9001:2000
ISO 13485:2003

262



Partsch
Chisels

VBC020602 13.5 cm / 5¼" 2 mm
VBC020702 17 cm / 6¾" 2 mm

VBC020603 13.5 cm / 5¼" 3 mm
VBC020703 17 cm / 6¾" 3 mm

VBC020604 13.5 cm / 5¼" 4 mm
VBC020704 17 cm / 6¾" 4 mm

VBC020605 13.5 cm / 5¼" 5 mm
VBC020705 17 cm / 6¾" 5 mm

VBC020606 13.5 cm / 5¼" 6 mm
VBC020706 17 cm / 6¾" 6 mm



Partsch
Gouges

VBC021002 13.5 cm / 5¼" 2 mm
VBC021102 17 cm / 6¾" 2 mm

VBC021003 13.5 cm / 5¼" 3 mm
VBC021103 17 cm / 6¾" 3 mm

VBC021004 13.5 cm / 5¼" 4 mm
VBC021104 17 cm / 6¾" 4 mm

VBC021005 13.5 cm / 5¼" 5 mm
VBC021105 17 cm / 6¾" 5 mm

VBC021006 13.5 cm / 5¼" 6 mm
VBC021106 17 cm / 6¾" 6 mm



Alexander
18 cm / 7"
Chisels

VBC374018 4 mm
VBC374118 6 mm
VBC374218 8 mm

VBC374318 10 mm
VBC374418 12 mm
VBC374518 14 mm



Alexander
18 cm / 7"
Gouge

VBC375018 4 mm
VBC375118 6 mm
VBC375218 8 mm

VBC375318 10 mm
VBC375418 12 mm
VBC375518 14 mm



Orthopedic
Bone Osteotomes
Chisels And Gouges
Meibel Und Osteotome
Cinceles Y Gubias Para Huesos



Lucas
VBC376016 4 mm
VBC376116 6 mm
16 cm / 6 1/4"



Lucas
VBC376516 3 mm
VBC376616 5 mm
16 cm / 6 1/4"



Cottle
VBC3770184 mm
VBC3771186 mm
VBC3772188 mm
VBC37731810 mm
VBC37741812 mm
18 cm / 7"
With depth markings



Cottle
VBC378018 4mm
VBC378118 7mm
VBC378218 9mm
VBC378318 12mm
18 cm / 7"
With depth markings



Eastmann
VBC379519 3 mm
VBC379619 5 mm
19 cm / 7 1/2"



East Grinstead (Ward)
VBC380018 3 mm
VBC380118 5 mm
18 cm / 7"



Cottle
VBC378518
18 cm / 7"
8 mm
Fishtail chisel, with protected ends



East Grinstead (Ward)
VBC379018 3 mm
VBC379118 5 mm
18 cm / 7"

ارتوپدی
استاتوم
چیزل
گوژ



CE

SQS Certificate
ISO 9001:2000
ISO 13485:2003

263



Orthopedic
Bone Osteotome Chisels
Meißel
Cinceles Para Huesos

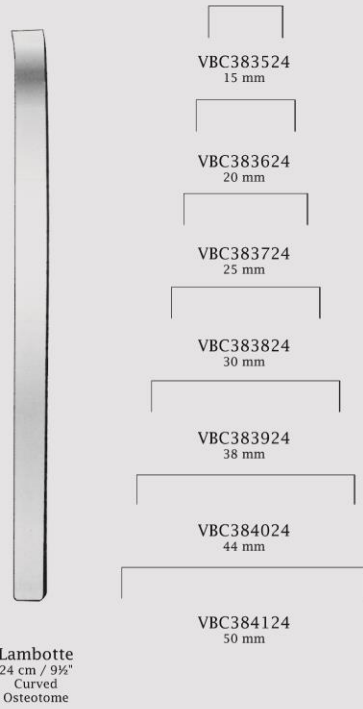
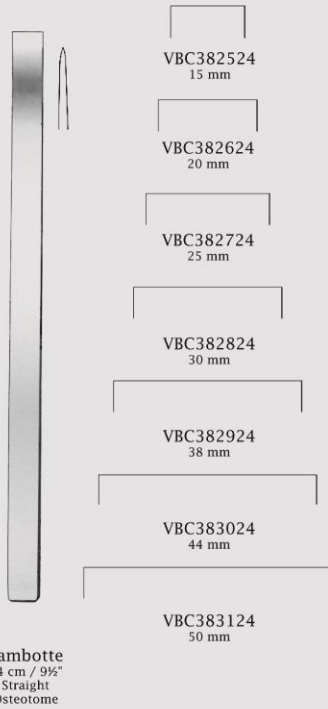
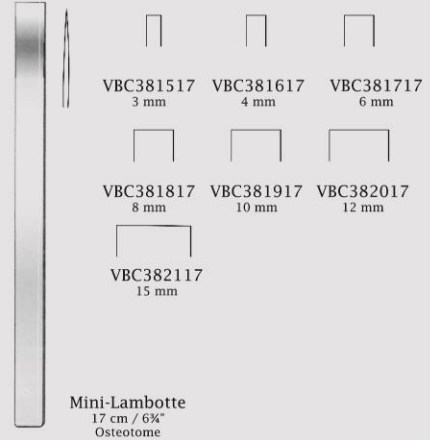
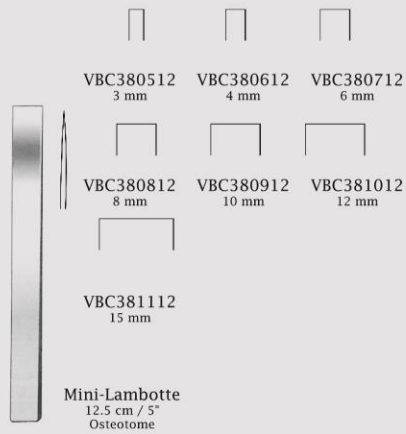
ارتوپدی
استاتوم ها



CE

SQS Certificate
ISO 9001:2000
ISO 13485:2003

264

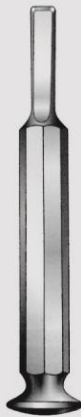
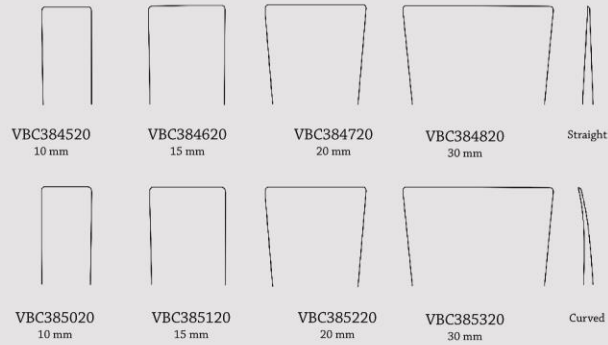




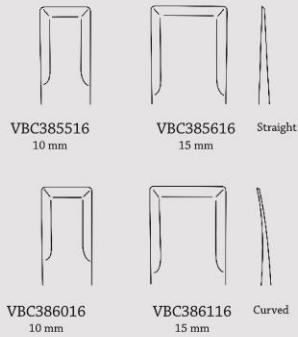
Orthopedic
Bone Osteotome Chisels
Meibei
Cinceles Para Huesos



Tossier
20 cm / 7 7/8"
For taking grafts from ilium and tibia



Tossier
16 cm / 6 1/4"
For taking grafts from the calva



Key
VBC386519 19 cm / 7 1/2"
VBC386521 21 cm / 8 1/4"
Periosteal elevator

ارتوپدی
استاتوم



CE

SQS Certificate
ISO 9001:2000
ISO 13485:2003

265



Orthopedic
Bone Osteotome Chisels And Gouges
Meißel Und Osteotome
Cinceles Y Gubias Para Huesos

ارتوپدی
استاتوم
چیزل
گوژ



SQS Certificate
ISO 9001:2000
ISO 13485:2003

266



Stille
VBC387020 10 mm
VBC387120 12 mm
VBC387220 15 mm
VBC387320 20 mm
VBC387420 25 mm
20.5 cm / 8"
Chisels



Stille
VBC388020 10 mm
VBC388120 12 mm
VBC388220 15 mm
VBC388320 20 mm
VBC388420 25 mm
20.5 cm / 8"
Gouges



Stille
VBC389020 10 mm
VBC389120 12 mm
VBC389220 15 mm
VBC389320 20 mm
VBC389420 25 mm
20.5 cm / 8"
Gouges
For taking grafts from the ribs



Stille
VBC390020 8 mm
VBC390120 10 mm
VBC390220 12 mm
VBC390320 15 mm
VBC390420 20 mm
VBC390520 25 mm
20.5 cm / 8"
Osteotomes



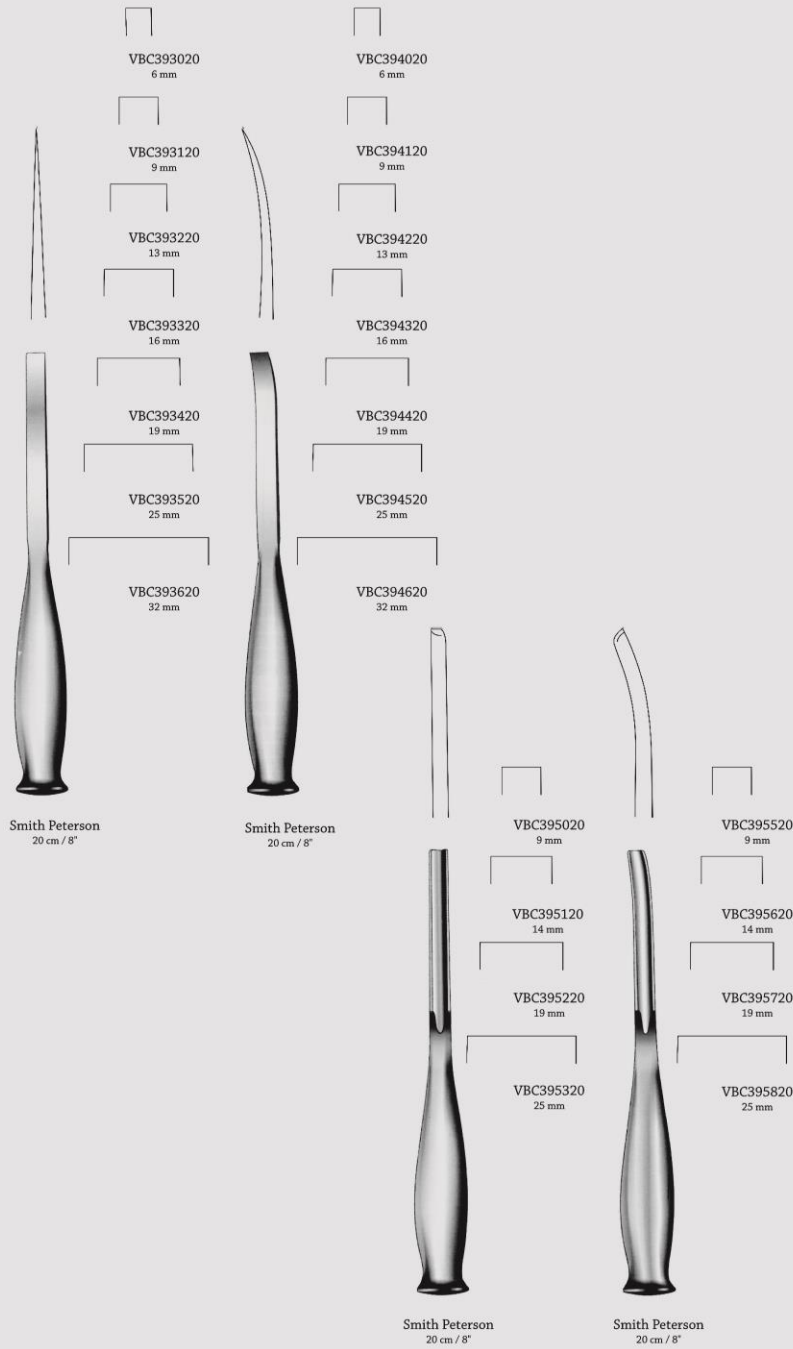
Stille
VBC391020 10 mm
VBC391120 12 mm
VBC391220 15 mm
VBC391320 20 mm
VBC391420 25 mm
20.5 cm / 8"
Osteotomes, straight



Stille
VBC392020 10 mm
VBC392120 12 mm
VBC392220 15 mm
VBC392320 20 mm
VBC392420 25 mm
20.5 cm / 8"
Osteotomes, curved



Orthopedic
Osteotome And Gouges
Osteotome, HohlmeiBel
Osteotomos, Gubias



ارتوپدی
استاتوم



CE

SQS Certificate
ISO 9001:2000
ISO 13485:2003

267



Orthopedic
Bone Chisels and Osteotome
MeiBel und Osteotome
Cinceles para huesos

ارتوپدی
استاتوم
چیزل



CE

SQS Certificate
ISO 9001:2000
ISO 13485:2003

268

Add "N" to the item code for Teflon Handle. Add "Z" to the item code for Ferrozell Handle.

VBC396024 24 cm / 9½"
VBC396518 18 cm / 7"
6 mm

VBC396124 24 cm / 9½"
VBC396618 18 cm / 7"
13 mm

VBC396224 24 cm / 9½"
VBC396718 18 cm / 7"
19 mm

VBC396324 24 cm / 9½"
VBC396818 18 cm / 7"
25 mm

VBC396424 24 cm / 9½"
32 mm

6 mm 10 mm 13 mm 16 mm

19 mm 25 mm

32 mm

VBC397024 6 mm VBC399024
VBC397124 10mm VBC399124
VBC397224 13mm VBC399224
VBC397324 16mm VBC399324
VBC397424 19mm VBC399424
VBC397524 25mm VBC399524
VBC397624 32mm VBC399624
24 cm / 9½"
Straight 24 cm / 9½"
Curved

VBC398018 6 mm VBC400118
VBC398118 10mm VBC400218
VBC398218 13mm VBC400318
VBC398318 16mm VBC400418
VBC398418 19mm VBC400518
VBC398518 25mm VBC400618
VBC398618 32mm VBC400718
18 cm / 7"
Straight 18 cm / 7"
Curved

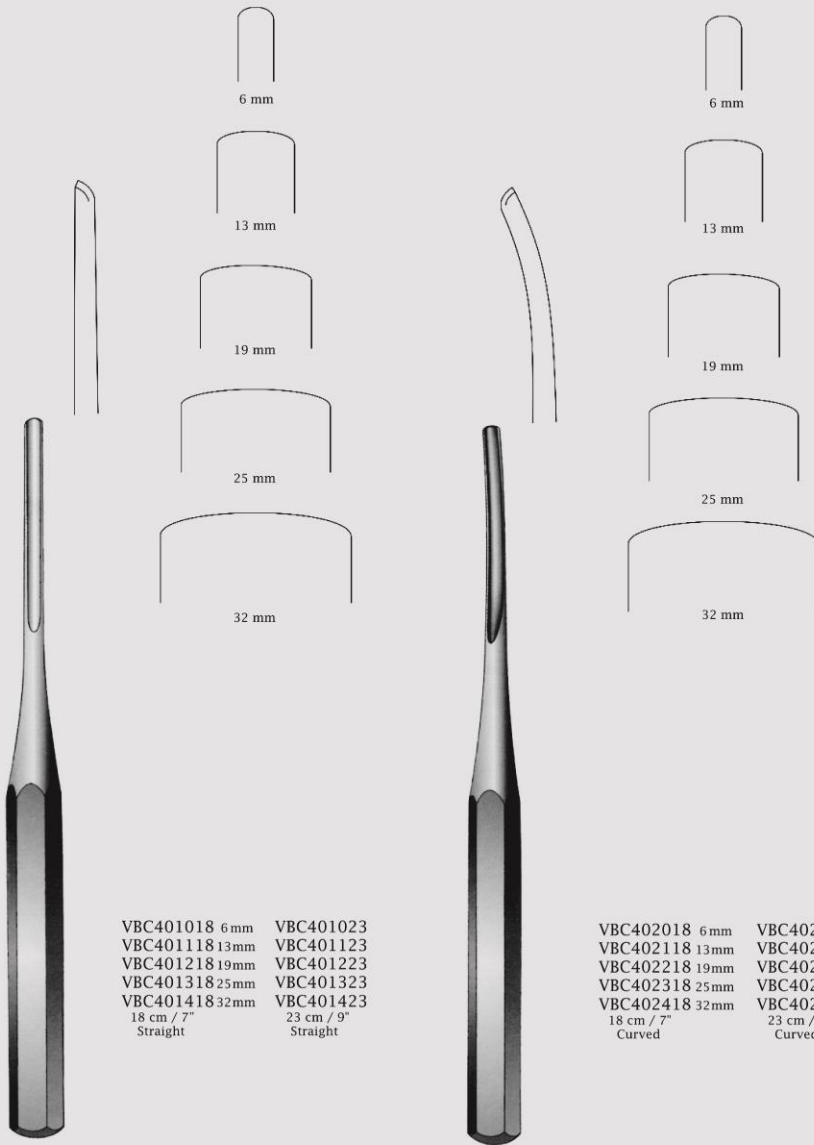
Hibbs / Hilder
Chisel

Hibbs / Hilder
Osteotome

Add "N" to the item code for Teflon Handle. Add "Z" to the item code for Ferrozell Handle.



Orthopedic
Gouges
Hohlmeißel
Gubias



Hilder
Gouge

VBC401018 6mm	VBC401023
VBC401118 13mm	VBC401123
VBC401218 19mm	VBC401223
VBC401318 25mm	VBC401323
VBC401418 32mm	VBC401423
18 cm / 7"	23 cm / 9"
Straight	Straight

Hilder
Gouge

VBC402018 6mm	VBC402023
VBC402118 13mm	VBC402123
VBC402218 19mm	VBC402223
VBC402318 25mm	VBC402323
VBC402418 32mm	VBC402423
18 cm / 7"	23 cm / 9"
Curved	Curved

ارتوپدی
گوژها



CE

SQS Certificate
ISO 9001:2000
ISO 13485:2003

269



Orthopedic
Chisels
FlachmeiBel
Cinceles

ارتوپدی
چیزل ها








CE

SQS Certificate
ISO 9001:2000
ISO 13485:2003

270

Add "N" to the item code for Teflon Handle. Add "T" to the item code for Ferrozell Handle.

 Farabeuf 21 cm / 8 3/4" Osteotome	<p>VBC403021 10 mm</p> <p>VBC403121 15 mm</p> <p>VBC403221 20 mm</p> <p>VBC403321 25 mm</p> <p>VBC403421 30 mm</p>	 Farabeuf 25 cm / 10" Chisel	<p>VBC404025 6 mm</p> <p>VBC404125 8 mm</p> <p>VBC404225 10 mm</p> <p>VBC404325 12 mm</p> <p>VBC404425 15 mm</p> <p>VBC404525 20 mm</p> <p>VBC404625 25 mm</p> <p>VBC404725 30 mm</p>	 Hautant 13 cm / 5" Chisel	<p>VBC405013 2 mm</p> <p>VBC405113 4 mm</p> <p>VBC405213 5 mm</p> <p>VBC405313 6 mm</p> <p>VBC405413 8 mm</p> <p>VBC405513 10 mm</p> <p>VBC405613 12 mm</p>
 Judet 22 cm / 8 3/4" Chisel	<p>VBC406022 10 mm</p> <p>VBC406122 15 mm</p> <p>VBC406222 20 mm</p> <p>VBC406322 25 mm</p> <p>VBC406422 30 mm</p> <p>VBC406522 35 mm</p>			 Letourne 35 cm / 14" Gouge	<p>VBC407035 6 mm</p>



Lucas Championniere
21 cm / 8 1/4"

VBC407521
35 mm



Maceven
20 cm / 8"

VBC408020
10 mm

VBC408120
15 mm

VBC408220
20 mm



Mante
13 cm / 5"

VBC408513
3.5 mm



Ombredanne
14 cm / 5 1/2"

VBC409014
10 mm

VBC409114
15 mm

VBC409214
20 mm

Orthopedic
Chisels
FlachmeiBel
Cinceles

ارتوپدی
چیزل ها



Partsch

VBC410000 14 cm
VBC410500 17 cm
2 mm

VBC410100 14 cm
VBC410600 17 cm
3 mm

VBC410200 14 cm
VBC410700 17 cm
4 mm

VBC410300 14 cm
VBC410800 17 cm
6 mm

VBC410400 14 cm
VBC410900 17 cm
8 mm



Poirier
16 cm / 6 1/4"

VBC411516
4 mm

VBC411616
6 mm

VBC411716
8 mm

VBC411816
10 mm

VBC411916
12 mm

VBC412016
14 mm



Portmann
16 cm / 6 1/4"

VBC412516
6 mm

VBC412616
8 mm

VBC412716
10 mm

VBC412816
12 mm



CE

SQS Certificate
ISO 9001:2000
ISO 13485:2003

271



Orthopedic
Gouges
Hohlmeißel
Gubias

ارتوپدی
گوژها



CE

SQS Certificate
ISO 9001:2000
ISO 13485:2003

272

Add "N" to the item code for Teflon Handle. Add "Z" to the item code for Ferrozell Handle.



Cobb
30 cm / 11¾"
Blade 6 mm

- VBC413030
Straight
- VBC413130
Half curved
- VBC413230
Curved



Hautant
13 cm / 5"

VBC414513
2 mm

VBC414613
4 mm

VBC414713
5 mm

VBC414813
6 mm

VBC414913
8 mm

VBC415013
10 mm

VBC415113
12 mm



Cobb
28 cm / 11"

VBC413528
8 mm

VBC413616
10 mm

VBC413716
12 mm



Guillaume
24 cm / 9½"

VBC414024
2 mm

VBC414124
4 mm

VBC414224
6 mm

VBC414324
8 mm



Honton
29.5 cm / 5"

VBC415529
Staright

VBC415629
Concave

VBC415729
Convex



Orthopedic
Gouges
HohlmeiBel
Gubias



Poirier-Trillat
20 cm / 8"

VBC416020
4 mm

VBC416120
6 mm

VBC416220
8 mm

VBC416320
10 mm

VBC416420
12 mm

VBC416520
14 mm



Poirier
16 cm / 6 1/4"

VBC417016
2 mm

VBC417116
4 mm

VBC417216
6 mm

VBC417316
8 mm

VBC417416
10 mm

VBC417516
12 mm

VBC417616
14 mm



Postel
25 cm / 10"



VBC418025 Straight
VBC418125 Angled 135°
VBC418225 Angled 150°
8 mm



Putti
25 cm / 10"

VBC418525
30 mm

ارتوپدی
گوژها



CE

SQS Certificate
ISO 9001:2000
ISO 13485:2003

273



Orthopedic
Osteotomes And Gouges
Osteotome und Hohlmeißel
Osteotomos Y Gubias

ارتوپدی
استاتوم ها
گوژها



CE

SQS Certificate
ISO 9001:2000
ISO 13485:2003

274

Add "N" to the item code for Teflon Handle. Add "Z" to the item code for Ferrozell Handle.



- VBC419023
20 mm
- VBC419123
27 mm
- VBC419223
30 mm

Smith - Petersen
23.5 cm / 9¼"



- VBC419530
6 mm
- VBC419630
8 mm
- VBC419730
10 mm
- VBC419830
12 mm
- VBC419930
14 mm
- VBC420030
16 mm
- VBC420130
18 mm
- VBC420230
20 mm

Stagnara
30 cm / 12"



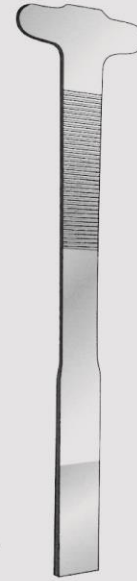
Cauchoix
25 cm / 10"

- VBC420525
8 mm
- VBC420625
10 mm
- VBC420725
12 mm
- VBC420825
14 mm
- VBC420925
16 mm
- VBC421025
18 mm
- VBC421125
20 mm
- VBC421225
25 mm



Farabeuf
21 cm / 8¼"

- VBC421521
10 mm
- VBC421621
12 mm
- VBC421721
15 mm
- VBC421821
20 mm
- VBC421921
25 mm
- VBC422021
30 mm



Robin
16 cm / 6¼"

- VBC422516
6 mm
- VBC422616
8 mm
- VBC422716
10 mm
- VBC422816
14 mm

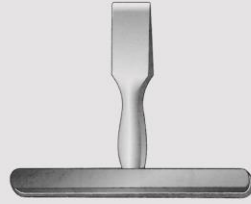
Add "N" to the item code for Teflon Handle. Add "Z" to the item code for Ferrozell Handle.



Orthopedic
Bone Chisels and Gouges
MeiBel und Osteotome
Cinceles y Gubias para Huesos



Lebsche
VBC423024
24.5 cm / 9 3/4"



Virchow
VBC423500
Skull breaker



VBC424022
22 cm / 8 3/4"



Brunetti
VBC424528
28 cm / 11"
Left



Brunetti
VBC425028
28 cm / 11"
Right



Cobb
VBC425529 Tip 10mm
VBC425629 Tip 13mm
VBC425729 Tip 19mm
29 cm / 11 1/2"
Spinal elevator



Cobb
VBC426028
28 cm / 11"
Spinal gouge
7 mm blade width



VBC426128
Straight



VBC426228
Medium curve



VBC426328
Strong curve



VBC426428
Reverse curve

ارتوپدی
چیزل ها
گوژها



CE

SQS Certificate
ISO 9001:2000
ISO 13485:2003

275



Orthopedic

Bone Osteotomes Chisels and Gouges
Osteotome und Hohlmeißel
Cinceles y Gubias para huesos

ارتوپدی
استاتوم
چیزل
گوژ



SQS Certificate
ISO 9001:2000
ISO 13485:2003

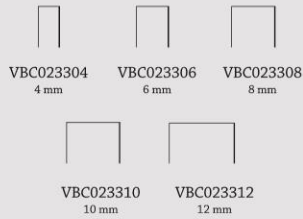
276



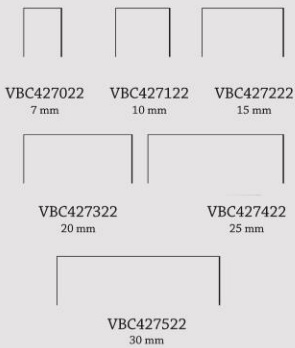
Mini-Lexer
18 cm / 7"
Ferrozell handle



Lexer
22 cm / 8 1/2"
Ferrozell handle



VBC023304 4 mm
VBC023306 6 mm
VBC023308 8 mm
VBC023310 10 mm
VBC023312 12 mm



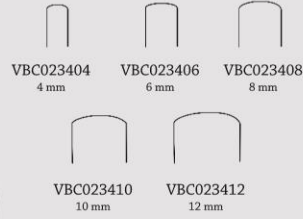
VBC427022 7 mm
VBC427122 10 mm
VBC427222 15 mm
VBC427322 20 mm
VBC427422 25 mm
VBC427522 30 mm



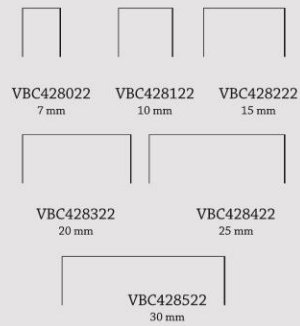
Mini-Lexer
18 cm / 7"
Ferrozell handle



Lexer
22 cm / 8 1/2"
Ferrozell handle



VBC023404 4 mm
VBC023406 6 mm
VBC023408 8 mm
VBC023410 10 mm
VBC023412 12 mm



VBC428022 7 mm
VBC428122 10 mm
VBC428222 15 mm
VBC428322 20 mm
VBC428422 25 mm
VBC428522 30 mm



Add "N" to the item code for Teflon Handle.



VBC429022
8 mm



VBC429122
12 mm



VBC429222
16 mm



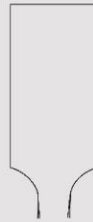
Obwegeser
22 cm / 8 3/4"



VBC429522
8 mm



VBC429622
12 mm



VBC429722
16 mm



VBC429822
20 mm



Obwegeser
22 cm / 8 3/4"

Orthopedic
Wedge Osteotomes,
Blade Osteotomes,
Keilosteotome,
Blattosteotome
Osteotomos de Cuna,
Osteotomos de Hojas

ارتوپدی
استاتوم ها



CE

SQS Certificate
ISO 9001:2000
ISO 13485:2003

277



Orthopedic
Spongiosa Gouges
Spongiosaentnahmemeißel
Cinceles de esponjosa

ارتوپدی
گوژها

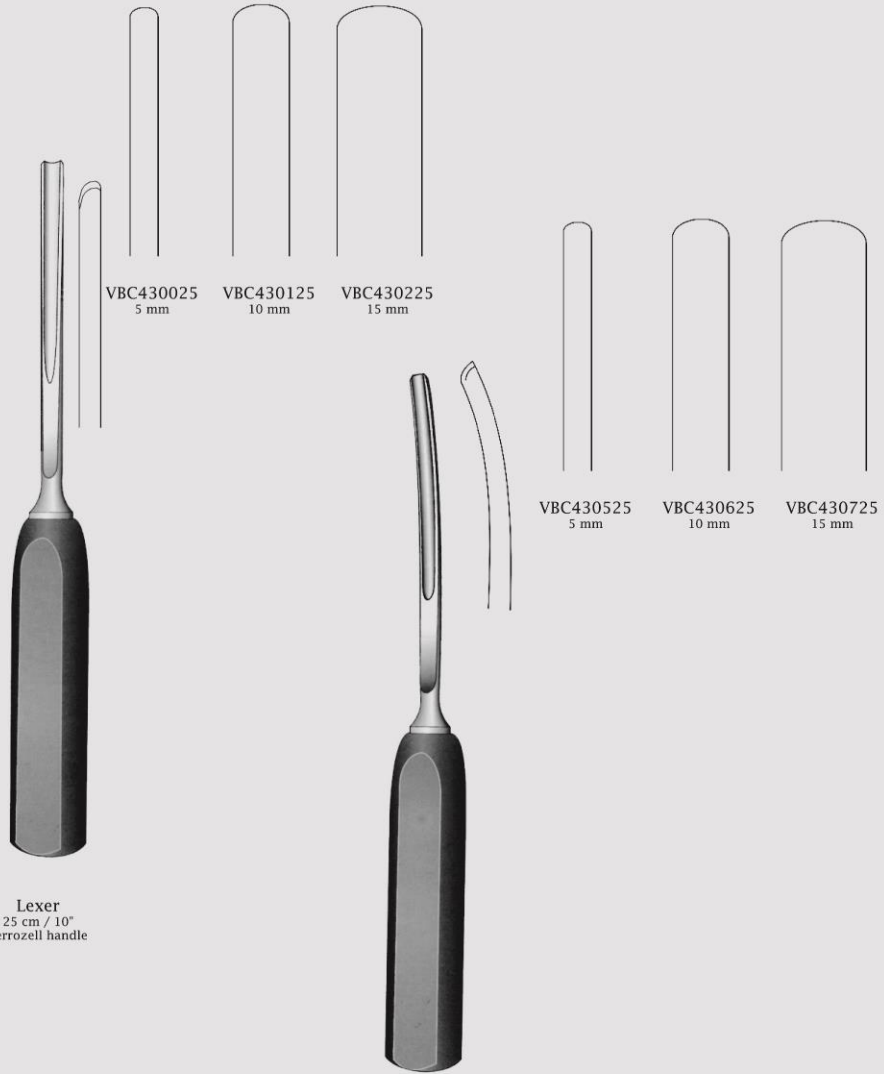


CE

SQS Certificate
ISO 9001:2000
ISO 13485:2003

278

Add "N" to the item code for Teflon Handle.



Lexer
25 cm / 10"
Ferrozell handle

Lexer
25 cm / 10"
Ferrozell handle

www.Diamondmed.ir



Orthopedic

Bone Osteotome Chisels And Gouges
Meißel Und Osteotome
Cinceles Y Gubias Para Huesos



VBC431024
24.5 cm / 9 1/2"
20 mm
Ferrozell handle

VBC431526
26.5 cm / 10 1/2"
16 mm
Ferrozell handle, curved

Lexer
VBC432027 10 mm
VBC432127 15 mm
27.5 cm / 10"
Ferrozell handle

Lexer
VBC432527 10 mm
VBC432627 15 mm
27.5 cm / 10"
Ferrozell handle

ارتوپدی
استاتوم
چیزل
گوژ



CE

SQS Certificate
ISO 9001:2000
ISO 13485:2003

279



Orthopedic
Spongiosa Gouges
SpongiosaentnahmemeiBel
Cinceles de esponjosa

ارتوپدی
گوژ



CE

SQS Certificate
ISO 9001:2000
ISO 13485:2003

280



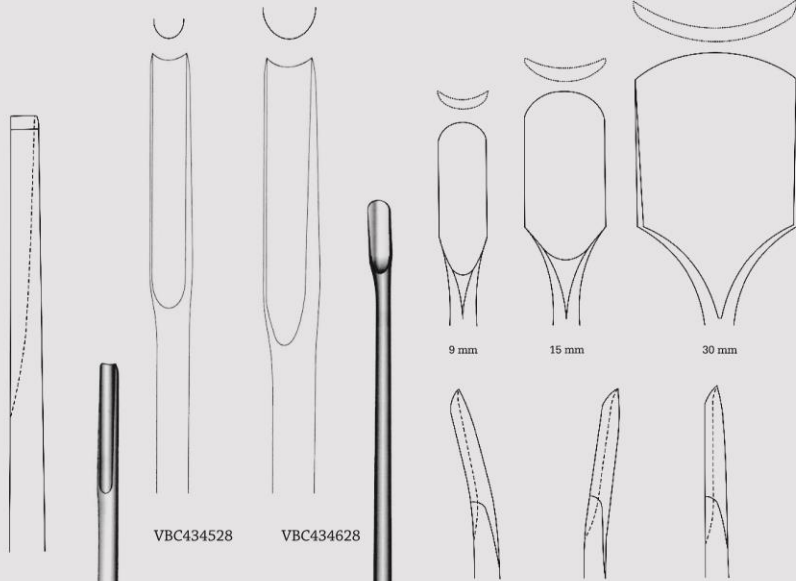
VBC433025 5 mm
VBC433125 10 mm
VBC433225 15 mm
25 cm / 10"
Ferrozell handle
Spongiosa gouge

Lamina
VBC433523 6 mm
VBC433623 8 mm
VBC433723 11 mm
VBC433823 16 mm
23.5 cm / 9 3/4"
Ferrozell handle

VBC434025 5 mm
VBC434125 10 mm
VBC434225 15 mm
25 cm / 10"
Curved
Ferrozell handle
Spongiosa gouge



Orthopedic
Gouges
Hohlmeißel
Gubias



VBC434528

VBC434628

9 mm

15 mm

30 mm

VBC435034	9 mm	VBC435534	9 mm	VBC436034	9 mm
VBC435134	15 mm	VBC435634	15 mm	VBC436134	15 mm
VBC435234	30 mm	VBC435734	30 mm	VBC436234	30 mm
Inclined forward		Inclined backward		Straight	



Lexer
28 cm / 11"
Ferrozell handle
Spongiosa gouge



Wagner
34 cm / 13½"
Ferrozell handle

Long handled thin concave osteotomes for removal of osteophytes as well as for creating small notches throughout the acetabular surface.
The instruments can also be used for removing bone cement from the narrow cavity when removing a total hip prosthesis.

ارتوپدی
استاتوم



CE

SQS Certificate
ISO 9001:2000
ISO 13485:2003

281



Orthopedic
Chisel Blades, Chisel Handle
MeiBelkingen, MeiBelgriff
Hojas de cincel, Mango para
hojas de cincel

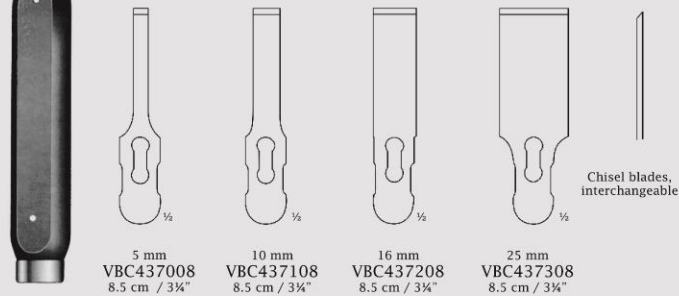
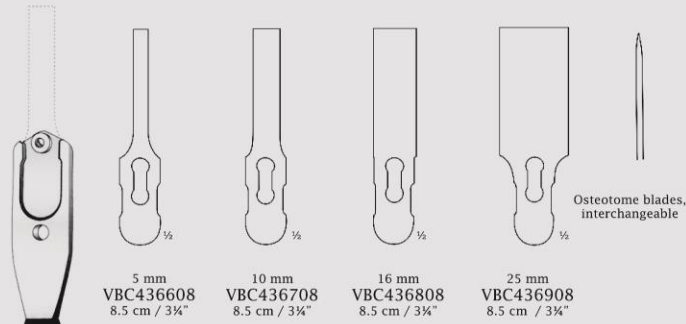
ارتوپدی
استاتوم ها



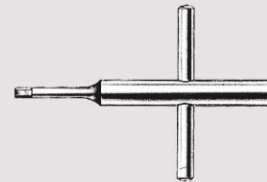
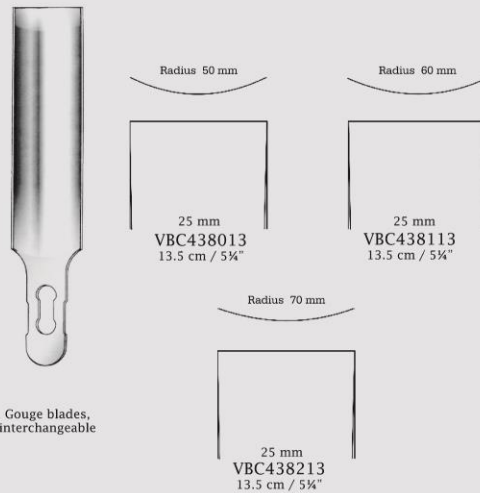
CE
SQS Certificate
ISO 9001:2000
ISO 13485:2003

282

Add "N" to the item code for Teflon Handle.



VBC436518
18.5 cm / 7 3/4"
Handle, only
Ferrozell handle

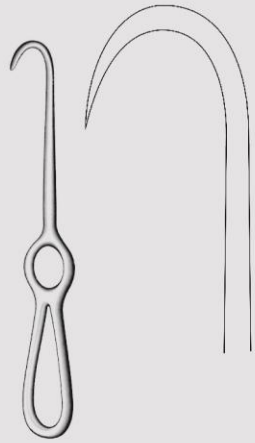


VBC437509
9 cm / 3 3/4"
Key
VBC437600
Spare screw

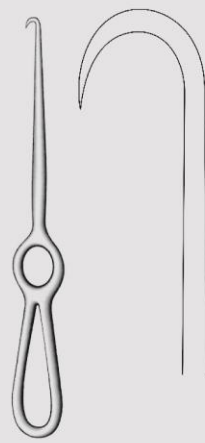


Orthopedic
Bone Hooks
Knochenhaken
Gancho para huesos

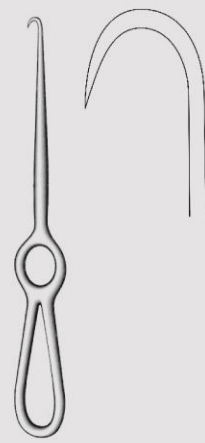
ارتوپدی
هوک ها



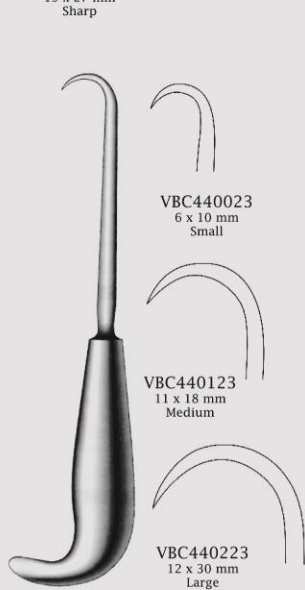
Volkmann
VBC438520
20 cm / 8"
19 x 27 mm
Sharp



Volkmann
VBC439023
23 cm / 9"
15 x 20 mm
Sharp



Volkmann
VBC439525
25 cm / 9 3/4"
15 x 20 mm
Sharp

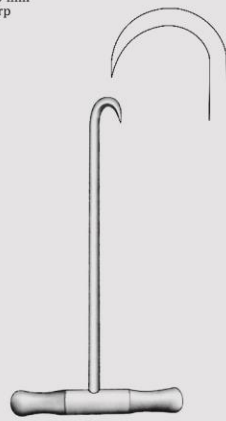


VBC440023
6 x 10 mm
Small

VBC440123
11 x 18 mm
Medium

VBC440223
12 x 30 mm
Large

23 cm / 9"
Sharp
Bone hook with grip handle



VBC440518
18 cm / 7"
18 x 21 mm
Sharp with T-handle
large, for femurs



Zygoma
VBC441017
17 cm / 6 3/4"



SQS Certificate
ISO 9001:2000
ISO 13485:2003

283



Orthopedic
Elevators
Elevatoriën
Elevadores

ارتوپدی
پریوست الویتور



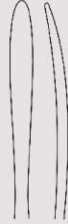
CE

SQS Certificate
ISO 9001:2000
ISO 13485:2003

284



Williger
VBC441516 Tip 4 mm
VBC441616 Tip 5 mm
VBC441716 Tip 6 mm
VBC441816 Tip 7 mm
16 cm / 6 1/4"



Langenbeck
20 cm / 8"



VBC442020
Tip 8 mm



VBC442120
Tip 10 mm



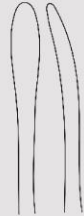
VBC444517
17 cm / 6 3/4"



8 mm



Langenbeck



VBC445017
17 cm / 6 3/4"
5 mm



VBC445117
17 cm / 6 3/4"
7 mm



VBC445020
20 cm / 8"
8 mm



VBC445120
20 cm / 8"
10 mm



Adson
17 cm / 6 3/4"



VBC445517



VBC445617



VBC445717



VBC445817



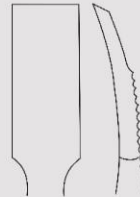
Orthopedic
Periosteal Raspatories
Raspatorien
Legras Periostotomos



Matson
VBC446022
22 cm / 8 3/4"



Alexander
VBC446520
20 cm / 8"



Semb

VBC447017
17.5 cm / 7"



VBC447121
21 cm / 8 1/4"



VBC447217
17.5 cm / 7"



VBC447321
21 cm / 8 1/4"



VBC447420
20.5 cm / 8"

ارتوپدی
پریوست



CE

SQS Certificate
ISO 9001:2000
ISO 13485:2003

285



Orthopedic
Periosteal Elevators
Raspatorien
Periostotomos, Legras

ارتوپدی
پریوست الویتور

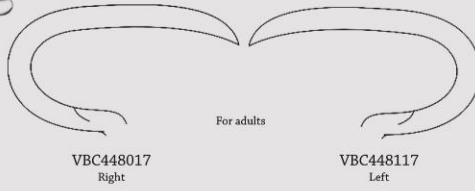


SQS Certificate
ISO 9001:2000
ISO 13485:2003

286

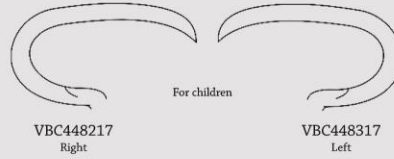


Doyen
17 cm / 6 3/4"



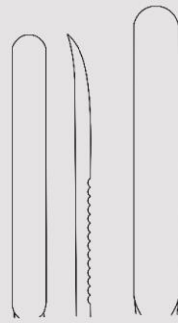
VBC448017
Right

VBC448117
Left



VBC448217
Right

VBC448317
Left



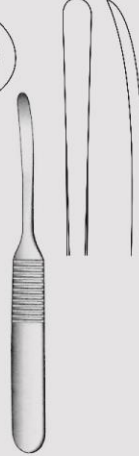
VBC449517
6 mm

VBC449617
8 mm

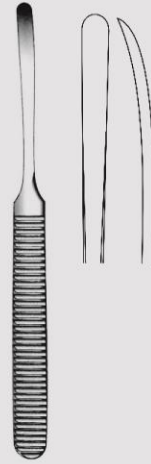
17 cm / 6 3/4"



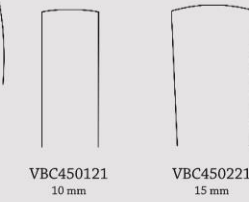
Lambotte
21 cm / 8 1/4"



Williger
VBC448513
13 cm / 5"
5 mm

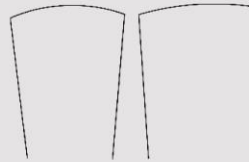


Williger
VBC449016 4 mm
VBC449116 5 mm
VBC449216 6 mm
VBC449316 7 mm
16 cm / 6 1/4"



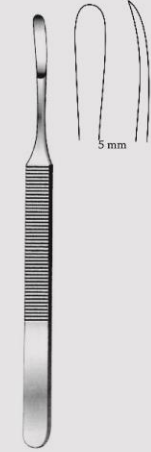
VBC450121
10 mm

VBC450221
15 mm



VBC450321
20 mm

VBC450421
25 mm

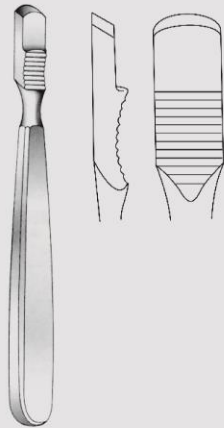


Konig
VBC450515
15.5 cm / 6"



Orthopedic
Periosteal Elevators
Raspatorien
Periostotomos

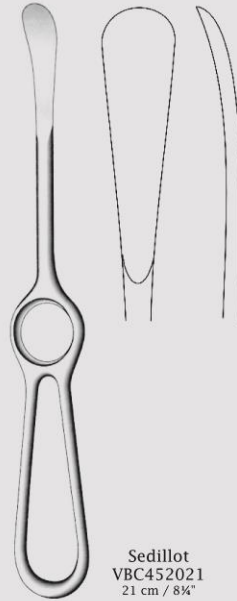
ارتوپدی
پریوست الویتورها



Farabeuf
VBC451015
15 cm / 6"
Straight



Farabeuf
VBC451515
15 cm / 6"
Curved



Sedillot
VBC452021
21 cm / 8 1/2"



16 cm / 6 1/4"
Delicate, Solid



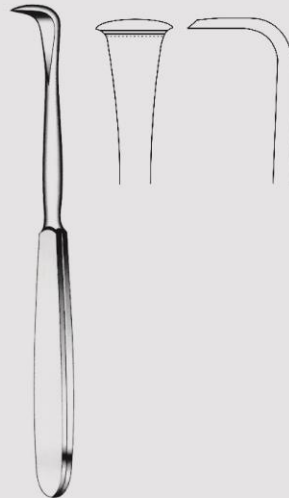
VBC051205
5 mm



VBC051206
6 mm



VBC051207
7 mm



Langenbeck
VBC452518
18 cm / 7"



CE

SQS Certificate
ISO 9001:2000
ISO 13485:2003

287



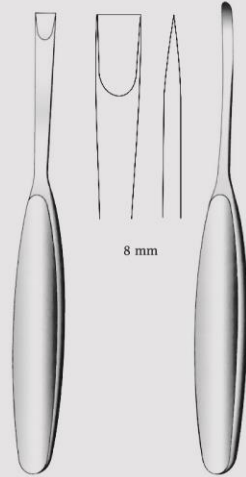
Orthopedic
 Periosteal Elevators
 Raspatorien
 Periostotomos

ارتویدی
 پریوست الویتور



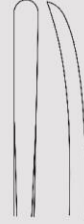
SQS Certificate
 ISO 9001:2000
 ISO 13485:2003

288



Cushing
 VBC453017
 17 cm / 6 3/4"

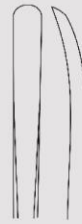
Cushing



VBC453517
 17 cm / 6 3/4"
 4 mm



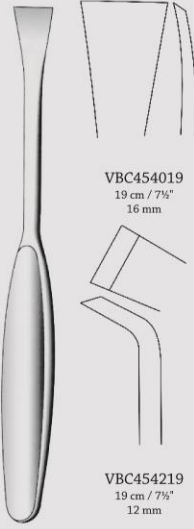
VBC453617
 17 cm / 6 3/4"
 6 mm



VBC453719
 19.5 cm / 7 3/4"
 5 mm

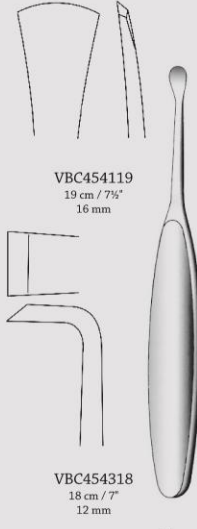


VBC453819
 19.5 cm / 7 3/4"
 7 mm



VBC454019
 19 cm / 7 1/2"
 16 mm

Langenbeck



VBC454119
 19 cm / 7 3/4"
 16 mm

VBC454318
 18 cm / 7"
 12 mm

Hoen



VBC454516
 16 cm / 6 1/4"
 7 mm



VBC454518
 18 cm / 7 1/4"
 15 mm



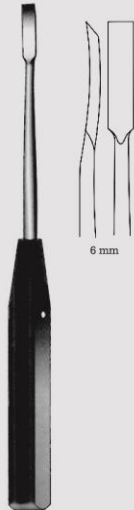
VBC454520
 19 cm / 7 1/2"
 20 mm



Orthopedic
Periosteal Elevators
Raspatorien
Periostotomos



VBC455018
18 cm / 7"
Ferozell handle



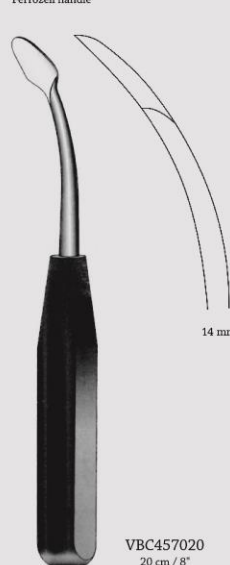
VBC455518
18 cm / 7"
Ferozell handle



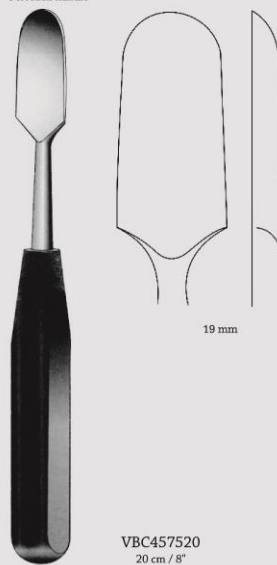
VBC456018
18 cm / 7"
Ferozell handle



VBC456520
20 cm / 8"
Ferozell handle



VBC457020
20 cm / 8"
Ferozell handle



VBC457520
20 cm / 8"
Ferozell handle

ارتوپدی
پریوست الویتور



CE

SQS Certificate
ISO 9001:2000
ISO 13485:2003

289



Orthopedic
Bone Levers
Knochenhebel
Elevadores para huesos

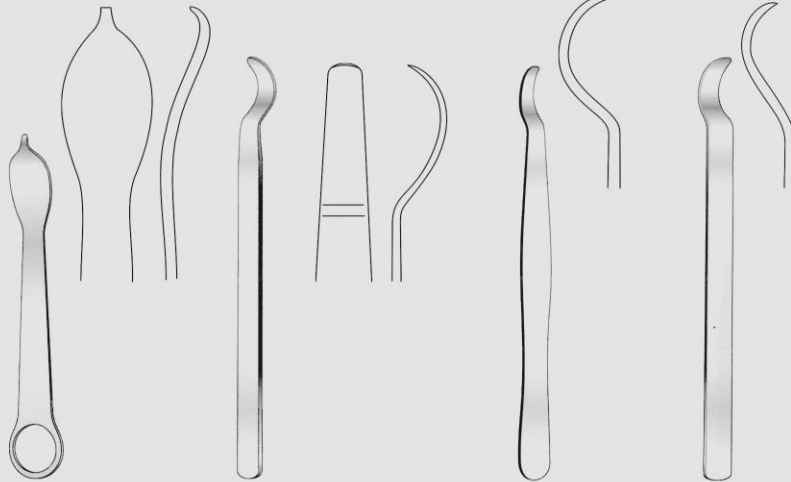
ارتوپدی
بنت (بن لیور)



CE

SQS Certificate
ISO 9001:2000
ISO 13485:2003

290

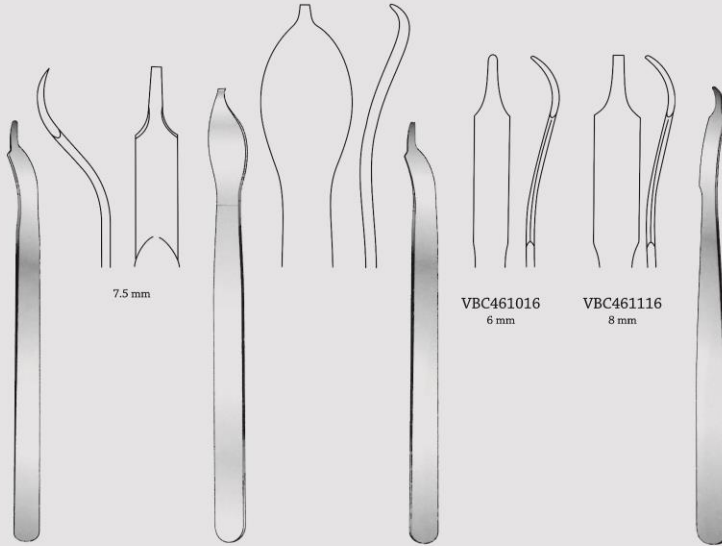


VBC458000
16 mm

VBC458514
14 cm / 5 1/2"

VBC459015
15 cm / 6"
5 mm

VBC459515
15 cm / 6"
7 mm



7.5 mm

VBC461016
6 mm

VBC461116
8 mm

Buck-Gramcko
VBC460115
15 cm / 6"

VBC460500
15 mm

Mini-Hohmann
16 cm / 6 1/4"

Freer
VBC461518
18.5 cm / 7 3/4"
Sharp/Blunt



Orthopedic
Bone Levers
Knochenhebel
Elevadores para huesos

ارتوپدی
بنت (بن لیور)



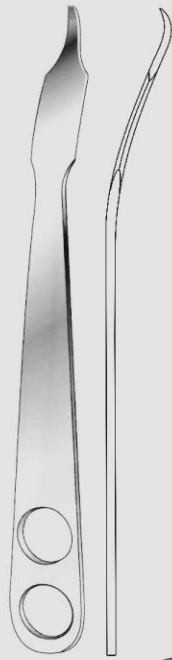
CE

SQS Certificate
ISO 9001:2000
ISO 13485:2003

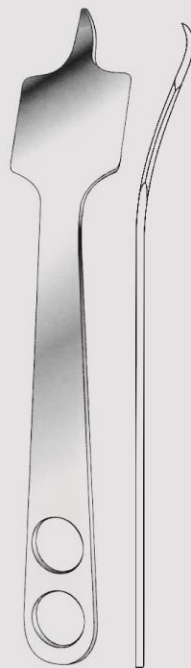
291



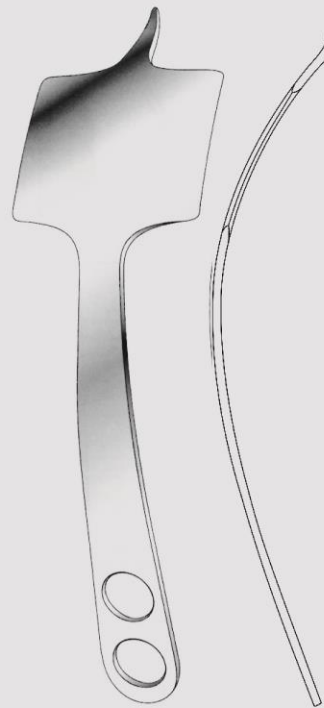
Hohmann
VBC462000
22 cm / 8 3/4"
8 mm



Hohmann
VBC462500
23.5 cm / 9 1/4"
18 mm



Hohmann
VBC463000
23.5 cm / 9 1/4"
43 mm



Hohmann
VBC463500
23.5 cm / 9 1/4"
70 mm



Orthopedic
Bone Levers
Knochenhebel
Elevadores para huesos

ارتوپدی
بنت (بن لیور)



CE

SQS Certificate
ISO 9001:2000
ISO 13485:2003

292



Hohmann
VBC464500
25.5 cm / 10"
22 mm

Hohmann
VBC465000
29 cm / 11"
33 mm

Hohmann
VBC464000
23.5 cm / 9 1/2"
43 mm

Hohmann
VBC465500
27.5 cm / 10 3/4"
24 mm

Lange-Hohmann
VBC466000
25.5 cm / 10"
22 mm



Orthopedic
 Bone Levers, Retractors
 Knochenhebel, Wundhaken
 Elevadores para huesos,
 Separadores



Taylor
 16.5 cm / 6½"

VBC466516 100 x 30 mm
 VBC466616 75 x 30 mm



Blount
 VBC468526
 26 cm / 10¼"
 Blunt



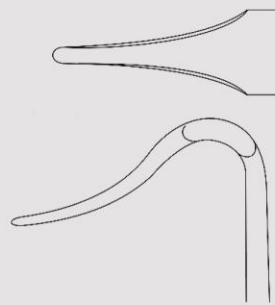
Bennett
 VBC467524 Small
 VBC467624 Large
 24 cm / 9½"



Blount
 VBC468026
 26 cm / 10¼"



Blount
 VBC467017
 17.5 cm / 7"



SQS Certificate
 ISO 9001:2000
 ISO 13485:2003

293



Orthopedic
Meniscotomy Knives
Meniskotome
Bisturios para meniscos

ارتوپدی
چاقوها



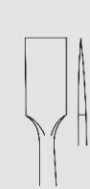
CE

SQS Certificate
ISO 9001:2000
ISO 13485:2003

294



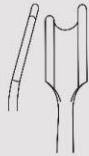
Smillie



VBC469017
17 cm / 6 3/4"



VBC469117
Curved left



VBC469217
Curved right



17 cm / 6 3/4"



VBC469517



VBC469617



Bircher
19 cm / 7 1/2"



VBC470119



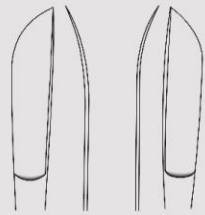
VBC470219



Salenius
VBC470522
22 cm / 8 3/4"



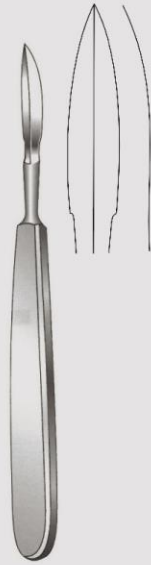
Salenius
VBC471022
22 cm / 8 3/4"



VBC471522 VBC471622



Neff
22 cm / 8 3/4"



VBC472018
18 cm / 7"



Lowe-Breck
VBC472525
25 cm / 10"



Downing
VBC473025
25 cm / 10"



Orthopedic
Meniscotomy Knives
Meniskotome
Bisturios para meniscos

ارتوپدی
چاقوها



CE

SQS Certificate
ISO 9001:2000
ISO 13485:2003

295



Orthopedic
Tendon Seizing Instruments
Sehnenfabinstrumente
Instrumentos para coger tendones

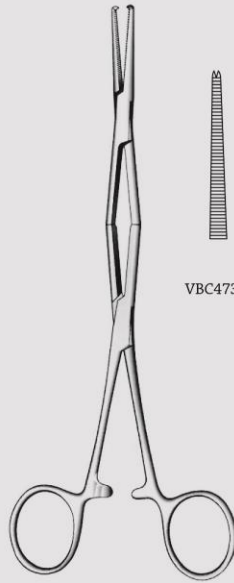
ارتوپدی
پنس ها



CE

SQS Certificate
ISO 9001:2000
ISO 13485:2003

296



20 cm / 8"



VBC473520



VBC473620



VBC475010
1.5 mm



VBC475110
2.5 mm



VBC475210
4.5 mm



VBC475310
5.5 mm



10 cm / 4"



Brand



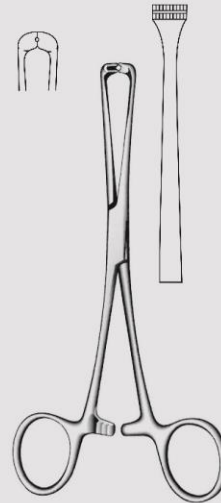
VBC474515
15 cm / 6"



VBC474519
19 cm / 7 1/2"



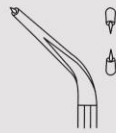
VBC474524
24 cm / 9 1/2"



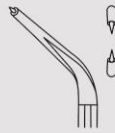
Steinmann
VBC474016
16 cm / 6 1/4"



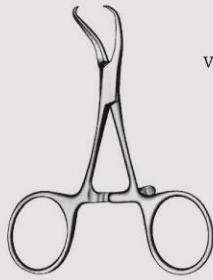
Orthopedic
Bone Holding &
Reduction Forceps
Knochenhalte-
zangen
Pinzas para huesos



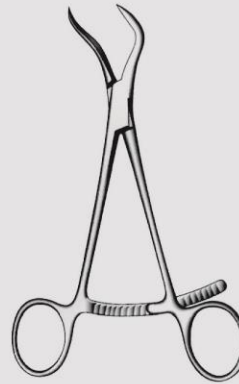
VBC475509



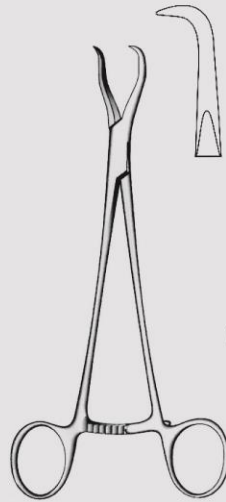
VBC475609



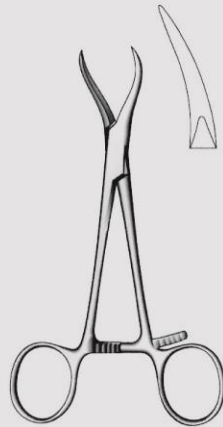
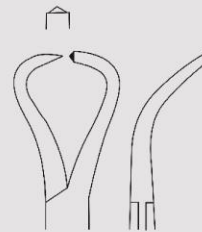
9.5 cm / 3 7/8"
Reposition forceps
with stepped tips



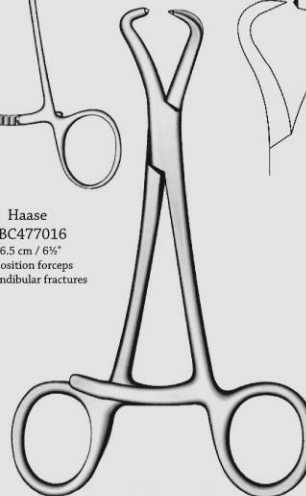
VBC476013
13.5 cm / 5 1/4"



Haase
VBC477016
16.5 cm / 6 1/2"
Reposition forceps
for mandibular fractures



VBC476513
13.5 cm / 5 1/4"
Reposition forceps,
especially for maxillary reposition



VBC477514 14 cm / 5 1/2"
VBC477516 16.5 cm / 6 1/2"
Curved
Bone reduction forceps

ارتوپدی
استخوانگیر



CE

SQS Certificate
ISO 9001:2000
ISO 13485:2003

297



Orthopedic
Bone Holding & Reduction Forceps
Knochenhaltezaugen
Pinzas para huesos

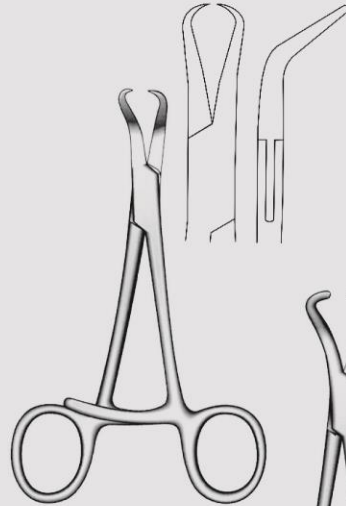
ارتوپدی
استخوانگیر



CE

SQS Certificate
ISO 9001:2000
ISO 13485:2003

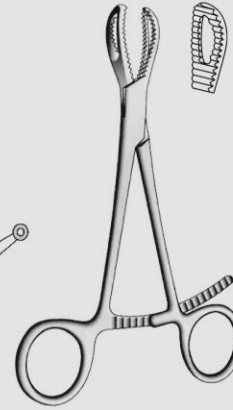
298



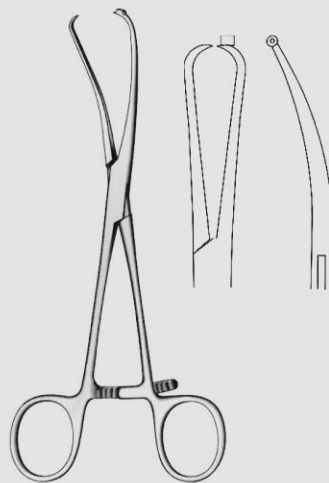
Stagbeetle
VBC478012
12 cm / 4 3/4"
Bone reduction forceps
Curved, pointed tips



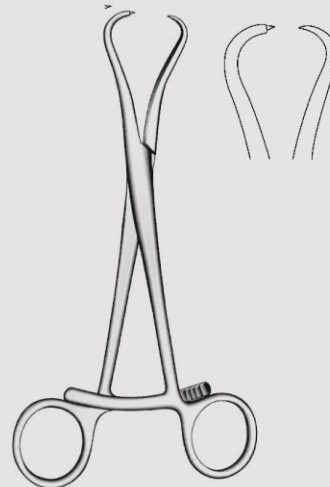
VBC478513
13 cm / 5 1/4"
Bone holding forceps
Curved, with 1.6 mm k-wire guide



VBC479000
Bone holding forceps



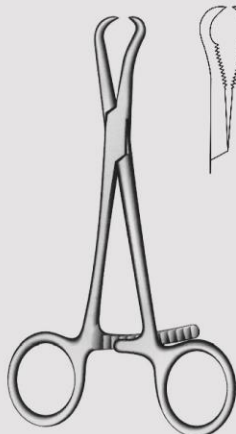
VBC479517
17 cm / 6 3/4"
Bone holding forceps
Curved, with 1.1 mm k-wire guide



VBC480015 15 cm / 6"
VBC480017 17.5 cm / 7"
VBC480020 20 cm / 8"



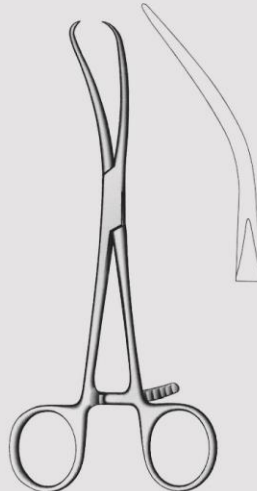
**Orthopedic
Bone Holding &
Reduction Forceps**
Knochenhalte-
zangen
Pinzas para huesos



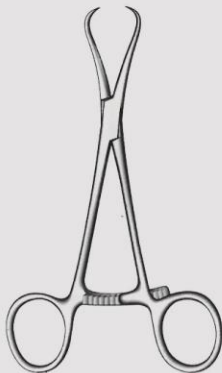
Bone holding forceps
Serrated with pointed tips
curved

VBC480512
12.5 cm / 5"

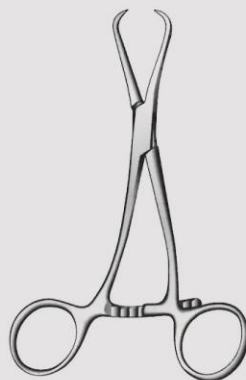
VBC480514
14 cm / 5½"



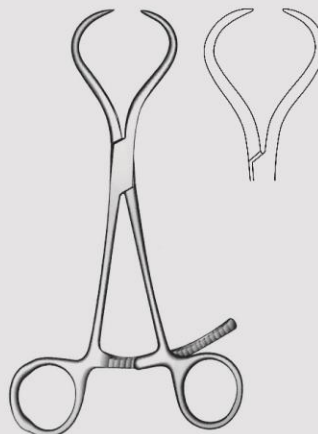
Reill
VBC481017
17.5 cm / 7"
Bone reposition forceps
curved, pointed tips



Steinhauser
VBC481513
13 cm / 5"



Steinhauser
VBC482013
13 cm / 5"



VBC482516
16 cm / 6¼"
Bone fragment forceps



CE

SQS Certificate
ISO 9001:2000
ISO 13485:2003

299



Orthopedic
Bone Holding & Reduction Forceps
Knochenhaltezaugen
Pinzas para huesos

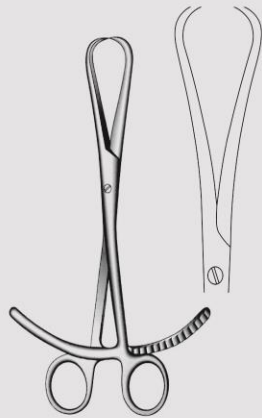
ارتوپدی
استخوانگیر



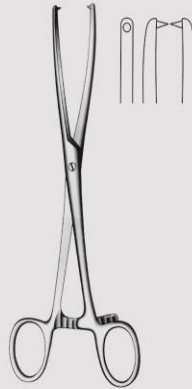
CE

SQS Certificate
ISO 9001:2000
ISO 13485:2003

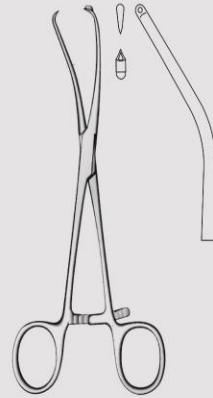
300



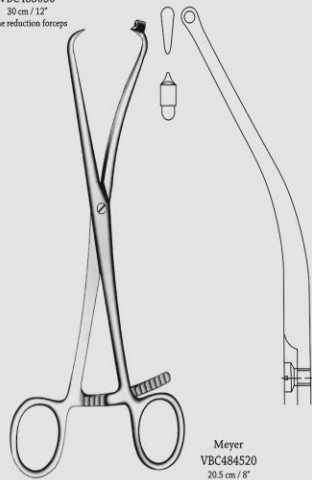
VBC483015
15 cm / 6"
VBC483018
18 cm / 7"
VBC483020
20 cm / 8"
VBC483030
30 cm / 12"
Bone reduction forceps



Malleolar
VBC483521
21 cm / 8 1/4"
1 x 1 sharp points.
Grasping forceps for small bones



Meyer
VBC484017
17 cm / 6 1/2"
Reposition forceps for gears,
with drill guide for Kirschner wires
up to diameter 1.0 mm



Meyer
VBC484520
20.5 cm / 8"
Reposition forceps
with drill guide for Kirschner
wires up to diameter 2.0 mm



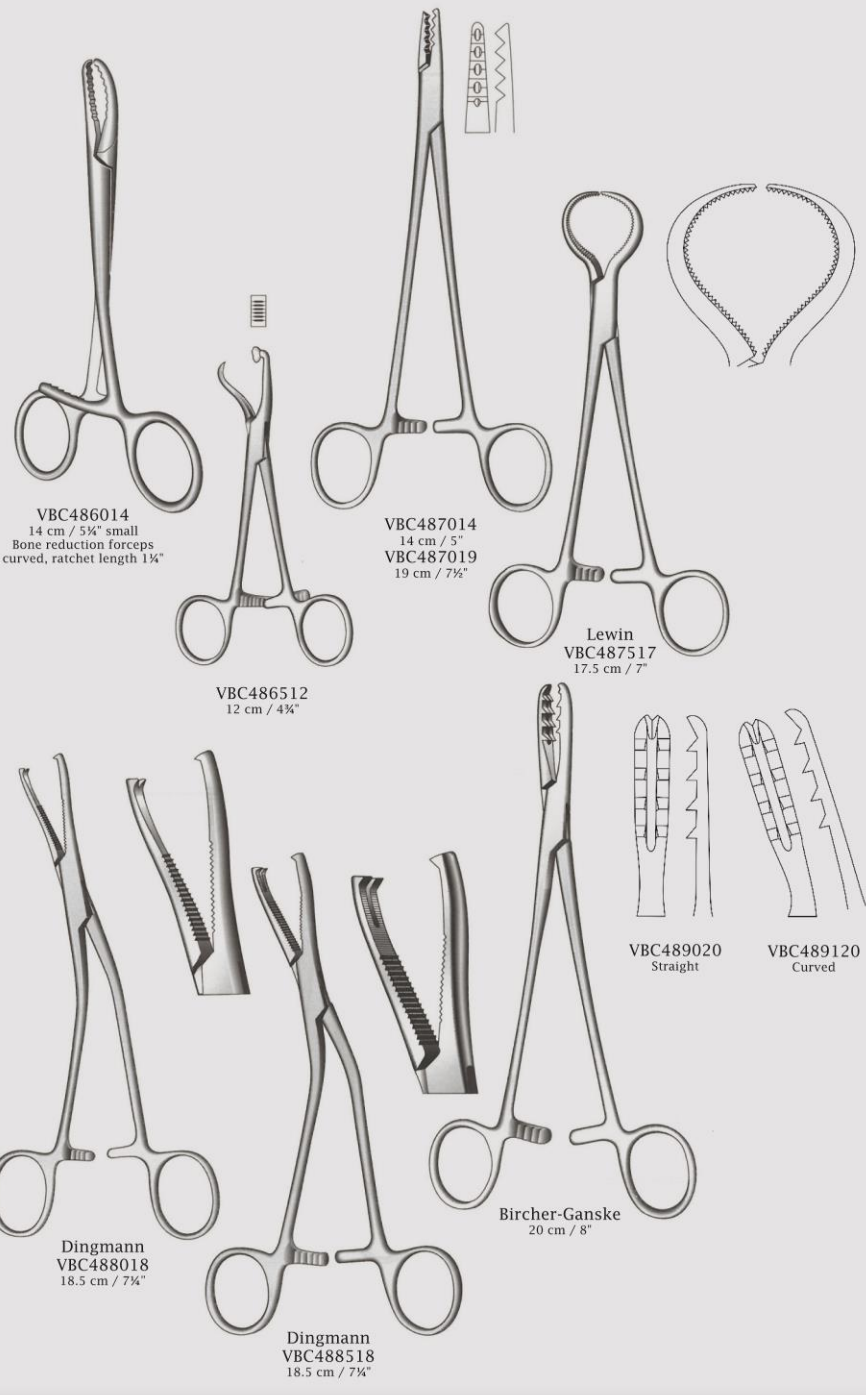
VBC485014
14 cm / 5 1/2"



Locke
VBC485515
15 cm / 6"
Phalangeal forceps serrated jaws
1:1 Teeth



Orthopedic
Bone Holding &
Reduction Forceps
Knochenhaltezaugen
Pinzas para huesos



VBC486014
14 cm / 5 1/4" small
Bone reduction forceps
curved, ratchet length 1 1/4"

VBC486512
12 cm / 4 3/4"

VBC487014
14 cm / 5"
VBC487019
19 cm / 7 1/2"

Lewin
VBC487517
17.5 cm / 7"

Dingmann
VBC488018
18.5 cm / 7 1/4"

Dingmann
VBC488518
18.5 cm / 7 1/4"

Bircher-Ganske
20 cm / 8"

VBC489020
Straight

VBC489120
Curved

ارتوپدی
استخوانگیر



CE

SQS Certificate
ISO 9001:2000
ISO 13485:2003





Orthopedic
Bone Holding & Reduction Forceps
Knochenhalteanzgen
Pinzas para Huesos

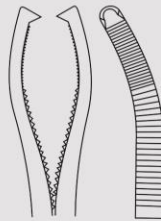
ارتوپدی
استخوانگیر



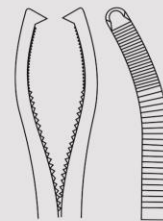
CE

SQS Certificate
ISO 9001:2000
ISO 13485:2003

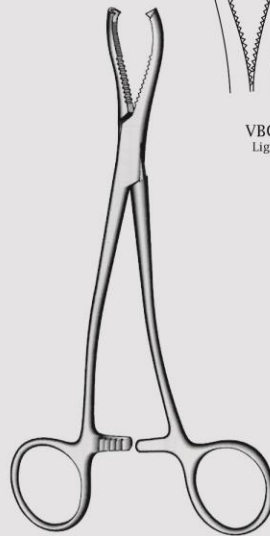
302



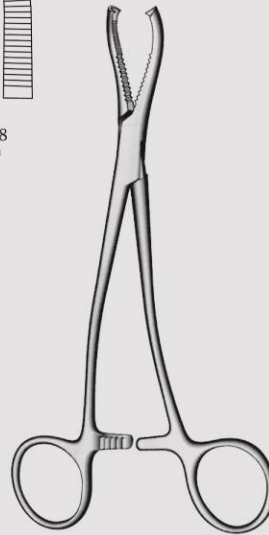
VBC489518
Light pattern



VBC490118
Heavy pattern



Jeter Van Sickle
18 cm / 7"
For sagittal split procedure



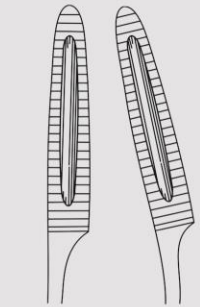
Jeter Van Sickle
18 cm / 7"
For sagittal split procedure



Orthopedic
Bone Holding Forceps
Knochenhaltezaugen
Pinzas para huesos



Requistum
20 cm / 8"



VBC490520
Straight

VBC490620
Curved



Van Buren
VBC491023
23 cm / 9"



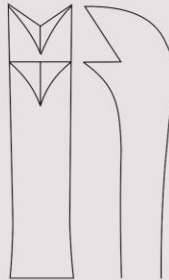
VBC491520
20 cm / 8"



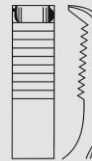
Langenbeck
VBC492021
21 cm / 8 1/4"



Fergusson
VBC492521
21 cm / 8 1/4"



Frosch
VBC493018
18 cm / 7"



ارتوپدی
استخوانگیر



CE

SQS Certificate
ISO 9001:2000
ISO 13485:2003

303



Orthopedic
Bone Holding Forceps
Knochenhaltezaugen
Pinzas para huesos

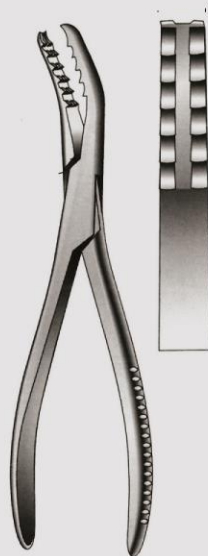
ارتوپدی
استخوانگیر



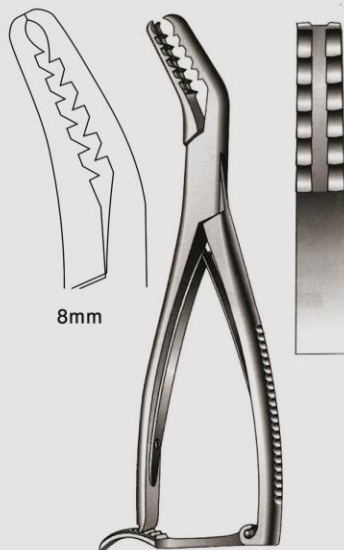
CE

SQS Certificate
ISO 9001:2000
ISO 13485:2003

304



Semb
VBC493519
19 cm / 7½"
Without ratchet



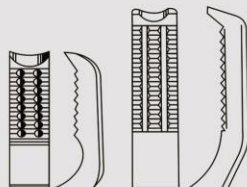
8mm

8mm

Semb
VBC494019
19 cm / 7½"
Curved sideways
VBC494020
20 cm / 8"
Deep teeth with ratchet



Kern
VBC494512 12 cm / 4¾"
VBC494515 15 cm / 6"
VBC494517 17 cm / 6¾"
VBC494521 21 cm / 8¼"
Without ratchet



Kern
VBC495012 12 cm / 4¾"
VBC495015 15 cm / 6"
VBC495017 17 cm / 6¾"
VBC495021 21 cm / 8¼"
VBC495023 23 cm / 9"
With ratchet



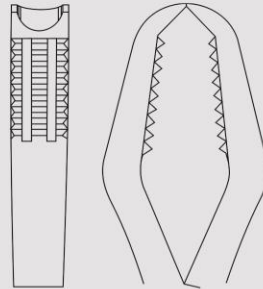
Orthopedic
Bone Holding Forceps
Knochenhaltezaugen
Pinzas para huesos

ارتوپدی
استخوانگیر

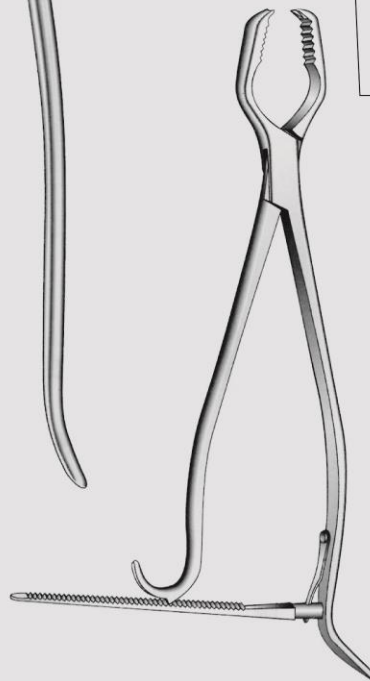
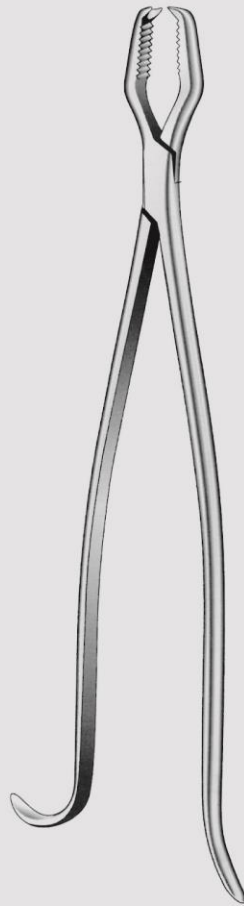
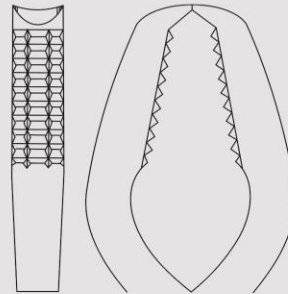


SQS Certificate
ISO 9001:2000
ISO 13485:2003

305



Lane
VBC495532
32.5 cm / 13"
Bone holding forceps
Light model, without ratchet
VBC495632
32.5 cm / 13"
Light model, with ratchet
VBC495742
42.5 cm / 17"
Without ratchet



Lane
VBC496030
30 cm / 11 3/4"
VBC496132
32.5 cm / 13"
Bone holding forceps
Standard model, without ratchet
VBC496232
32.5 cm / 13"
Standard model, with ratchet
VBC496342
42.5 cm / 17"
With ratchet



Orthopedic
Bone Holding Forceps
Knochenhaltezaugen
Pinzas para huesos

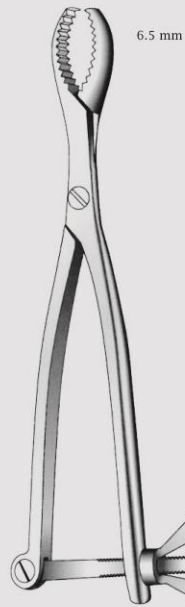
ارتوپدی
استخوانگیر



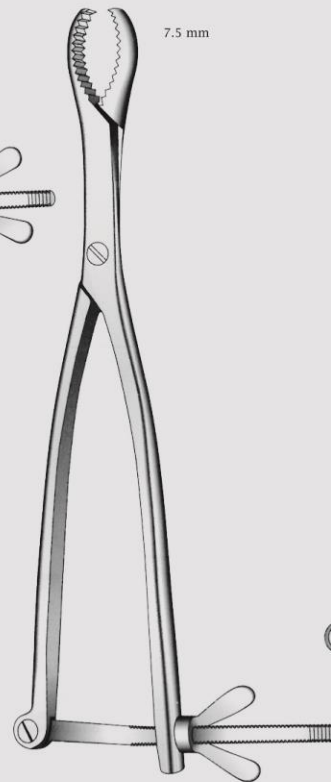
CE

SQS Certificate
ISO 9001:2000
ISO 13485:2003

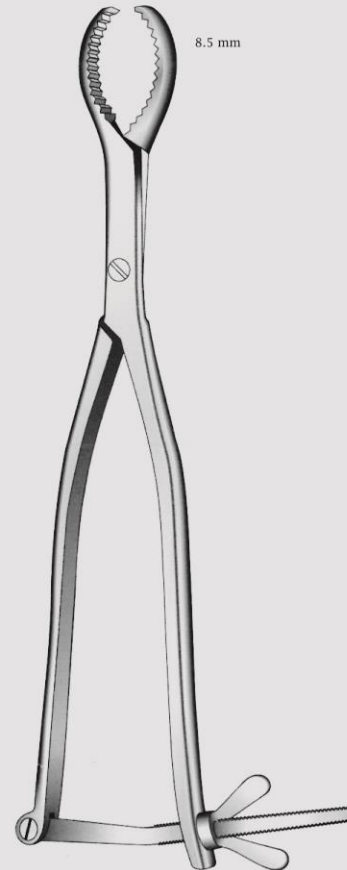
306



Hey Groves
VBC496521
21 cm / 8 1/4"



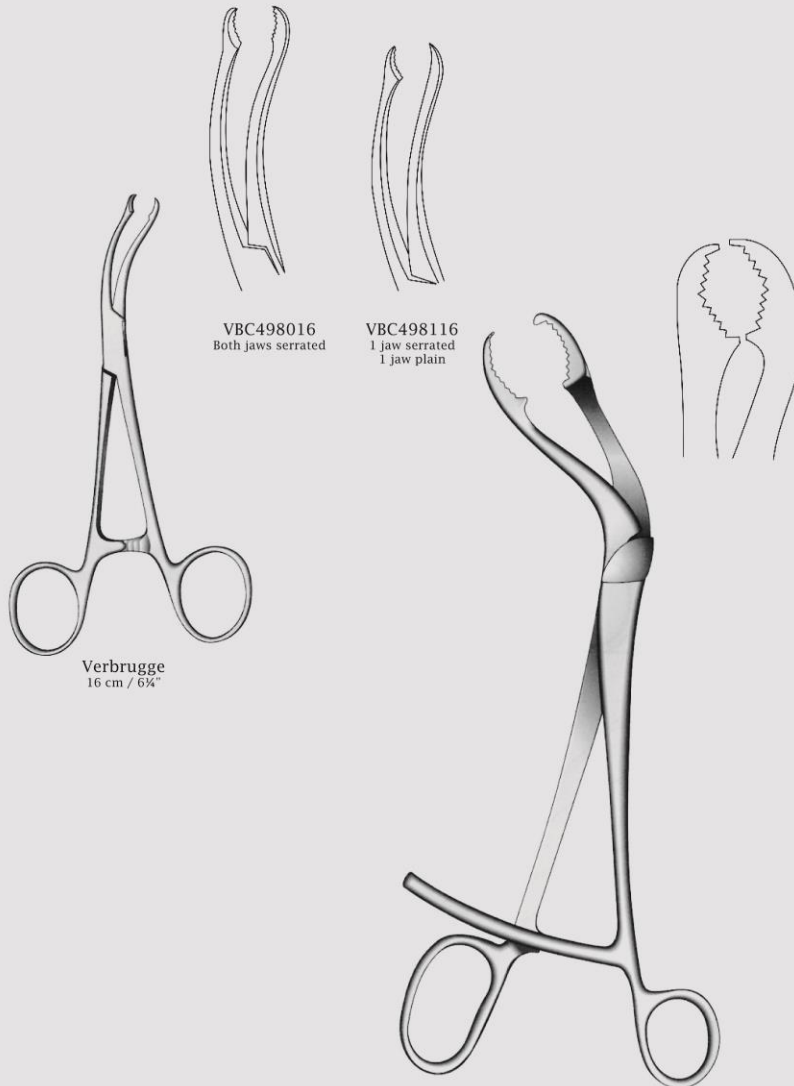
Hey Groves
VBC497025 25cm/10"
VBC497027 27cm/10 3/4"



Hey Groves
VBC497530
30.5 cm / 12"



Orthopedic
Bone Holding Forceps
Knochenhaltezaenger
Pinzas para huesos



VBC498016
Both jaws serrated

VBC498116
1 jaw serrated
1 jaw plain

Verbrugge
16 cm / 6 3/4"

Verbrugge Prehenseur
VBC498518 18cm/7"
VBC498524 24cm/9 1/2"
VBC498526 26cm/10 1/4"
VBC498528 28cm/11"
Serrated jaws

ارتوپدی
استخوانگیر



CE

SQS Certificate
ISO 9001:2000
ISO 13485:2003

307



Orthopedic
Bone Holding Forceps
Knochenhaltezangen
Pinzas para huesos

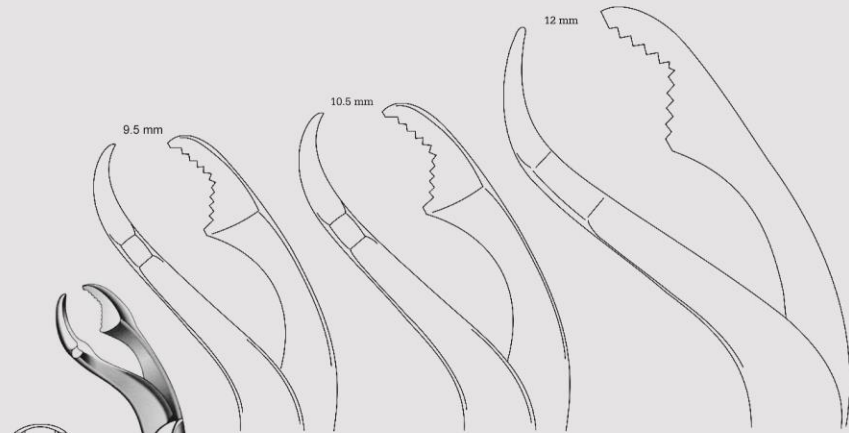
ارتوپدی
استخوانگیر



CE

SQS Certificate
ISO 9001:2000
ISO 13485:2003

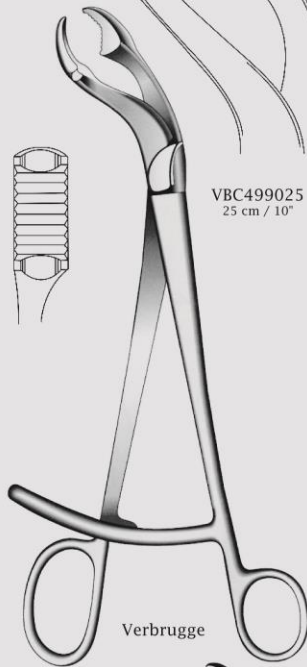
308



VBC499025
25 cm / 10"

VBC499026
26 cm / 10 1/4"

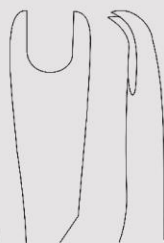
VBC499027
27 cm / 11"



Verbrugge



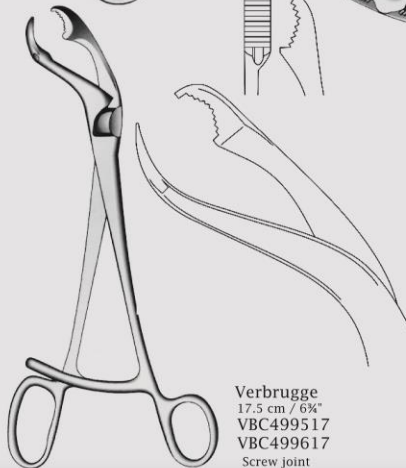
Bishop
Adjustable jaw



VBC500123 23cm/9"
VBC500132 32.5cm/13"



5 mm



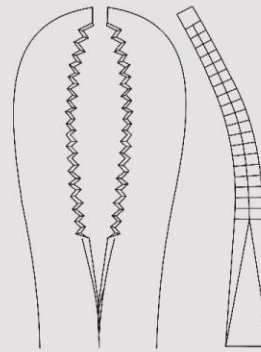
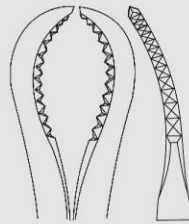
Verbrugge
17.5 cm / 6 7/8"
VBC499517
VBC499617
Screw joint



Orthopedic
Bone Holding Forceps
Knochenhaltezaugen
Pinzas para huesos

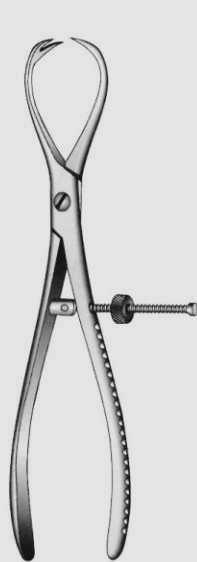


VBC500516
16 cm / 6¼"

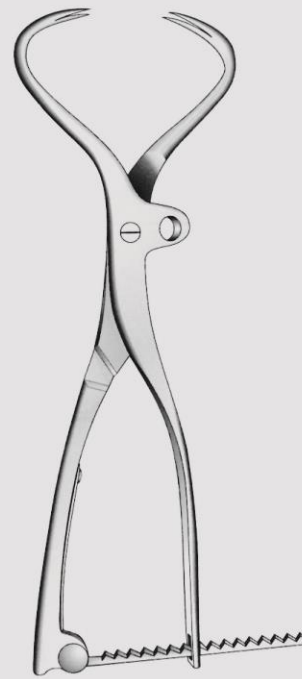
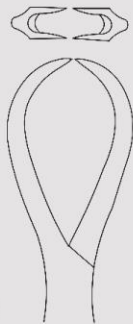


VBC500524
24 cm / 9½"

ارتوپدی
استخوانگیر



Patella Forceps
VBC501018
18 cm / 7"
2 x 2 sharp teeth
with speed lock



Ollier
VBC501519 19cm/7½"
VBC501522 22cm/8¾"
VBC501527 27cm/10¾"



CE

SQS Certificate
ISO 9001:2000
ISO 13485:2003

309



Orthopedic
Bone Holding Forceps
Knochenhaltezangen
Pinzas para huesos

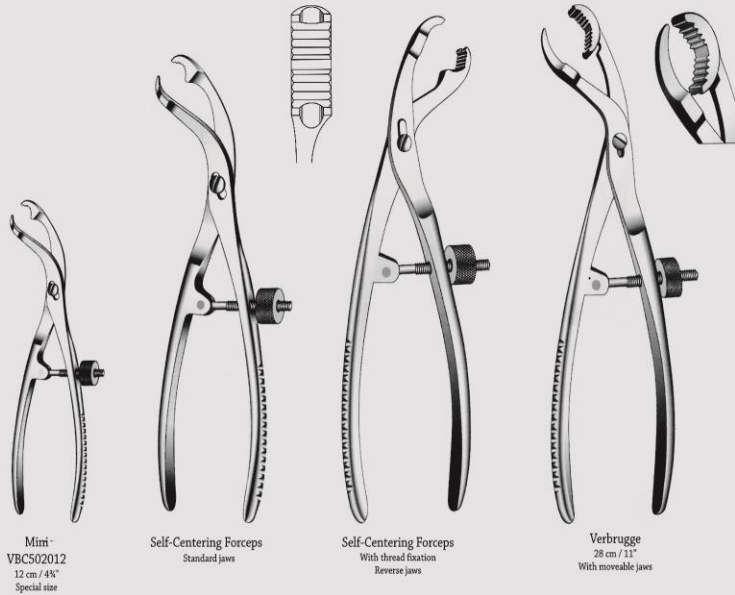
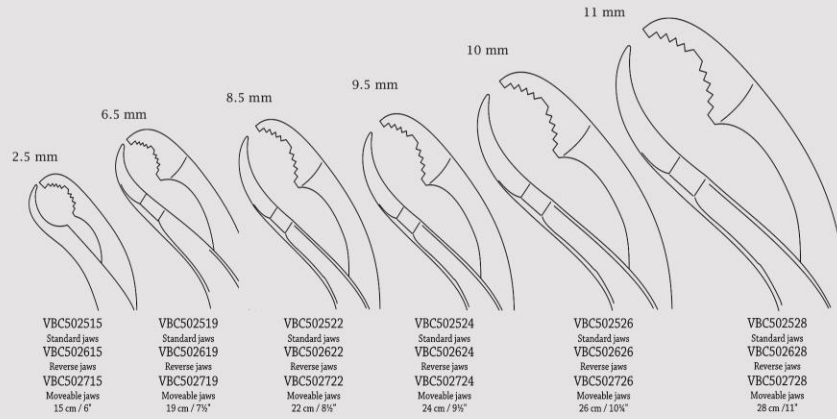
ارتوپدی
استخوانگیر



CE

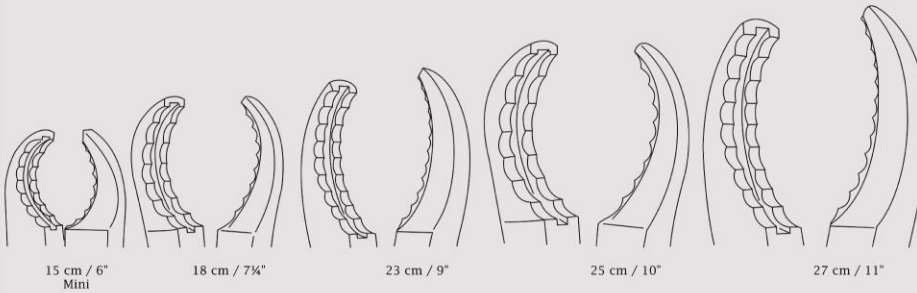
SQS Certificate
ISO 9001:2000
ISO 13485:2003

310

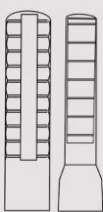




Orthopedic
Bone Holding Forceps
Knochenhaltezaugen
Pinzas para huesos



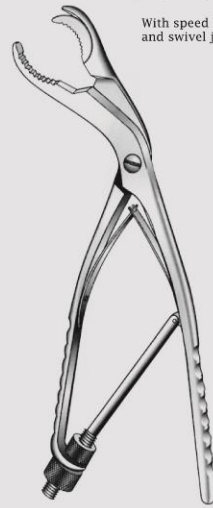
Ulrich
VBC503013 13cm/5",Mini
VBC503015 15cm/6"
VBC503018 18cm/7 1/4"
VBC503023 23cm/9"
VBC503025 25cm/10"
VBC503027 27cm/11"
Straight



Ulrich
VBC503513 13cm/5",Mini
VBC503515 15cm/6"
VBC503518 18cm/7 1/4"
VBC503523 23cm/9"
VBC503525 25cm/10"
VBC503527 27cm/11"
Angled



With speed lock
and swivel jaw



Ulrich
VBC504027
27 cm / 11"
Self-retaining forceps
angular, moveable jaw



SQS Certificate
ISO 9001:2000
ISO 13485:2003

311



Orthopedic
Bone Holding Forceps
Knochenhaltezen
Pinzas para huesos

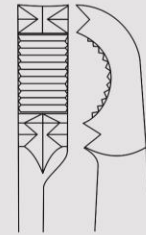
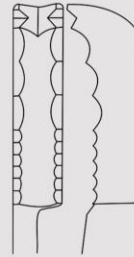
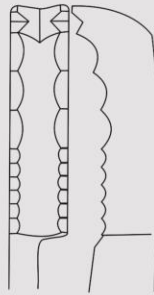
ارتوپدی
استخوانگیر



CE

SQS Certificate
ISO 9001:2000
ISO 13485:2003

312



Farabeuf Lambotte
VBC505019 19cm/7½"
VBC505023 23cm/9"
VBC505026 26cm/10¼"
Adjustable



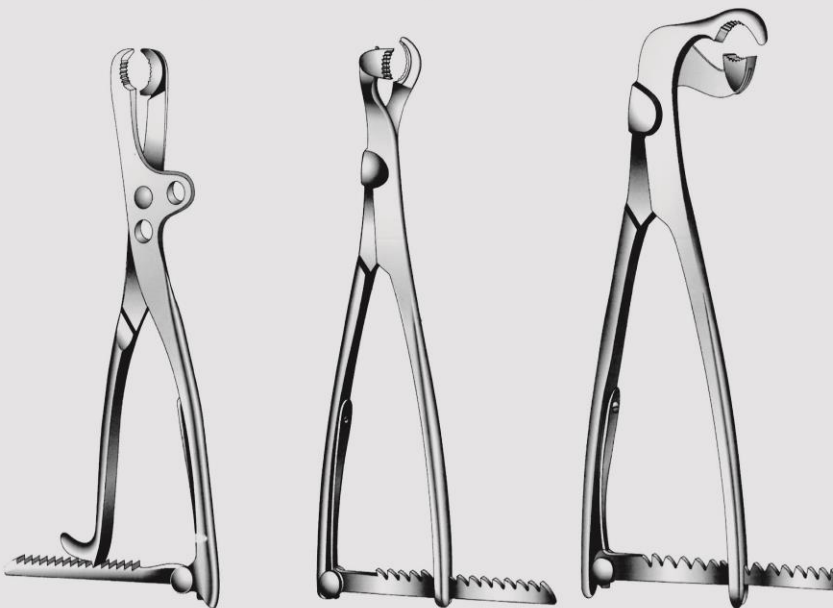
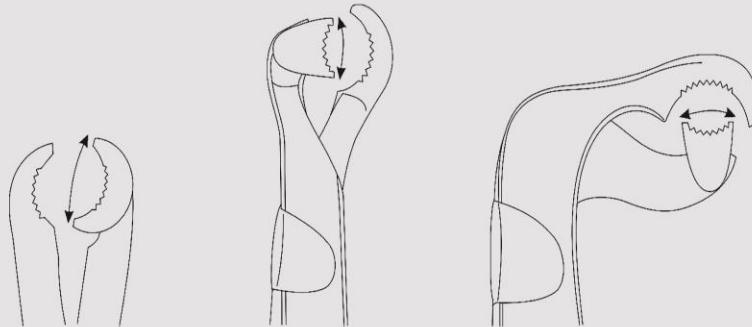
Farabeuf
VBC504519 19cm/7½"
VBC504523 23cm/9"
VBC504526 26cm/10¼"
Adjustable



Tuffier
VBC505527
27 cm / 10½"
Adjustable



Orthopedic
Bone Holding Forceps
Knochenhaltezaugen
Pinzas para huesos



Lambotte
VBC506022 22 cm / 8 1/2"
VBC506027 27 cm / 10 1/2"
VBC506030 30 cm / 12"
Adjustable

Lambotte
VBC506522 22 cm / 8 1/2"
VBC506526 26 cm / 10 1/4"
VBC506533 33 cm / 13"

Lambotte
VBC507019 19 cm / 7 1/2"
VBC507023 23 cm / 9"
VBC507026 26 cm / 10 1/4"

ارتوپدی
استخوانگیر



CE

SQS Certificate
ISO 9001:2000
ISO 13485:2003

313



Orthopedic
Bone Holding Clamps, Traction Bar
Knochenhalteklammern, Distractionsklammer
Pinzas porta huesos, Barra de traccion

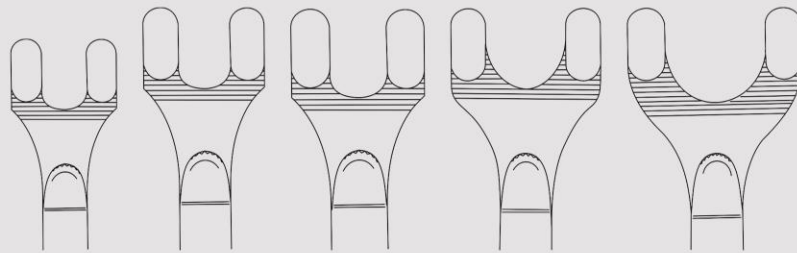
ارتوپدی
استخوانگیر

ایزر جراحی
دایموند

CE

SQS Certificate
ISO 9001:2000
ISO 13485:2003

314



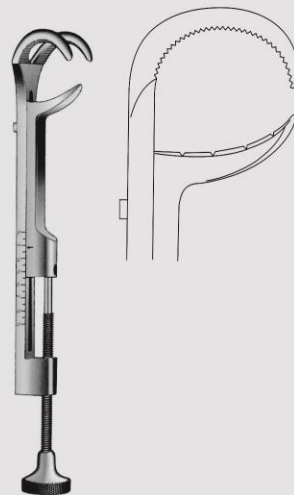
VBC507508
8.5 cm / 3 1/4"
Special mini

VBC507512
12 cm / 4 3/4"

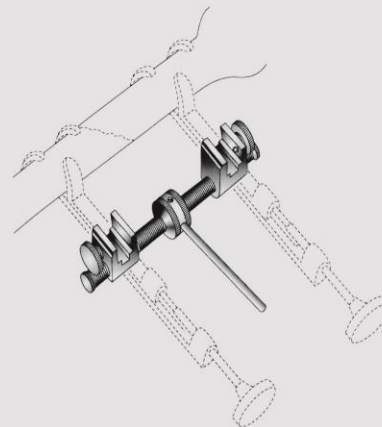
VBC507518
18 cm / 7"

VBC507520
20 cm / 8"

VBC507522
22 cm / 8 3/4"



Gerster - Lowmann
1 x 2 jaws



Gerster
VBC508000



Orthopedic
Bone Holding Clamps
Knochenhalteklammern
Pinzas porta huesos



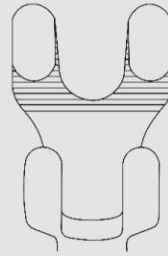
VBC508512
12 cm / 4 3/4"



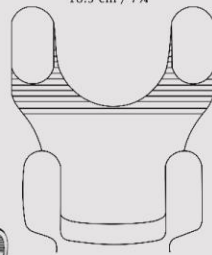
VBC508518
18 cm / 7 1/4"



VBC508520
20 cm / 8"



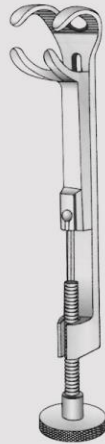
VBC509018
18.5 cm / 7 3/8"



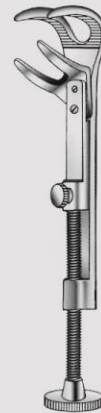
VBC509020
20 cm / 8"



Lowmann
Bone clamp
1 x 1 jaws



Lowmann
Bone clamp
2 x 2 jaws



Lowman Hoglund
VBC509512 12cm / 4 3/4"
VBC509518 18cm / 7 1/4"
VBC509520 20cm / 8"
Moveable jaws

ارتوپدی
استخوانگیر

ایزاد جراحی
دایموند

CE

SQS Certificate
ISO 9001:2000
ISO 13485:2003

315



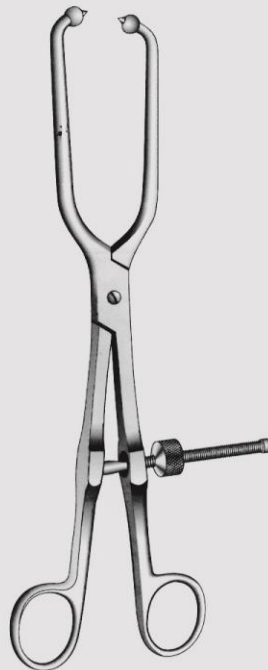
Orthopedic
Pelvic Reposition Forceps

ارتوپدی
استخوانگیر

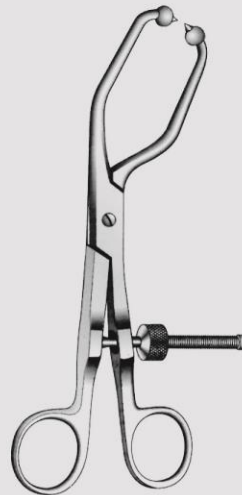


CE
SQS Certificate
ISO 9001:2000
ISO 13485:2003

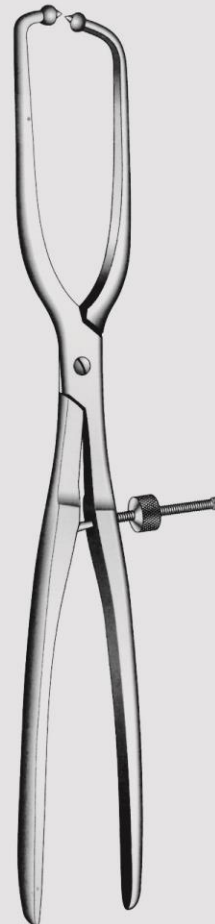
316



VBC510119 19cm/7½"
VBC510123 23cm/9"
VBC510125 25cm/10"



VBC510523 23cm/9"
VBC510525 25cm/10"

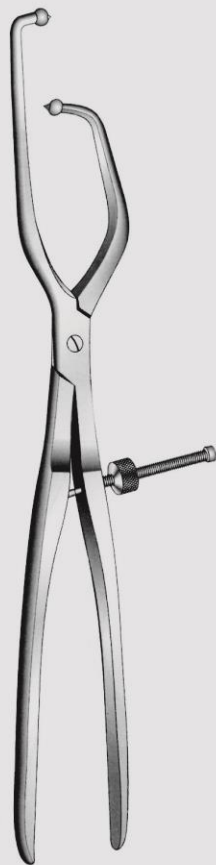


VBC511040
40 cm / 16"



Orthopedic
Pelvic Reposition Forceps

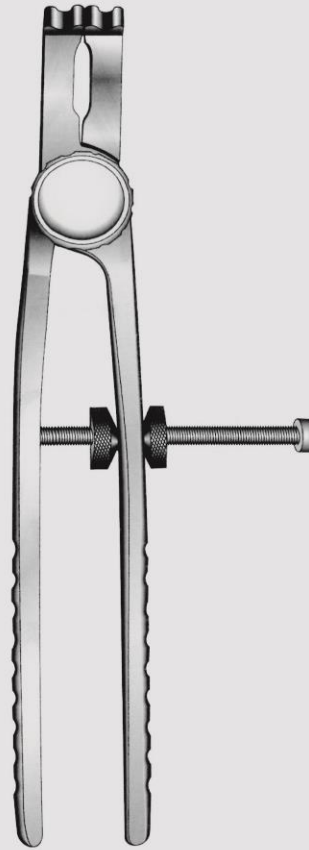
ارتوپدی
استخوانگیر



VBC511540
40 cm / 16"



VBC512040
40 cm / 16"



VBC512500
Reposition forceps
A new shifting technique permits
adjusting of the holding area within
seconds and without dismantling
the instrument.
Easy and quick fixation in both
direction by means of 2 nuts



CE

SQS Certificate
ISO 9001:2000
ISO 13485:2003

317



Orthopedic
 Bone Rongeur Forceps
 Hohlmeißelzangen
 Pinzas-gubias

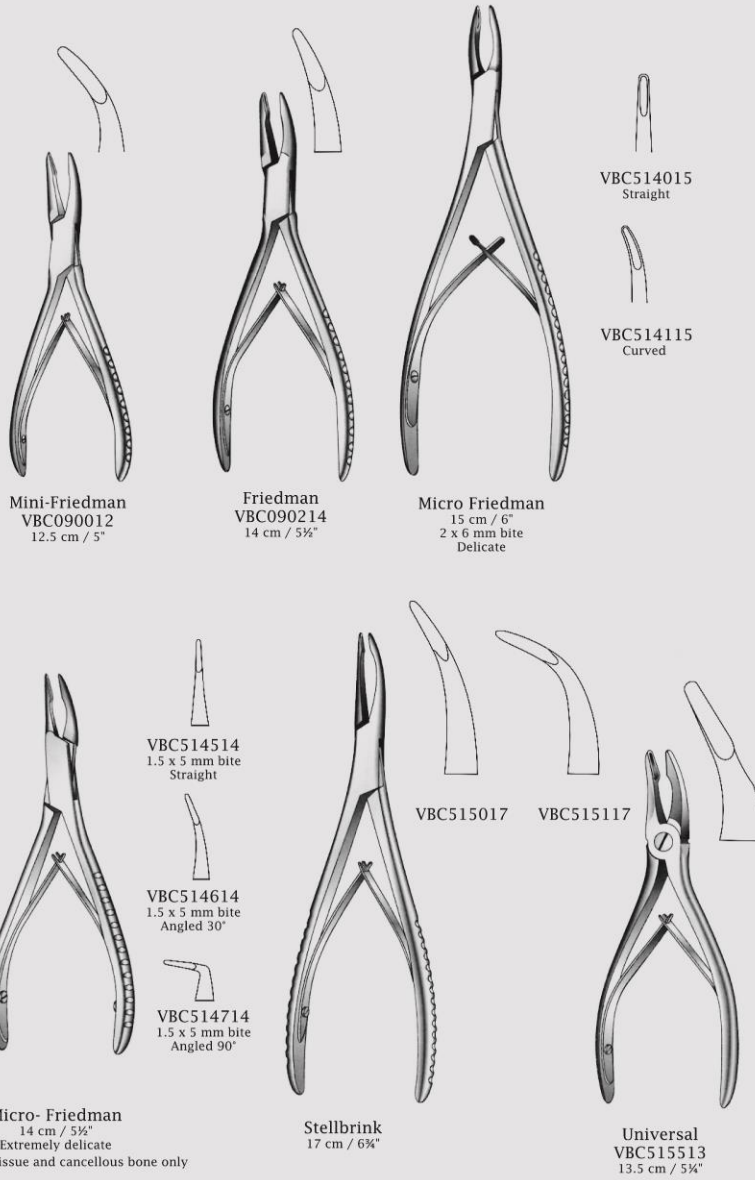
ارتوپدی
 بن رانزور



CE

SQS Certificate
 ISO 9001:2000
 ISO 13485:2003

318





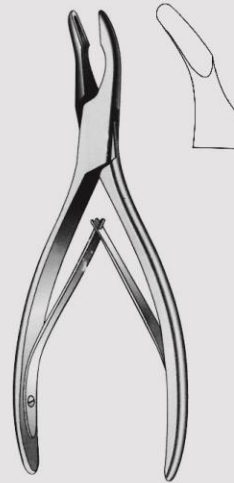
Orthopedic
Bone Rongeur Forceps
Hohlmeißelzangen
Pinzas-gubias



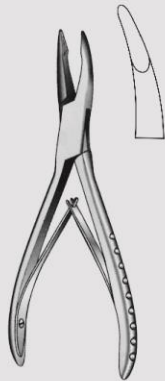
Mead
VBC516016
16.5 cm / 6½"



Mead
VBC516516
16.5 cm / 6½"



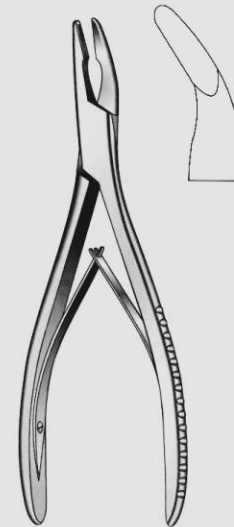
Mead
VBC517016
16.5 cm / 6½"



Cleveland
VBC090614
14.5 cm / 5½"



Cleveland
VBC090817
17 cm / 6¾"



Hartmann
VBC092018
18.5 cm / 7¼"

ارتوپدی
بن رانژور



CE

SQS Certificate
ISO 9001:2000
ISO 13485:2003

319



Orthopedic
Bone Rongeur Forceps
Hohlmeißelzangen
Pinzas-gubias

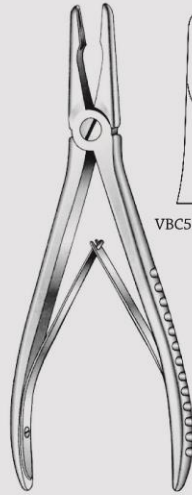
ارتوپدی
بن رانژور



CE

SQS Certificate
ISO 9001:2000
ISO 13485:2003

320



Jansen
18 cm / 7"



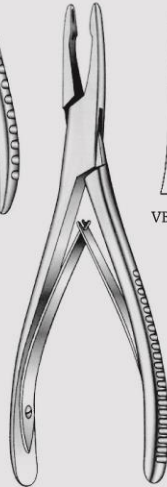
VBC517518



VBC517618



VBC517718



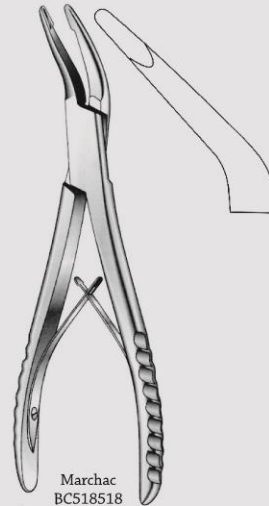
Jansen
18 cm / 7"



VBC518018



VBC518118



Marchac
BC518518
18 cm / 7"



VBC093615



VBC093815



VBC094015



VBC095415



VBC096515



VBC096615



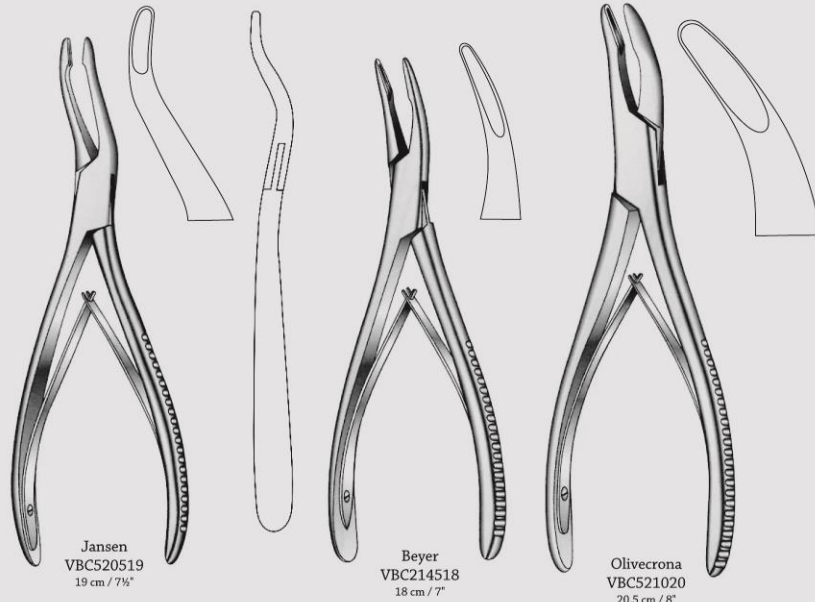
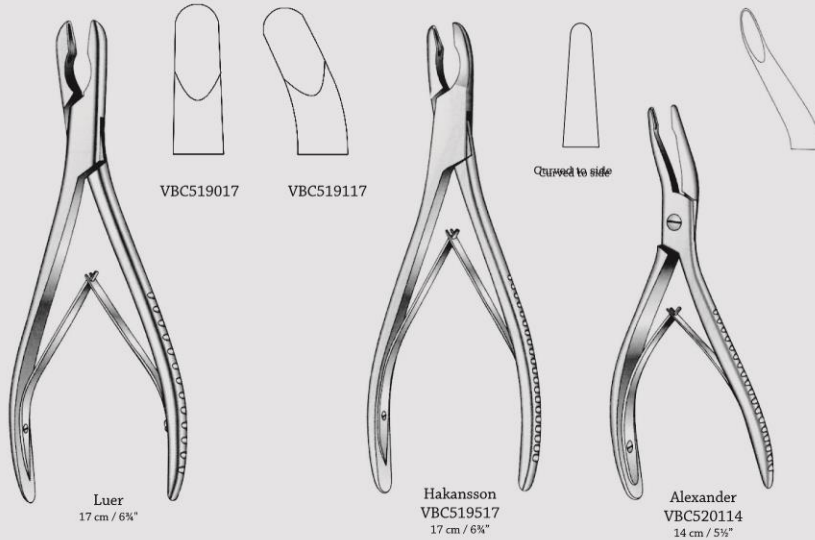
Blumenthal
15 cm / 6"



Luer
15 cm / 6"



Orthopedic
Bone Rongeur Forceps
HohlmeiBelzangen
Pinzas-gubias



ارتوپدی
بن رانژور



CE

SQS Certificate
ISO 9001:2000
ISO 13485:2003

321



Orthopedic
Bone Rongeur Forceps
Hohlmeißelzangen
Pinzas-gubias

ارتوپدی
بن رانزور



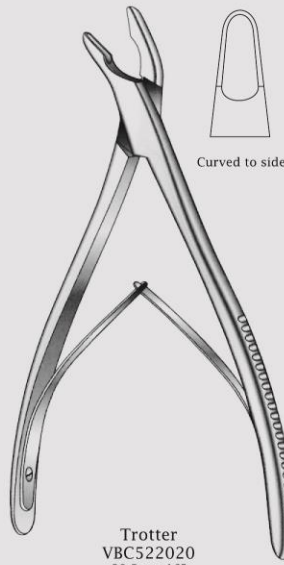
CE

SQS Certificate
ISO 9001:2000
ISO 13485:2003

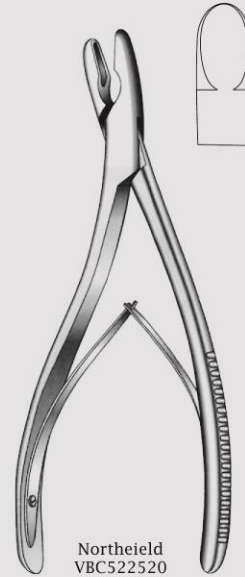
322



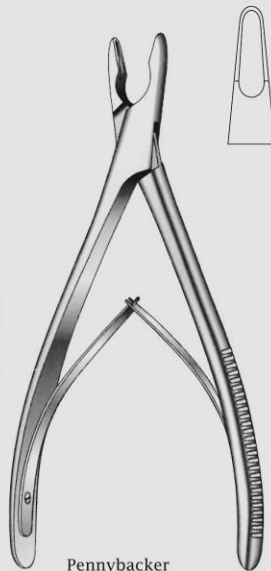
Guleke
VBC521520
20.5 cm / 8"



Trotter
VBC522020
20.5 cm / 8"



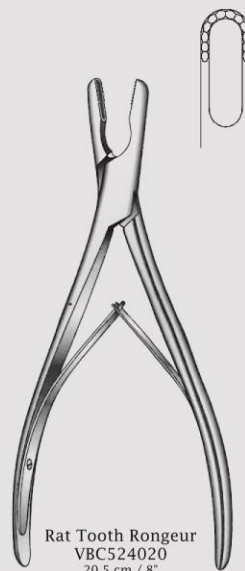
Northeield
VBC522520
20.5 cm / 8 1/4"



Pennybacker
VBC523020
20.5 cm / 8"



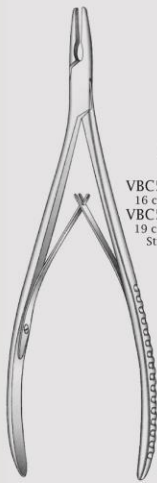
Wilms
VBC523521
21 cm / 8 1/4"



Rat Tooth Rongeur
VBC524020
20.5 cm / 8"
With teeth 8 x 15 mm bite
Straight



Orthopedic
Bone Rongeur Forceps
HohlmeiBelzangen
Pinzas-gubias



Lempert
2.5 mm bite

VBC524516
16 cm / 6¼"
VBC524519
19 cm / 7½"
Straight

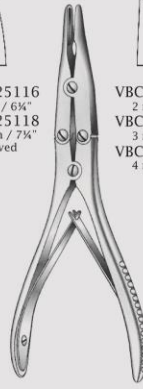
VBC524616
16 cm / 6¼"
VBC524619
19 cm / 7½"
Curved



Juers-Lempert
Straight jaws on curved handles, delicate, 2.5 mm bite

VBC525016
16 cm / 6¼"
VBC525018
18.5 cm / 7¼"
Straight

VBC525116
16 cm / 6¼"
VBC525118
18.5 cm / 7¼"
Curved



Bohler
15 cm / 6"

VBC525515
2 mm tip
VBC525615
3 mm tip
VBC525715
4 mm tip

VBC526015
2 mm tip
VBC526115
3 mm tip
VBC526215
4 mm tip



Zaufal-Jansen
VBC098018
18 cm / 7"



Mayfield
VBC526517
17 cm / 6¾"



Beyer
18 cm / 7"

VBC527018
Straight
VBC527118
Curved



Ruskin
Delicate

VBC215015 2 mm
VBC527515 3 mm
VBC527615 4 mm
15 cm / 6"

VBC528018 2 mm
VBC215518 3 mm
VBC528118 4 mm
VBC528218 6 mm
VBC528318 8 mm
17.5 cm / 7"

VBC528520 2 mm
VBC528620 3 mm
VBC528720 4 mm
VBC528820 6 mm
VBC528920 8 mm
20 cm / 8"
Straight

VBC529515 2 mm
VBC529615 3 mm
VBC529715 4 mm
15 cm / 6"

VBC530018 2 mm
VBC098818 3 mm
VBC530118 4 mm
VBC530218 6 mm
VBC530318 8 mm
17.5 cm / 7"

VBC530520 2 mm
VBC530620 3 mm
VBC530720 4 mm
VBC530820 6 mm
VBC530920 8 mm
20 cm / 8"
Curved



SQS Certificate
ISO 9001:2000
ISO 13485:2003

323



Orthopedic
Bone Rongeur Forceps
Hohlmeißelzangen
Pinzas-gubias

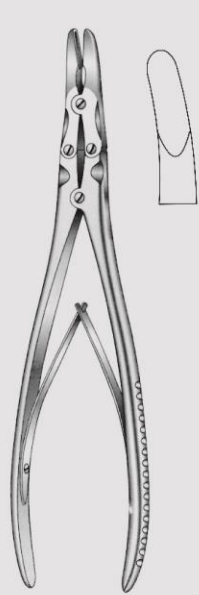
ارتوپدی
بن رانزور



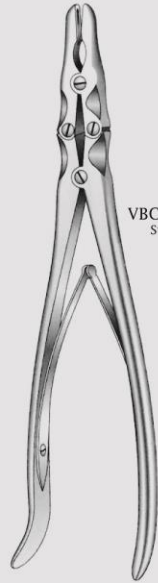
CE

SQS Certificate
ISO 9001:2000
ISO 13485:2003

324

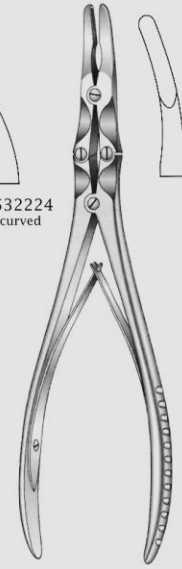


Ruskin
VBC531523
23 cm / 9"



Smith-Peterson
24 cm / 9 1/2"
3 x 16 mm bite
Laminectomy rongeur

VBC532024 VBC532124 VBC532224
Straight Curved Full curved



Marquard
VBC532520
20 cm / 8"



Kleinert-Kutz
15 cm / 6"
Synovectomy rongeur
Slight curve, delicate

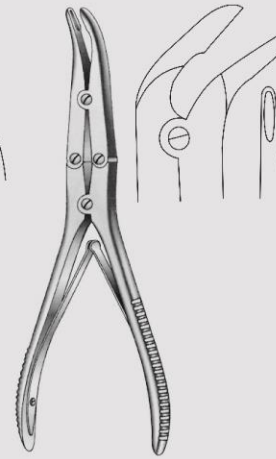
VBC533015
2 x 13 mm bite



VBC533115
3 x 13 mm bite



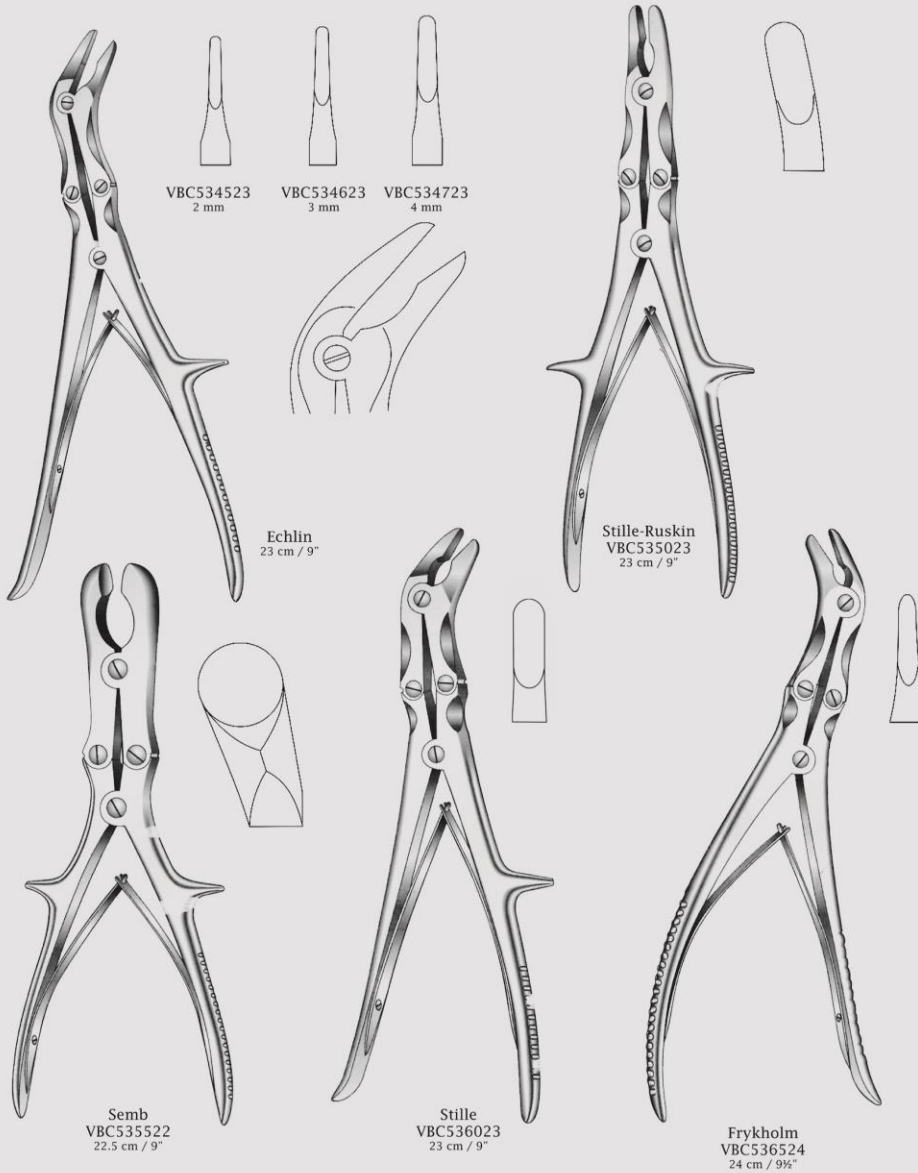
VBC533515
15 cm / 6"
3 x 8 mm bite
Full curved
Delicate



Kleinert-Kutz
VBC534015
15 cm / 6"
2 x 10 mm bite
Synovectomy rongeur
Curved on side
Delicate



Orthopedic
Bone Rongeur Forceps
Hohlmeißelzangen
Pinzas-gubias



ارتوپدی
بن رانژور



CE

SQS Certificate
ISO 9001:2000
ISO 13485:2003





Orthopedic
Bone Rongeur Forceps
Hohlmeißelzangen
Pinzas-gubias

ارتوپدی
استخوانگیر



CE

SQS Certificate
ISO 9001:2000
ISO 13485:2003

326



Leksell-Stille
24 cm / 9 1/2"
Curved 1°



VBC537024
3 x 16 mm bite



VBC537124
4 x 16 mm bite



VBC537224
5 x 16 mm bite



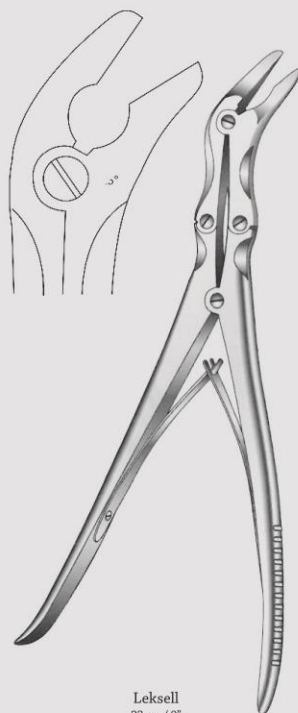
VBC537324
6 x 16 mm bite



VBC537424
7 x 16 mm bite



VBC537524
8 x 16 mm bite



Leksell
23 cm / 9"
Curved 50°



VBC538023
3 x 13 mm bite



VBC538123
4 x 13 mm bite



VBC538223
5 x 13 mm bite



VBC538323
6 x 13 mm bite



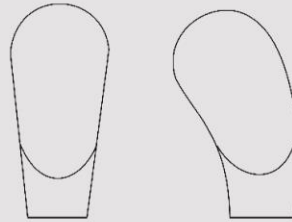
VBC538423
7 x 13 mm bite



VBC538523
8 x 13 mm bite



Orthopedic
Bone Rongeur Forceps
HohlmeiBelzangen
Pinzas-gubias

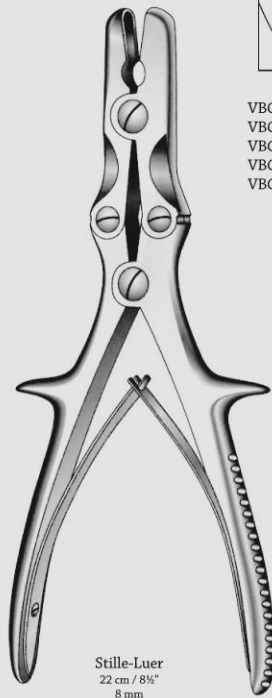


VBC540123 23 cm / 9" VBC540223
VBC540127 27 cm / 10 1/2" VBC540227

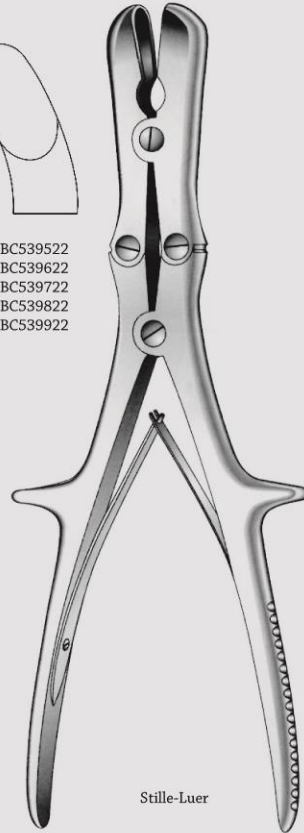


VBC539022 4 mm
VBC539122 6 mm
VBC539222 8 mm
VBC539322 10 mm
VBC539422 12 mm

VBC539522
VBC539622
VBC539722
VBC539822
VBC539922



Stille-Luer
22 cm / 8 1/2"
8 mm



Stille-Luer

ارتوپدی
بن رانژور



CE

SQS Certificate
ISO 9001:2000
ISO 13485:2003

327



Orthopedic
Bone Rongeur Forceps
Hohlmeißelzangen
Pinzas-gubias

ارتوپدی
بن رانزور



CE

SQS Certificate
ISO 9001:2000
ISO 13485:2003

328



VBC540530



VBC540630



VBC541036
3 mm



VBC541136
5 mm



VBC541236
6 mm



VBC541336
8 mm



VBC541500
3 mm



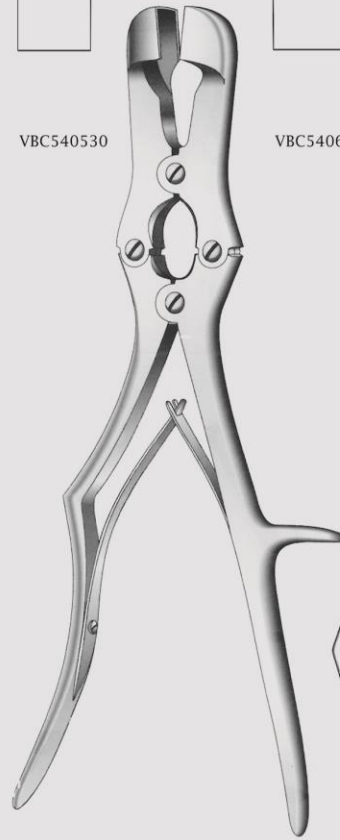
VBC541600
5 mm



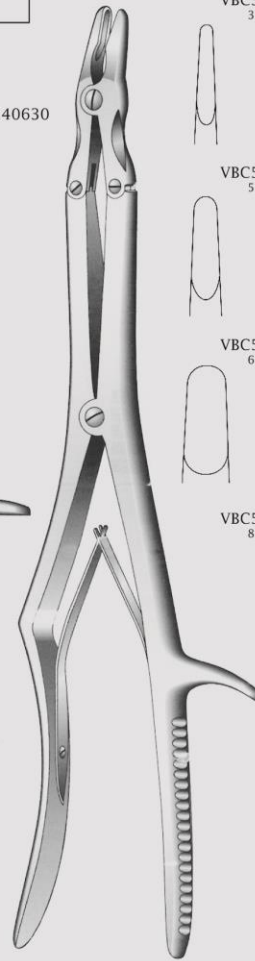
VBC541700
6 mm



VBC541800
8 mm



Sauerbruch
30 cm / 12"



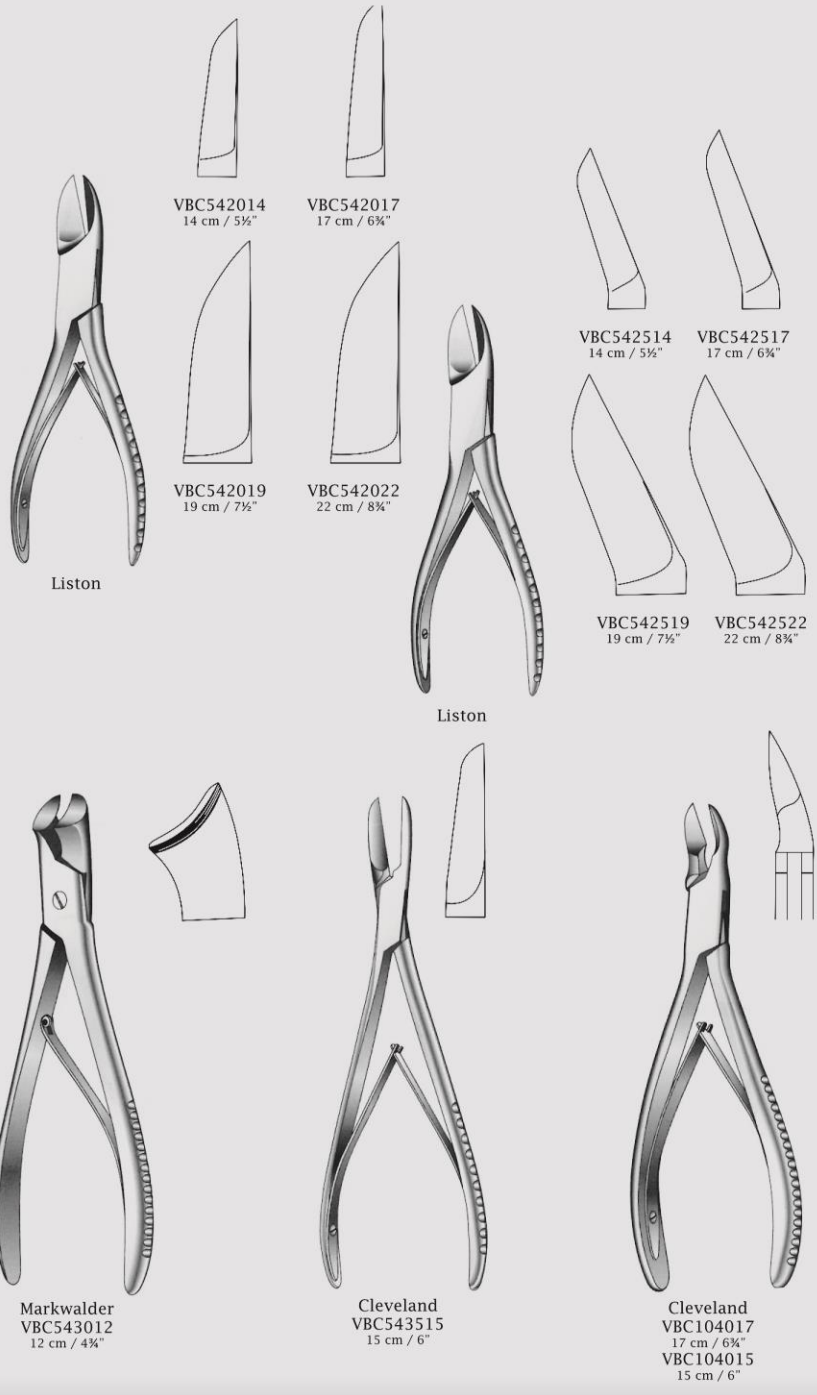
Syvert
36 cm / 14 1/2"



Dale



Orthopedic
 Bone Cutting Forceps
 Knochensplitterzangen
 Pinzas cortantes para huesos



ارتوپدی
 بن کاتر



CE

SQS Certificate
 ISO 9001:2000
 ISO 13485:2003

329



Orthopedic
Bone Cutting Forceps
Knochensplitterzangen
Pinzas cortantes para huesos

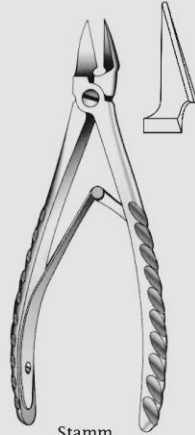
ارتوپدی
بن کانر



CE

SQS Certificate
ISO 9001:2000
ISO 13485:2003

330



Stamm
VBC544015
15 cm / 6"



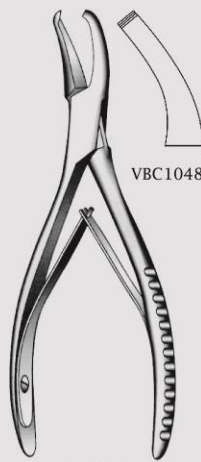
Kazanjian
VBC544518
18.5 cm / 7 1/4"



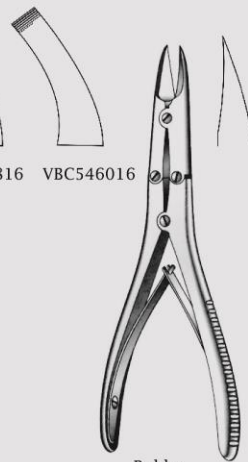
Tessier
VBC545020
20.5 cm / 8"
Slim pattern



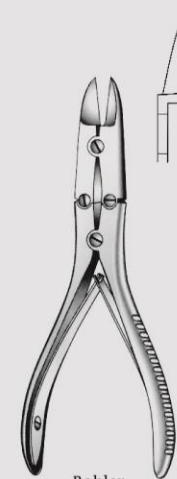
Markwalder
VBC545520
20 cm / 8"



Cleveland
16 cm / 6 1/4"



Bohler
VBC546515
15 cm / 5 3/4"



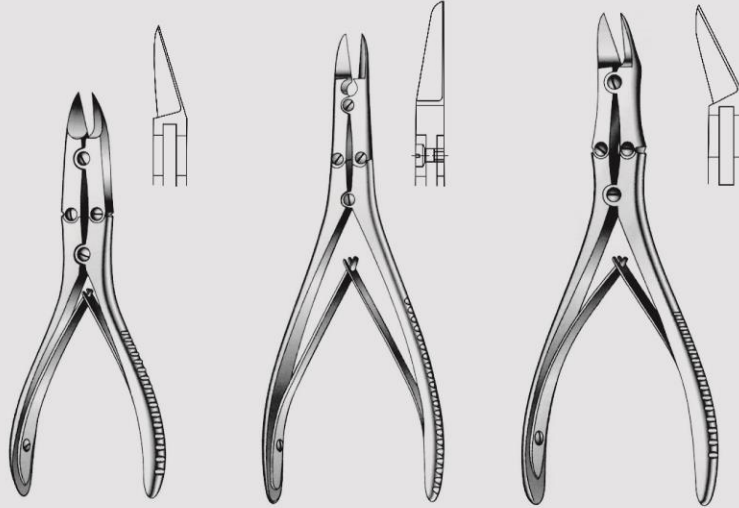
Bohler
VBC547014
14.5 cm / 5 3/4"



Velpeau
VBC547524
24 cm / 9 1/2"



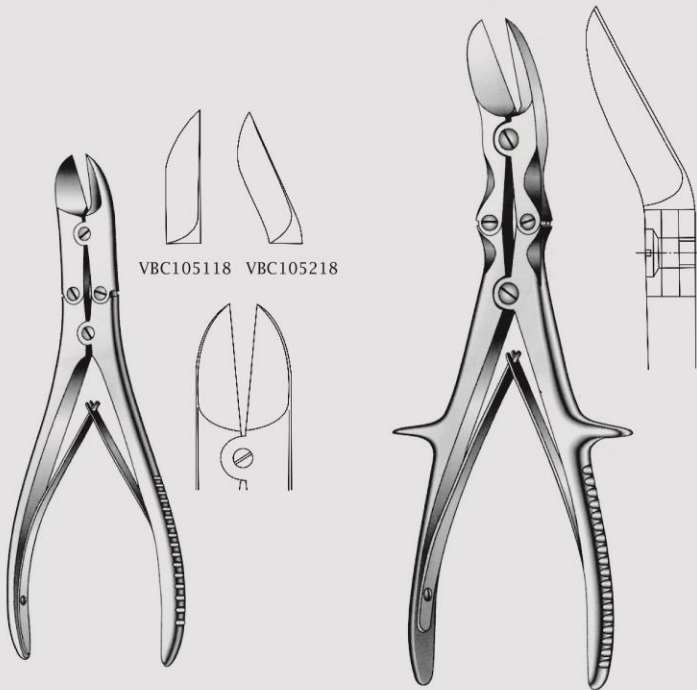
Orthopedic
Bone Cutting Forceps
Knochensplitterzangen
Pinzas cortantes para huesos



Bohler
VBC548014
14.5 cm / 5 7/8"

VBC548517
17 cm / 6 3/4"

Mc Indoe
VBC549017
17.5 cm / 7"



VBC105118 VBC105218

Ruskin-Liston
18.5 cm / 7 1/2"

Liston
VBC549524
24 cm / 9 1/2"

ارتوپدی
بن کاتر



CE

SQS Certificate
ISO 9001:2000
ISO 13485:2003

331



Orthopedic
Bone Rongeur Forceps
HohlmeiBelzangen
Pinzas-gubias

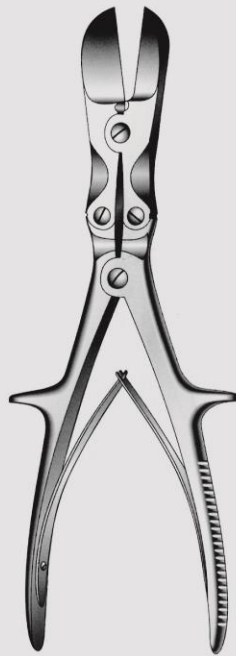
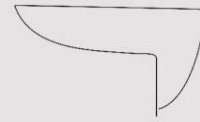
ارتوپدی
بن کاتر



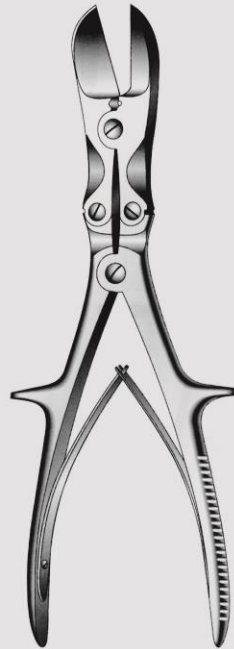
CE

SQS Certificate
ISO 9001:2000
ISO 13485:2003

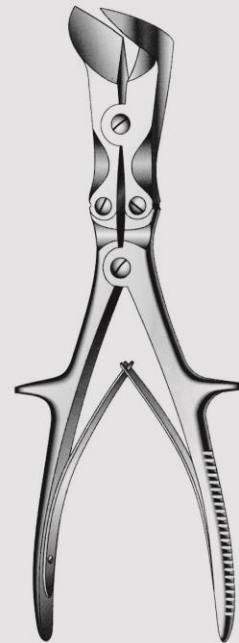
332



Stille-Liston
VBC550127
27 cm / 10 5/8"



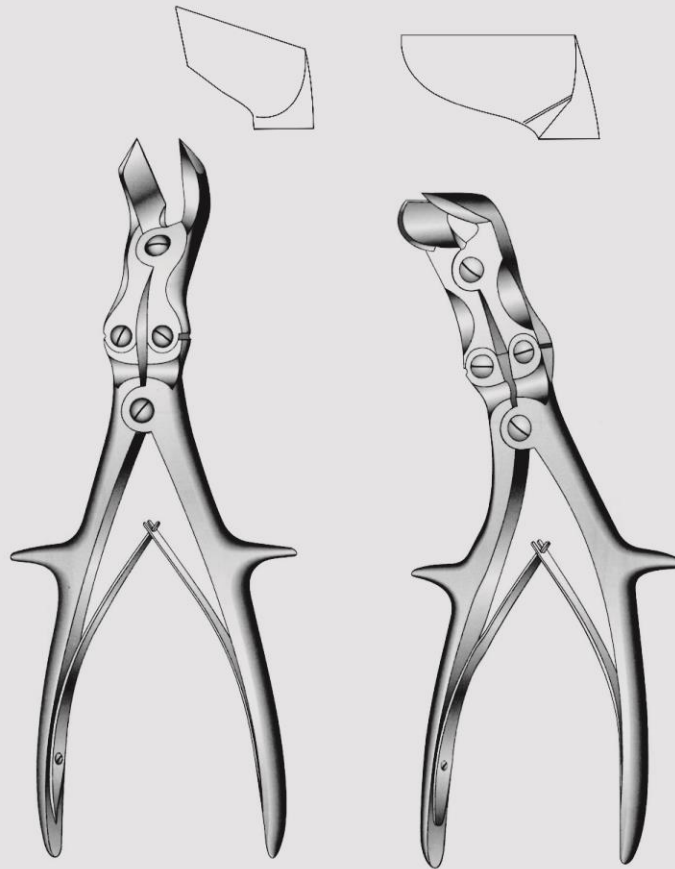
Stille-Liston
VBC550527
27 cm / 10 5/8"



Stille-Liston
VBC551027
27 cm / 10 5/8"



Orthopedic
Bone Cutting Forceps
Knochensplitterzangen
Pinzas cortantes para huesos



Liston-Key
VBC551527
27 cm / 10 1/2"

Semb
VBC552024
24 cm / 9 1/2"

ارتوپدی
بن کاتر



CE

SQS Certificate
ISO 9001:2000
ISO 13485:2003

333



Orthopedic
Wire Twisting Forceps
Draht-Zangen
Pinzas para torcer hilos

ارتوپدی
سیم گیر

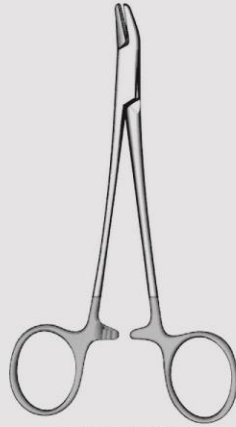


CE

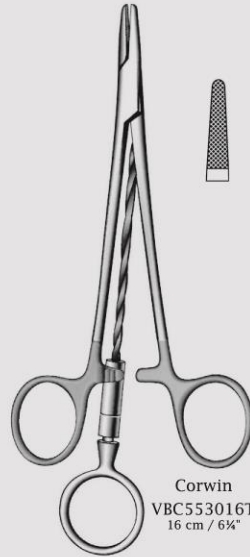
SQS Certificate
ISO 9001:2000
ISO 13485:2003

334

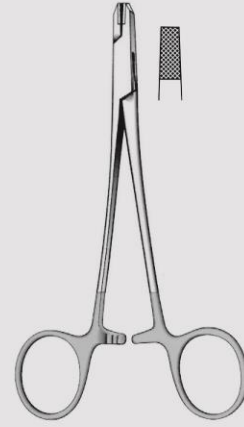
Instruments with Tungsten Carbide Inserts
Tc Gold



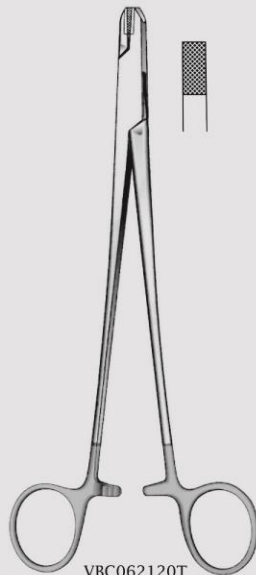
VBC552515T
15.5 cm / 6"



Corwin
VBC553016T
16 cm / 6 1/4"



VBC060115T
15 cm / 6"

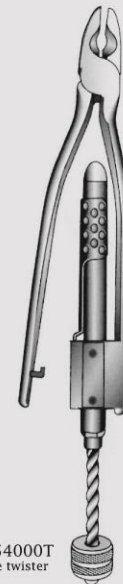


VBC062120T
20 cm / 8"

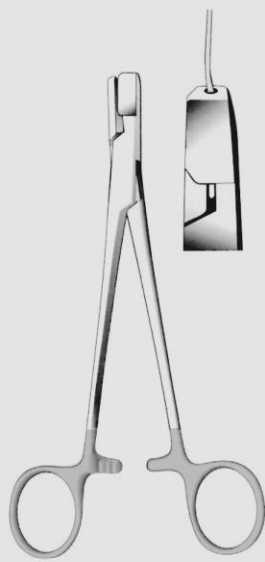


VBC553518T
18.5 cm / 7 1/4"

VBC553520T
20 cm / 8"



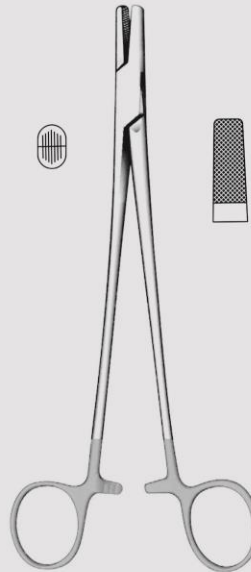
VBC554000T
Jet wire twister



VBC555017T
17 cm / 6 3/4"
Holding forceps for cerclage wire, with lateral jaws to avoid wire slipping off



VBC554515T
15 cm / 6"
Wire tightening pliers
ligature pliers



Baumgartner
VBC556020T
20 cm / 8"
Wire twister, ligature forceps



18 cm / 7"
Parallel grip



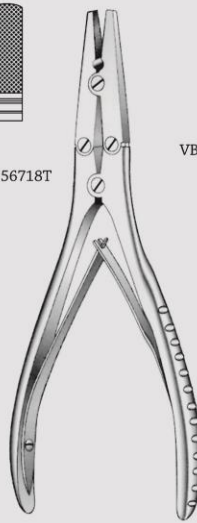
VBC556518T



VBC556618T



VBC556718T



18 cm / 7"
Parallel grip



VBC557018T



VBC557118T



Orthopedic
Wire Tightening Pliers, Flat Nose Pliers
Drahtspannerzangen, Flachzangen
Tensor tierra-hilo, Alicates de pico plano

ارتوپدی
سیم گیر



CE

SQS Certificate
ISO 9001:2000
ISO 13485:2003

335



Orthopedic
Wire Twister, Flat Nose Pliers, Wire Cutting Pliers
Flachzangen, Draht-Kneifzangen
Alicates planos, Alicates para cortar alambre

ارتوپدی
سیم گیر

ایزاد جراحی
دایموند

CE

SQS Certificate
ISO 9001:2000
ISO 13485:2003

336



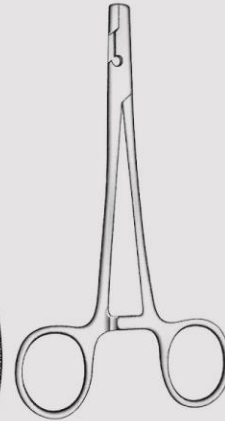
VBC557516
16 cm / 6 1/4"
Heavy pattern



VBC558015
15 cm / 6"
For bending & cutting



VBC558516
16.5 cm / 6 1/2"



VBC59000
Wire twister / Shear cutter
cuts wire up to 18g, twisted double



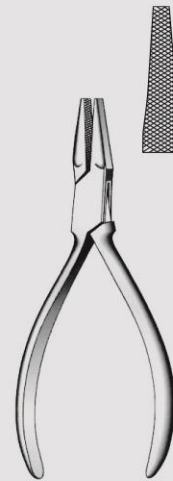
17 cm / 6 3/4"



VBC559617
With crosswise
groove



Hakstock
VBC560116
16 cm / 6 1/4"
With longitudinal groove



VBC560514
14 cm / 5 1/2"

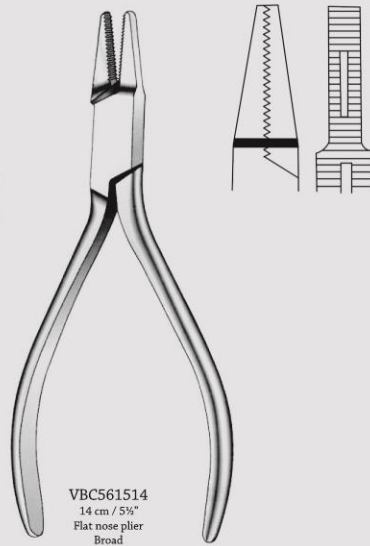


Orthopedic

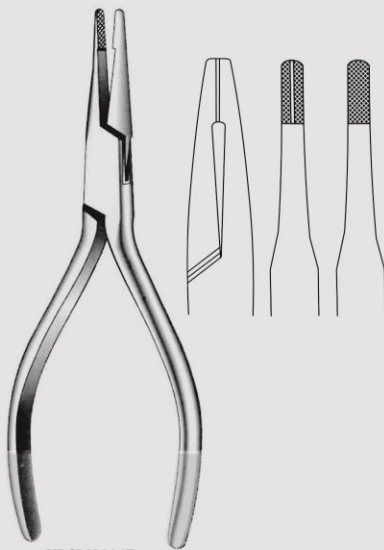
Flat Nose & Wire Twisting Pliers
Flachzangen, Draht-Kneifzangen
Alicates planos, Alicates para cortar alambre



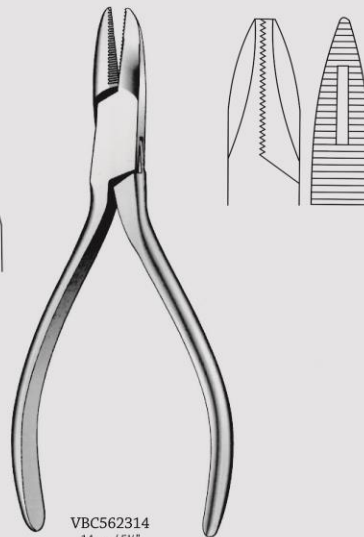
VBC561014
14 cm / 5 1/2"
Delicate



VBC561514
14 cm / 5 1/2"
Flat nose plier
Broad



VBC562014T
14 cm / 5 1/2"
4 mm tip
Pin pulling plier



VBC562314
14 cm / 5 1/2"
2 mm tip
Needle nose plier

ارتوپدی



CE

SQS Certificate
ISO 9001:2000
ISO 13485:2003

337



Orthopedic

Flat Nose Pliers, Wire Cutting & Twisting Pliers
Flachzangen, Draht-Knoetzangen und Drahtzangen
Alcates planos, Alcates para cortar alambre

ارتوپدی
دم باریک



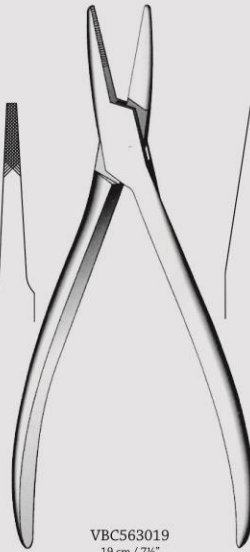
CE

SQS Certificate
ISO 9001:2000
ISO 13485:2003

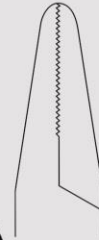
338



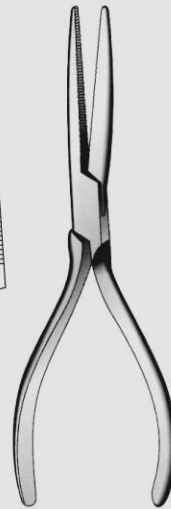
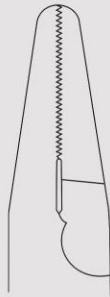
VBC562515
15 cm / 6"
Flat nose plier
2 mm tip for cerage wire
Delicate



VBC563019
19 cm / 7 1/4"
3 mm tip
Narrow nose
wire pulling forceps



VBC563516
16.5 cm / 6 1/2"
3 mm tip
Flat nose plier



VBC564018
18 cm / 7"
Jaw length: 2 1/2"
2 mm tip
Parallel grooved jaws
Long jaw needle nose plier





Orthopedic
Wire Tighteners and Drill
Chucks, Wire Twisters
Draht Spann und
spannfutter, Drahtzwirbel
Tensores cirra-hilo y mandril
de sujecion, Torcer de alambre



Jacobs
VBC350100 Small
VBC350200 Large
Stainless steel



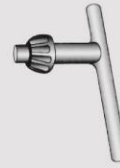
VBC350500
Key for jacobs chuck
Stainless steel



VBC565500
Wire tightener



VBC351000 Small
VBC351100 Large
Chuck chrome plated



VBC351200
Key for
chrome plated chuck



VBC567018
18 cm / 7"
Small cerclage wire twister
anodized aluminum handle



VBC567500
Large
anodized aluminum handle



VBC568000



VBC568500
Wire twister small
Stainless steel



VBC569018
18 cm / 7"
Large cerclage wire twister
anodized aluminum handle
Stainless steel tip

ارتوپدی
دریل



CE

SQS Certificate
ISO 9001:2000
ISO 13485:2003

339



Orthopedic
Drill Guide, Wire Twister & Wire Cutting Pliers
Flachzangen, Draht-Kneifzangen
Alicates planos, Alicates para cortar alambre

ارتوپدی
انبردست



CE

SQS Certificate
ISO 9001:2000
ISO 13485:2003

340



VBC569520
20 cm / 8"
Slip joint plier
10 mm tip
Maximum opening 2"



VBC570100
Drill guide

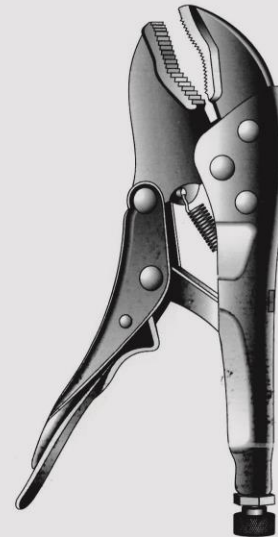
VBC570200 2.0 mm
VBC570300 2.7 mm
VBC570400 3.5 mm
VBC570500 4.5 mm



VBC571013 13 cm / 5 1/4"
VBC571017 17 cm / 6 3/4"



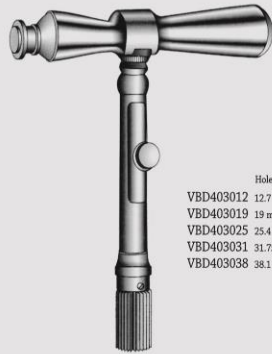
VBC571517 17 cm / 6 3/4"
VBC571512 12.5 cm / 5"
With side cutter



VBC572018
18 cm / 7"



Orthopedic
Trepine & Depth Gauge
Trepine
Trepano



Hudson
10 cm / 4"
Trepine

Hole size
VBD403012 12.7 mm / 1/2"
VBD403019 19 mm / 3/4"
VBD403025 25.4 mm / 1"
VBD403031 31.75 mm / 1 1/4"
VBD403038 38.1 mm / 1 1/2"



Michele
Trepine

		Inside Ø	Outside Ø
VBC573000	Small	3 mm	5 mm
VBC573100	Medium	4 mm	6 mm
VBC573200	Large	6 mm	8 mm

Facilitates removal of wire and broken bone screws.



VBC573500
Depth length 100 mm
Depth length 50 mm
Aluminum type



VBC574000
40 mm



VBC574500
60 mm



VBC575000
80 mm



VBC575500
110 mm

ارتوپدی
دبس گیج



SQS Certificate
ISO 9001:2000
ISO 13485:2003

341



Orthopedic
Wire Twisting Forceps
Draht-Zangen
Pinzas para torcer hilos

ارتوپدی
انبردست



CE

SQS Certificate
ISO 9001:2000
ISO 13485:2003

342

Heavy Duty Locking Pliers & Needle Nose Locking Pliers
with a new reinforced, more durable jaw.

- Heavy duty jaws lock securely onto pins.
- Reinforced jaw hinge and jousing are more rigid to
- Help prevent side to side shifting.
- Made from 300 and 400 series Surgical grade
- Stainless steel.
- Will not chip or contaminate other instrumentation
- Adjustment screw for easy control of jaw opening
- One handed, quick release self-locking lever.
- Available in three sizes.



VBC576017
17.5 cm / 6 7/8"
Tip width 7 mm
Maximum opening 1"
Small



VBC576020
20 cm / 8"
Tip width 9 mm
Maximum opening 1"
Medium



VBC576025
25.5 cm / 10"
Tip width 13 mm
Maximum opening 1"
Large



VBC576524
24 cm / 9 1/2"
Length of jaw 2 1/2"
Tip width 5 mm
Jaws are parallel at 3 mm



VBC576530
30 cm / 12"
Length of jaw 3"
Tip width 7 mm
Jaws are parallel at 5 mm
Large



Locking plier



Needle nose locking plier



Orthopedic
Wire Cutting Pliers
Draht-Kneifzangen
Alicates para cortar alambre

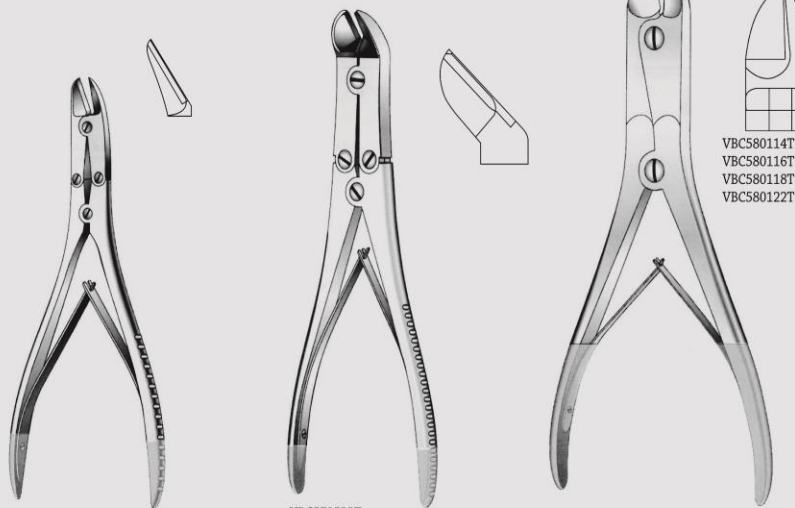


VBC577016
16 cm / 6 1/4"

"Diamant"
VBC577516
16 cm / 6 1/4"
for soft wires up to 2.5 mm \emptyset
for hard wires up to 2.0 mm \emptyset

VBC578000
16 cm / 6 1/4"
for soft wires up to 2.4 mm \emptyset
for hard wires up to 1.8 mm \emptyset

VBC578516T 16 cm / 6 1/4"
VBC578518T 18 cm / 7"
VBC578520T 20 cm / 8"



VBC579014T 14 cm / 5 1/2"
VBC579016T 16 cm / 6 1/4"
VBC579018T 18 cm / 7"

VBC579522T
22 cm / 8 3/4"
For soft wires up to 2.6 mm \emptyset
For hard wires up to 2.2 mm \emptyset

For soft wires up to 3 mm \emptyset
For hard wires up to 2.2 mm \emptyset

VBC580114T 14 cm / 5 1/2"
VBC580116T 16 cm / 6 1/4"
VBC580118T 18 cm / 7"
VBC580122T 22 cm / 8 3/4"

ارتوپدی
پین بر



SQS Certificate
ISO 9001:2000
ISO 13485:2003

343



Orthopedic
Wire Cutting Pliers
Draht-Kneifzangen
Alicates para cortar alambre

ارتوپدی
پین بر



SQS Certificate
ISO 9001:2000
ISO 13485:2003

344



VBC580515
15 cm / 6"
For soft wires up to 2.0 mm Ø
For hard wires up to 1.2 mm Ø

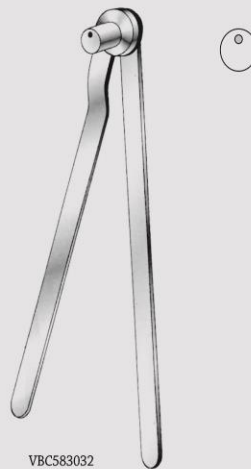
VBC581024
24 cm / 9 1/2"

VBC581518T
18 cm / 7"
For soft wires up to 2 mm Ø
For hard wires up to 1.5 mm Ø

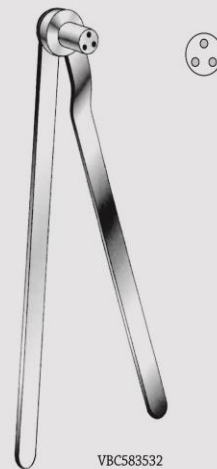
VBC582017T
17 cm / 6 1/2"
Angled slender pattern for wire
removal (for soft wire up to diameter
0.9 mm) after sternum suture



VBC582522T
22 cm / 8 3/4"
For soft wire up to 3.5 mm Ø
For hard wire up to 2.5 mm Ø



VBC583032
32 cm / 12 1/2"
For soft wire up to 3.0 mm Ø
For hard wire up to 3.0 mm Ø



VBC583532
32 cm / 12 1/2"
Cut three wires at once
For soft wire up to 4.0 mm Ø
For hard wire up to 3.0 mm Ø



Orthopedic
Wire Cutting Pliers
Draht-Kneifzangen
Alicates para cortar alambre



VBC584025
25 cm / 10"
For wires up to 3.0 mm
Head cutter

VBC584538
38 cm / 15"
For wires up to 4.0 mm
Head cutter

VBC585038T 38.5 cm / 15" For wire 5 mm
VBC585045T 45 cm / 17 3/4" 6 mm
VBC585056T 56 cm / 22" 7.5 mm
TC wire cutter

ارتوپدی
پین بر



SQS Certificate
ISO 9001:2000
ISO 13485:2003

345



Orthopedic
Wire Cutting Pliers
Draht-Kneifzangen
Alicates para cortar alambre

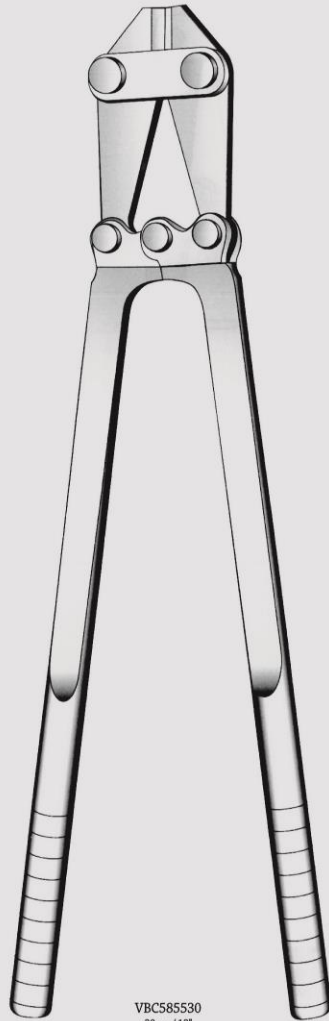
ارتوپدی
پین بر



CE

SQS Certificate
ISO 9001:2000
ISO 13485:2003

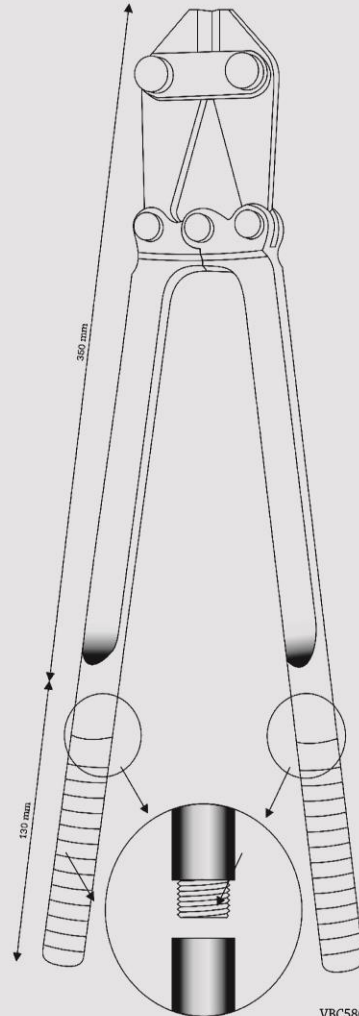
346



VBC585530
30 cm / 12"

VBC585547
47 cm / 18 1/2"

Cutter for cutting off kirschner wires,
tibia head screws
bolts, pins up to 6 mm Ø

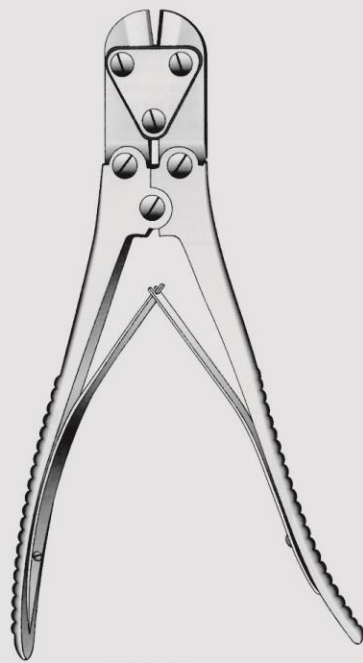
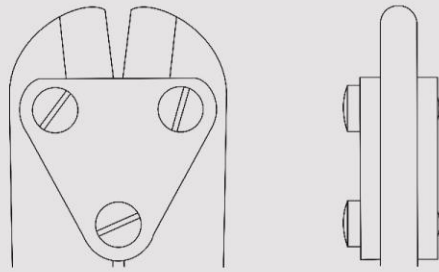


VBC586048
48 cm / 19"

Cutter for cutting off wires,
head screws
and pins up to 6 mm



Orthopedic
Wire Cutting Pliers
Draht-Kneifzangen
Alicates para cortar alambre



VBC586524
24 cm / 9 1/2"
Plate cutting forceps
For cutting stainless steel
mini plates up to 1 mm



VBC587038
38 cm / 15"
Surgeon double action pin cutter
Heavy duty with Carb-N-Sert cutting blades
cut upto 3/16" Ø
Stainless steel

ارتوپدی
پین بر



CE

SQS Certificate
ISO 9001:2000
ISO 13485:2003

347



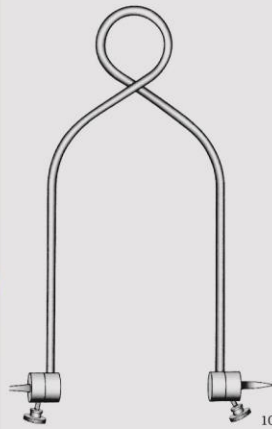
**Orthopedic
Extension Bows**
Extensionbugel
Extribos para extension

ارتوپدی

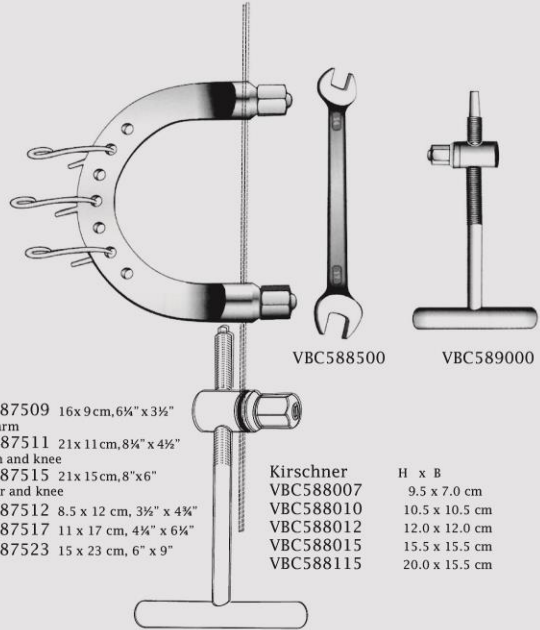


SQS Certificate
ISO 9001:2000
ISO 13485:2003

348



- VBC587509 16x9cm, 6¼" x 3½"
For arm
- VBC587511 21x11cm, 8¼" x 4½"
For thigh and knee
- VBC587515 21x15cm, 8" x 6"
For femur and knee
- 10 VBC587512 8.5 x 12 cm, 3½" x 4¾"
- 10 VBC587517 11 x 17 cm, 4¾" x 6¾"
- 10 VBC587523 15 x 23 cm, 6" x 9"

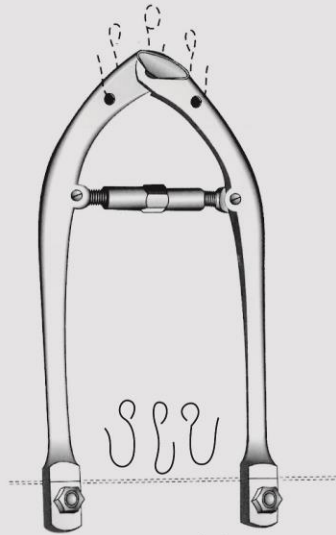


VBC588500

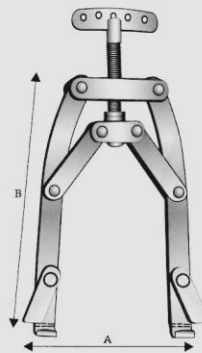
VBC589000

Kirschner
VBC588007
VBC588010
VBC588012
VBC588015
VBC588115

H x B
9.5 x 7.0 cm
10.5 x 10.5 cm
12.0 x 12.0 cm
15.5 x 15.5 cm
20.0 x 15.5 cm



h x b
VBC589510 18x10cm
VBC589516 27x16cm



Kirschner U.S.
VBC590120 Small 100 13 x 20 cm
VBC590227 Medium 150 20 x 27 cm
VBC590300 Large
VBC590400 X-Large



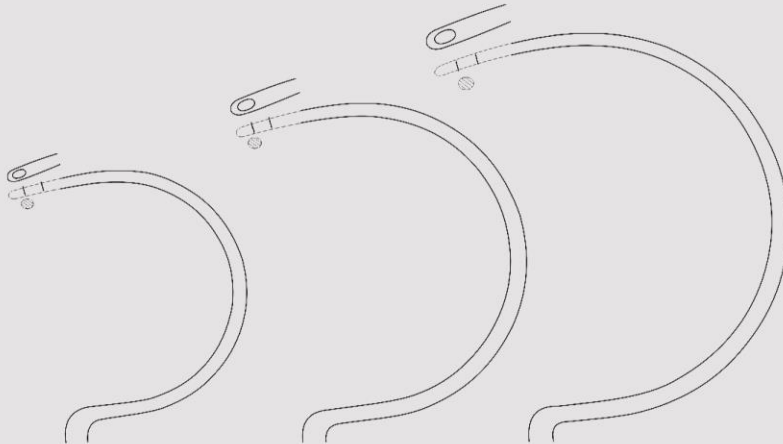
VBC590500
Traction hooklet
for extension bows



VBC590600
Traction hooklet
for extension bows



Orthopedic
 Bone Wire Guides & Graft Passer
 Drahtumführungsnaedeln
 A ugujas Pass-hiles



VBC591027
 27.5 cm / 10¾"
 Fig. 3

VBC591028
 28.5 cm / 11¼"
 Fig. 2

VBC591030
 30.5 cm / 12"
 Fig. 1



Demel
 Wire guides

ارتوپدی
 وایر پسر



VBC591524
 24 cm / 9½"

VBC591527
 27 cm / 10¾"

VBC592022
 22.5 cm / 9"

Graft Passer
 VBC592500
 XL-Large
 Curved
 Slot cut into head

VBC592600
 X-Small

VBC592800
 Large

VBC592700
 Small

VBC592900
 X-Large



CE

SQS Certificate
 ISO 9001:2000
 ISO 13485:2003

349



Orthopedic
Bone Wire Tighteners,
Wire Passers & Bone Nailing
Drahtspanninstrumente
Tensores cierra-hilo

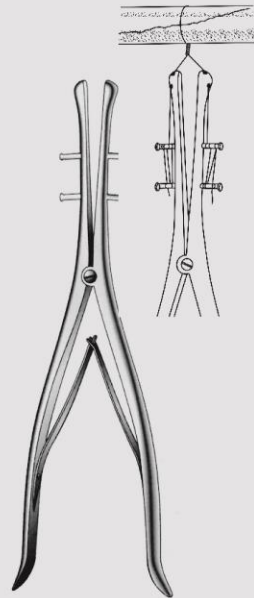
ارتوپدی
وایرپسر



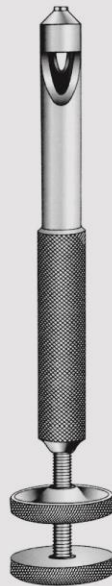
CE

SQS Certificate
ISO 9001:2000
ISO 13485:2003

350



Demel
VBC593028
28 cm / 11"



Loute
VBC593521
21 cm / 8 3/4"



VBC594000
Cerclage wire passer



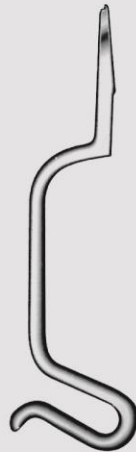
VBC594500
45 mm



VBC595000
70 mm



Kuentcher
26 cm / 10 3/4"
VBC595526 8 mm
VBC595626 10 mm
VBC595726 12.5 mm



Kuentcher
VBC596035
35 cm / 14"



VBC596500
VBC596600



VBC597029 29cm/11 1/2"
VBC597037 37cm/14 3/4"
VBC597042 42cm/16 3/4"
VBC597049 49cm/19 3/4"

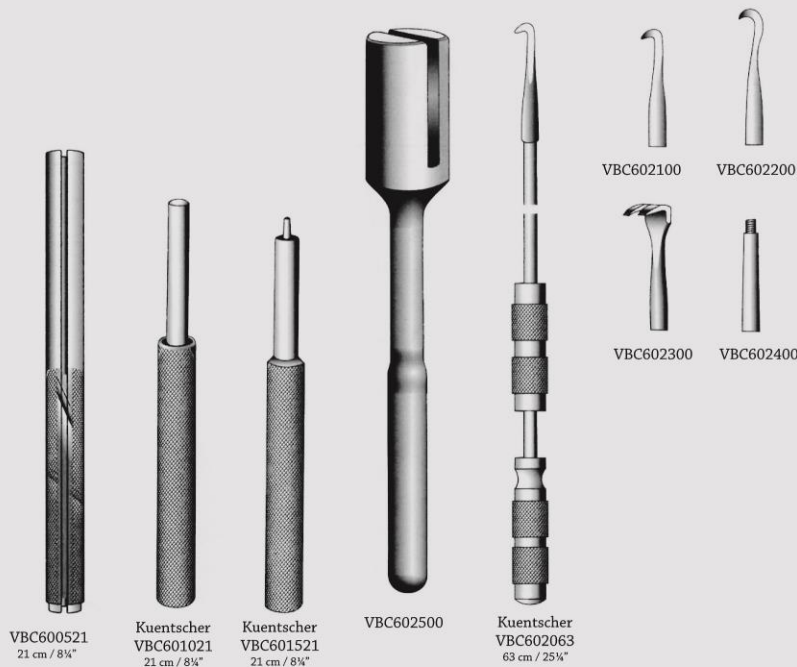


VBC597500 2.4mm
VBC597600 3.2mm
VBC597700 4.8mm
VBC597800 6.4mm



Orthopedic
Bone Nailing Instruments

ارتوپدی



CE

SQS Certificate
ISO 9001:2000
ISO 13485:2003

351



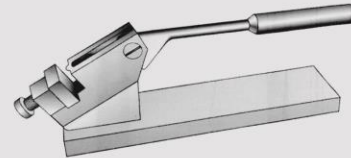
Orthopedic
Bone Plate Benders

ارتوپدی
پلاک خم کن

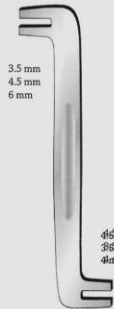


SQS Certificate
ISO 9001:2000
ISO 13485:2003

352

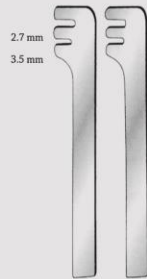


VBC604500
Large bone plate press
VBC604600
Small bone plate press



3.5 mm
4.5 mm
6 mm

45mm
35mm
4mm



2.7 mm

3.5 mm

3.5 mm
2.7 mm



1.5 mm
1.8 mm
2 mm

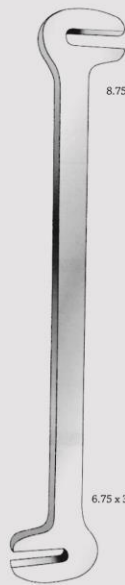
VBC603020 3.5 mm, 4.5 mm
VBC603120 4.5 mm, 3.5 mm
20 cm / 8"
VBC603225 6 mm, 4 mm
25 cm / 8"

VBC603514
14 cm / 5 1/2"
Plate benders
Pair

VBC604013 1.5 mm
VBC604113 2 mm
13 cm / 5 1/4"
VBC604212 1.8 mm
12 cm / 4 3/4"



VBC605022
22 cm / 8 3/4"



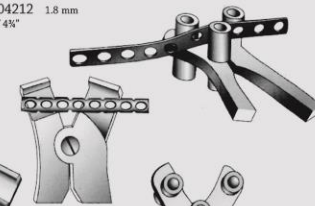
8.75 x 30 mm

6.75 x 30 mm

VBC605523 23 cm / 9"
VBC605518 18 cm / 7"
Thickness 14 mm
Wide 9 mm
Bone plate bender



VBC606000
Plate bending plier



VBC606500
Plate bending plier

DIAMOND SURGICAL
WWW.DIAMONDMED.IR INSTRUMENTS



VBD
Rib Shears
Cardiovascular



CE

SQS Certificate
ISO 9001:2000
ISO 13485:2003





Rib Shears
Bone and Rib Shears
Knochen-und rippenscheren
Cizallas para huesos y costillas

ن

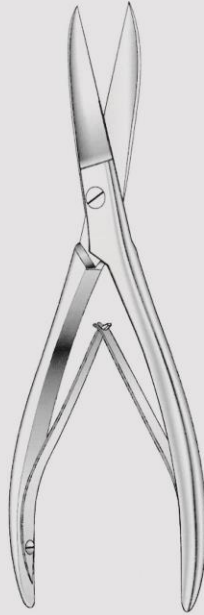
قلبی عروقی
دنده بر



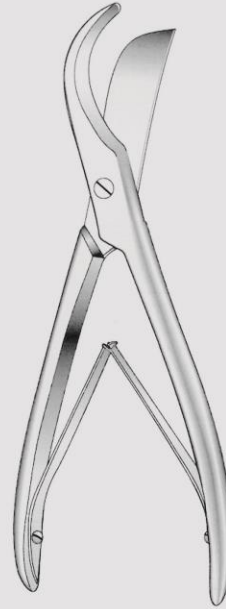
CE

SQS Certificate
ISO 9001:2000
ISO 13485:2003

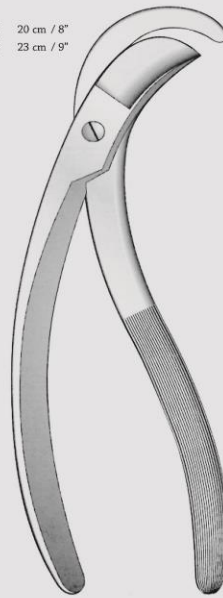
354



VBD300120 20 cm / 8"
VBD300123 23 cm / 9"



VBD300522
22 cm / 8 3/4"



VBD301019
19 cm / 7 1/2"



Gluck
VBD301519 19 cm / 7 1/2"
VBD301522 22 cm / 8 3/4"
Drawing cut



Rib Shears
Bone and Rib Shears
Knochen- und rippenscheren
Cizallas para huesos y costillas

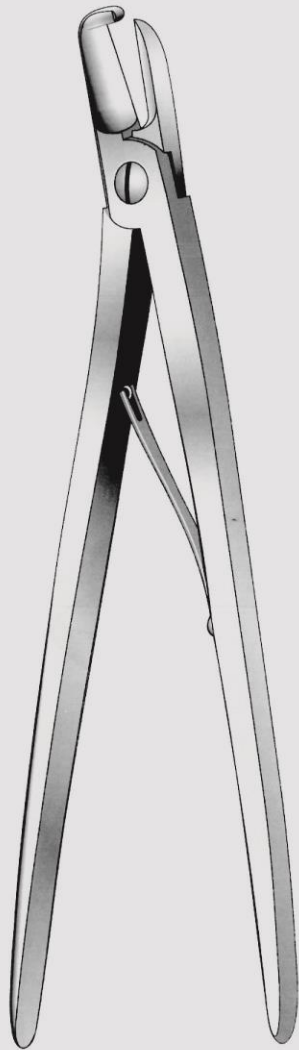
قلب و عروق
دنده بر



CE

SQS Certificate
ISO 9001:2000
ISO 13485:2003

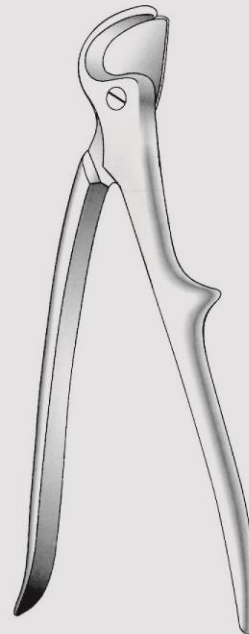
355



Coryllos Bethune (Collin)
VBD302024 24cm/9½" VBD302124
VBD302030 30cm/12" VBD302130
For right hand For left hand



Roos
VBD302533
33 cm / 13¼"



Stille
VBD303021
21 cm / 8¼"



Rib Shears
Bone and Rib Shears
Knochen-und rippenscheren
Cizallas para huesos y costillas

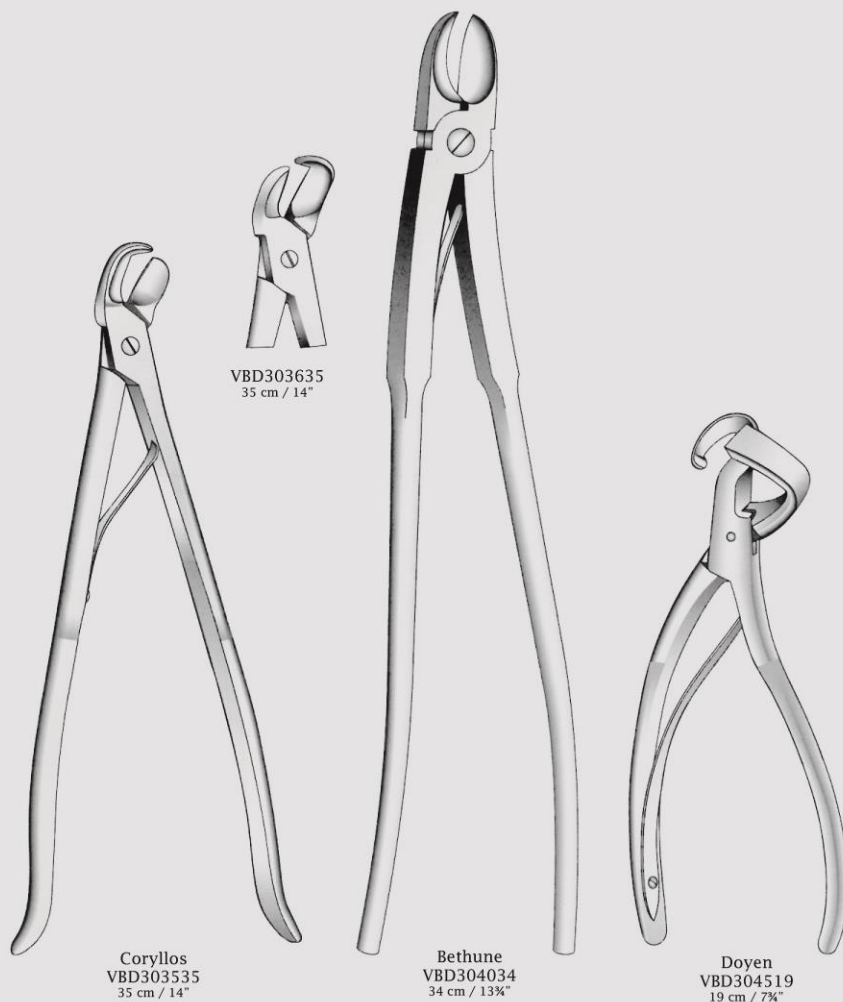
قلبي و عروقي
دنده بر



CE

SQS Certificate
ISO 9001:2000
ISO 13485:2003

356





Rib Shears
Rib Shears
Rippenscheren
Costotomos

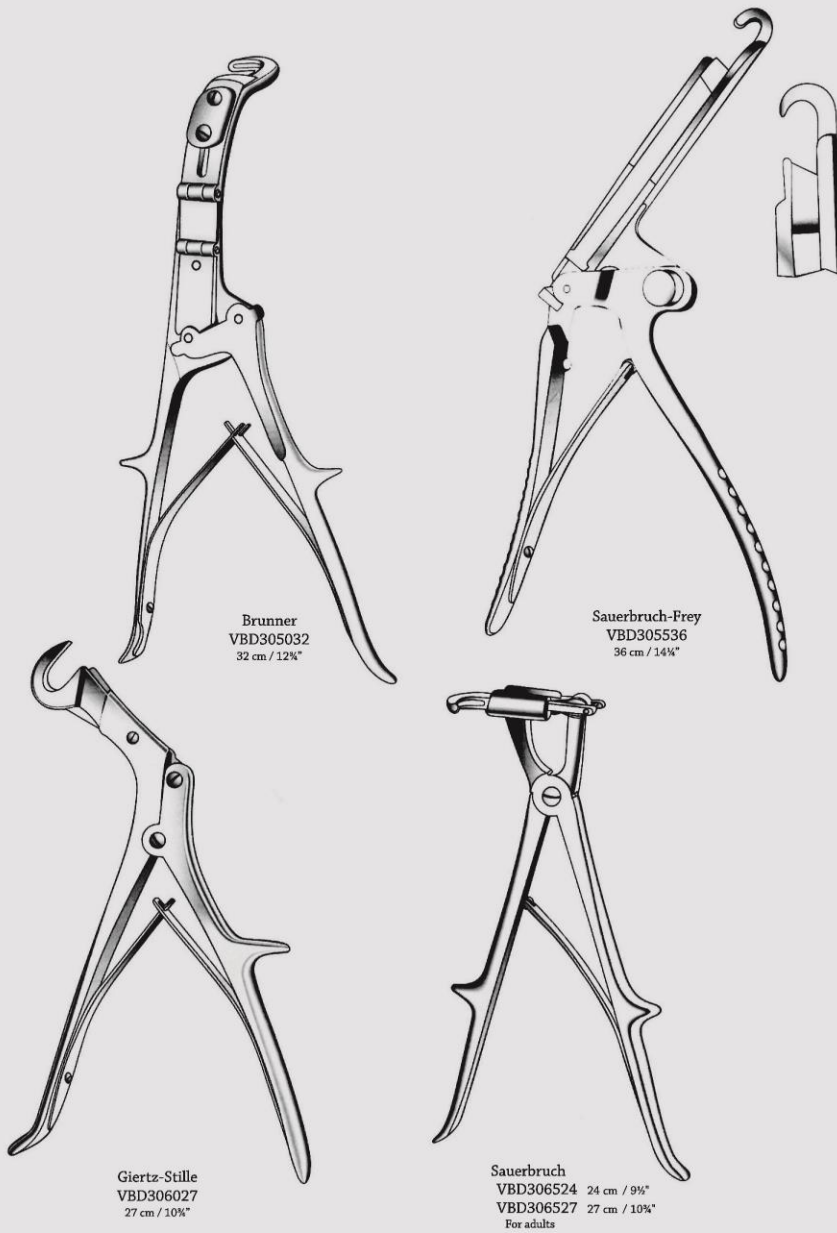
قلبی عروقی
دنده بر



CE

SQS Certificate
ISO 9001:2000
ISO 13485:2003

357



Brunner
VBD305032
32 cm / 12 1/2"

Sauerbruch-Frey
VBD305536
36 cm / 14 1/2"

Giertz-Stille
VBD306027
27 cm / 10 1/2"

Sauerbruch
VBD306524 24 cm / 9 1/2"
VBD306527 27 cm / 10 1/2"
For adults



Rib Spreaders
Rib Spreaders
Rippensperrer
Separadores costales

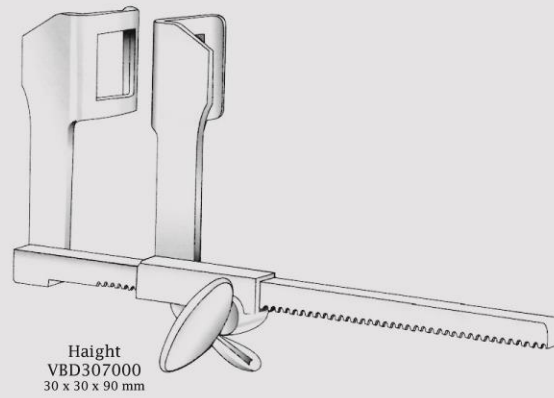
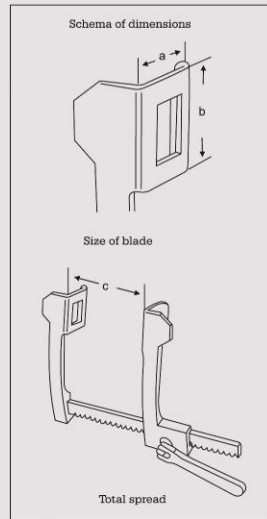
قلبي و عروقي
توراكس



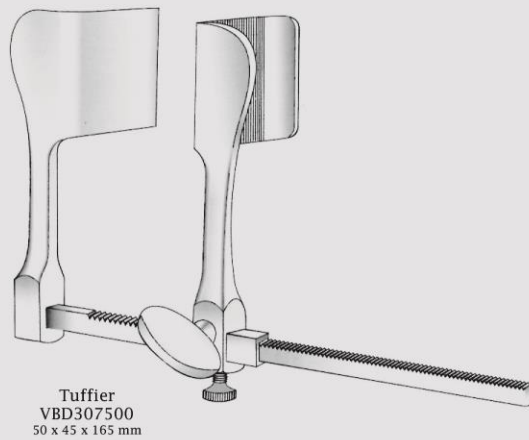
CE

SQS Certificate
ISO 9001:2000
ISO 13485:2003

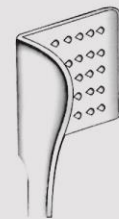
358



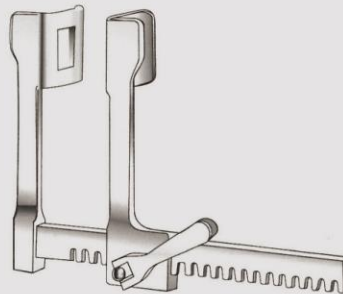
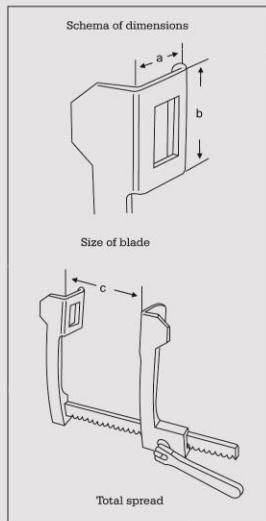
Haight
VBD307000
30 x 30 x 90 mm



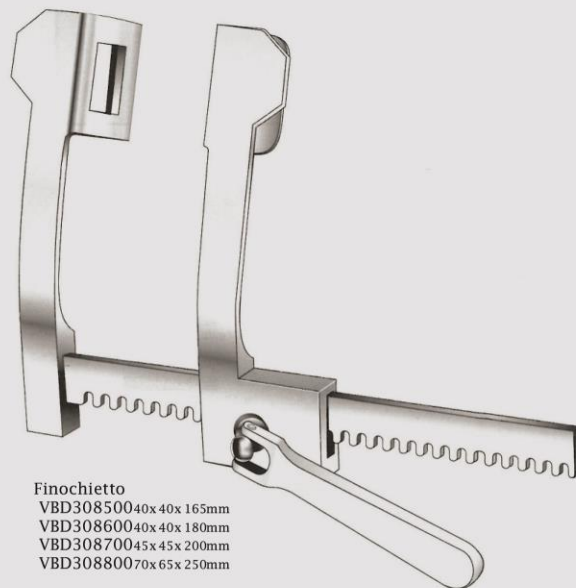
Tuffier
VBD307500
50 x 45 x 165 mm



VBD307600



Finochietto-Baby
VBD308000
18 x 20 x 75 mm



Finochietto
VBD308500 40x 40x 165mm
VBD308600 40x 40x 180mm
VBD308700 45x 45x 200mm
VBD308800 70x 65x 250mm

Rib Spreaders
Rib Spreaders
Rippensperrer
Separadores costales

قلبی و عروقی
توراکس



CE

SQS Certificate
ISO 9001:2000
ISO 13485:2003

359



Rib Spreaders
Rib Retractors
Rippensperrer
Separadores costales

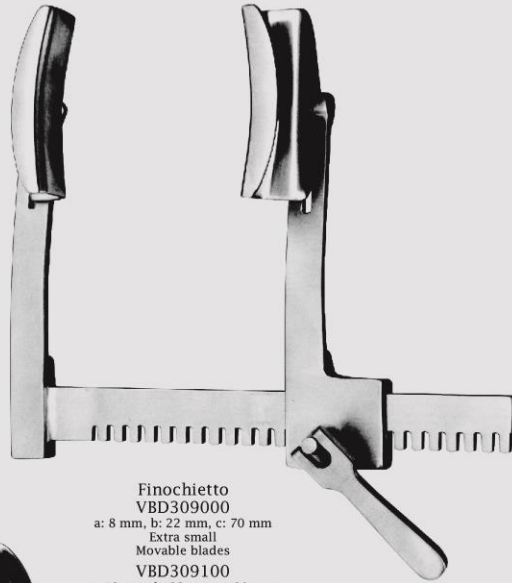
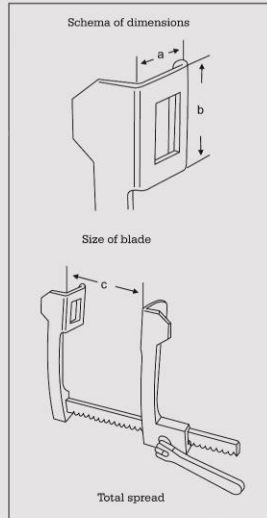
قلبي و عروقي
توراكس



CE

SQS Certificate
ISO 9001:2000
ISO 13485:2003

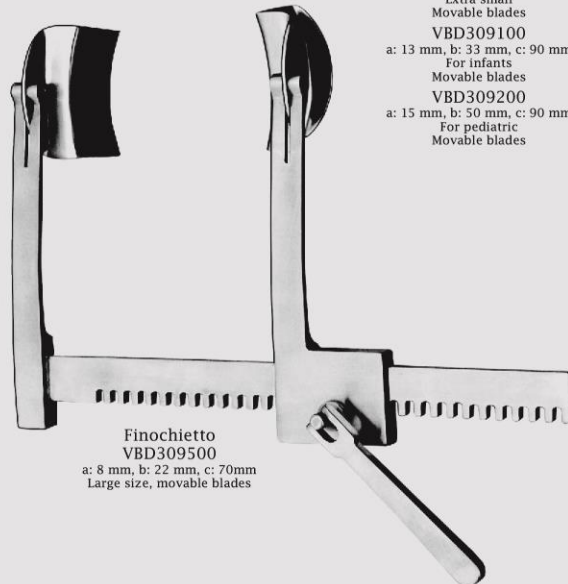
360



Finochietto
VBD309000
a: 8 mm, b: 22 mm, c: 70 mm
Extra small
Movable blades

VBD309100
a: 13 mm, b: 33 mm, c: 90 mm
For infants
Movable blades

VBD309200
a: 15 mm, b: 50 mm, c: 90 mm
For pediatric
Movable blades

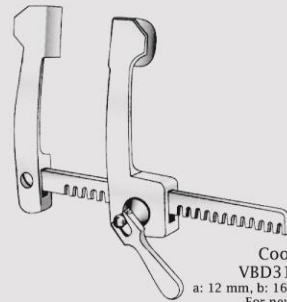
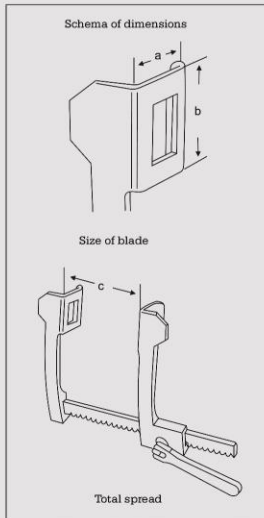


Finochietto
VBD309500
a: 8 mm, b: 22 mm, c: 70mm
Large size, movable blades

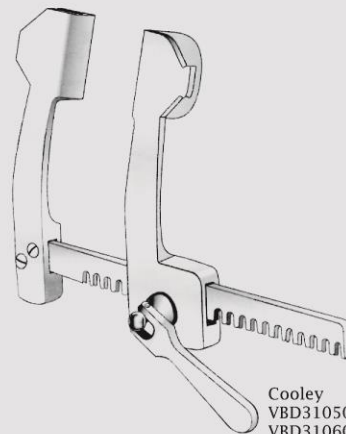
www.Diamondmed.ir



Rib Spreaders
 Rib Spreaders
 Rippensperrer
 Separadores costales

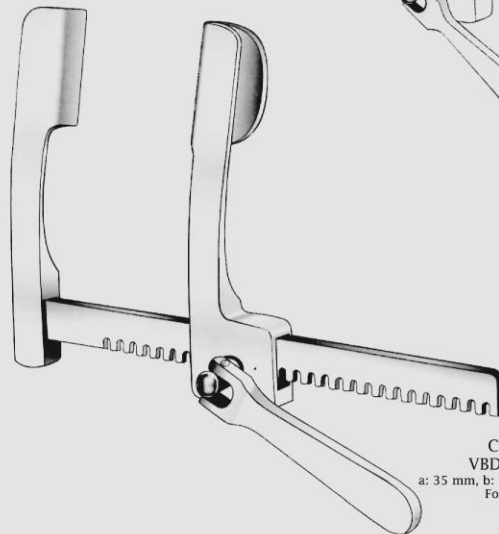


Cooley
 VBD310100
 a: 12 mm, b: 16 mm, c: 95 mm
 For new born



Cooley	a	b	c
VBD310500	15mm	30mm	140mm
VBD310600	21mm	44mm	150mm

Pediatric size



Cooley
 VBD311000
 a: 35 mm, b: 50 mm, c: 200 mm
 For adults

قلبی و عروقی
 توراکس



CE

SQS Certificate
 ISO 9001:2000
 ISO 13485:2003





Rib Spreaders
Rib Spreaders
Rippensperrer
Separadores costales

قلبی عروقی
توراکس



CE

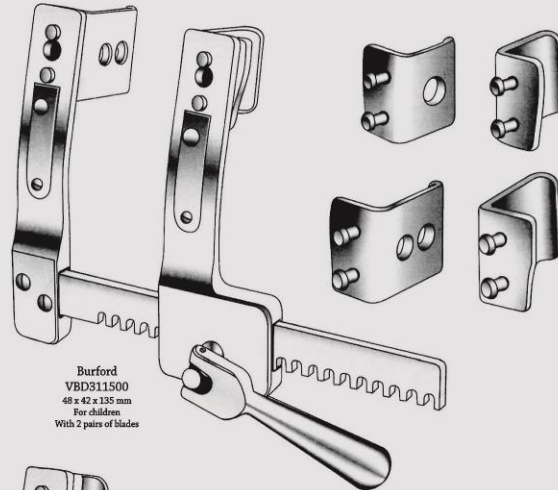
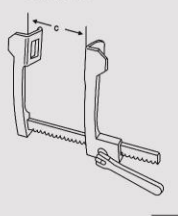
SQS Certificate
ISO 9001:2000
ISO 13485:2003

362

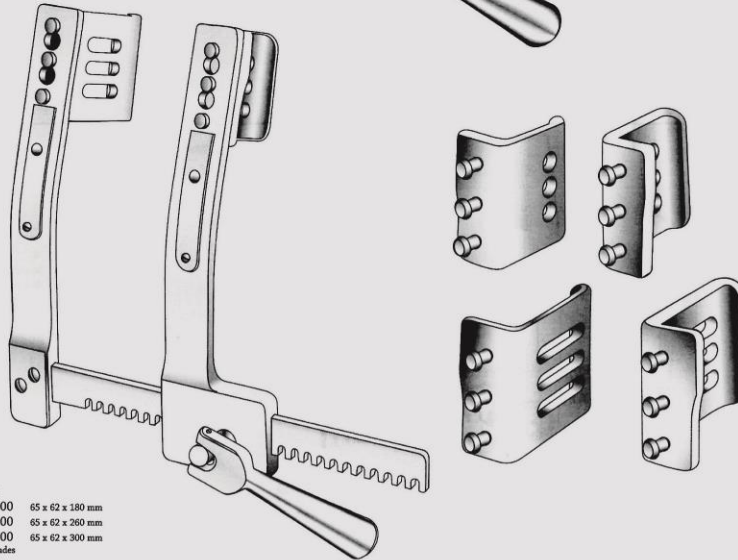
size of blade



Total spread



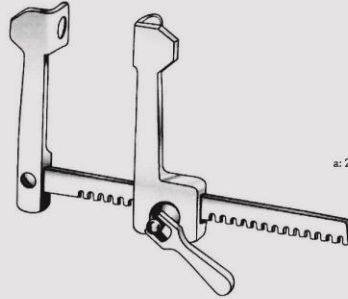
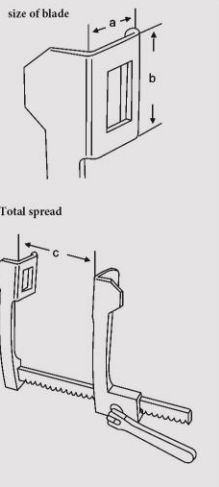
Burford
VBD311500
48 x 42 x 135 mm
For children
With 2 pairs of blades



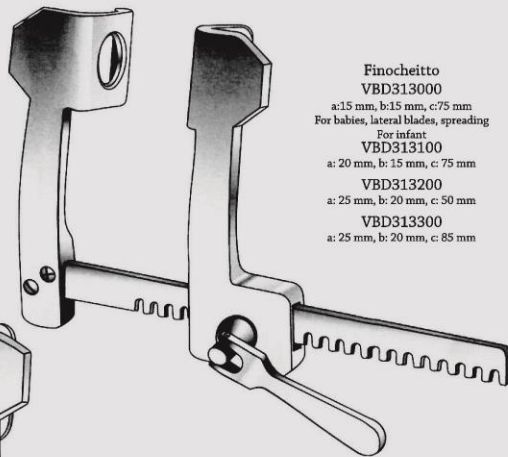
Burford
VBD312000 65 x 62 x 180 mm
VBD312100 65 x 62 x 260 mm
VBD312200 65 x 62 x 300 mm
With 2 pairs of blades
For adults



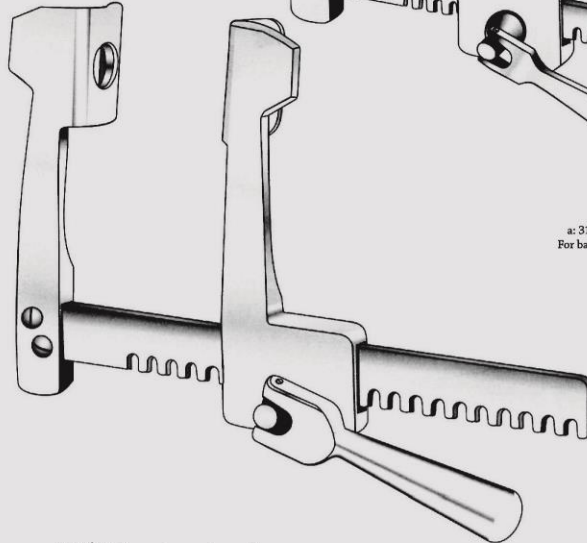
Rib Spreaders
Rib Retractors
Rippensperrer
Separadores costales



Tiny Finochietto
VBD312500
a: 20 mm, b: 20 mm, c: 65 mm



Finochetto
VBD313000
a:15 mm, b:15 mm, c:75 mm
For babies, lateral blades, spreading
For infant
VBD313100
a: 20 mm, b: 15 mm, c: 75 mm
VBD313200
a: 25 mm, b: 20 mm, c: 50 mm
VBD313300
a: 25 mm, b: 20 mm, c: 85 mm



Finochetto
VBD313500
a: 31 mm, b: 31 mm, c: 100 mm
For babies, lateral blades, spreading
For infant

Finochietto	a	b	c
VBD314000	40 mm	45 mm	135 mm
VBD314100	52 mm	62 mm	175 mm
VBD314200	85 mm	65 mm	175 mm

Lateral blades, spreading

قلبی عروقی
توراکس



SQS Certificate
ISO 9001:2000
ISO 13485:2003

363



Rib Spreaders
Rib Spreaders
Rippensperrer
Separadores costales

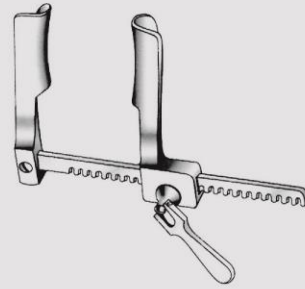
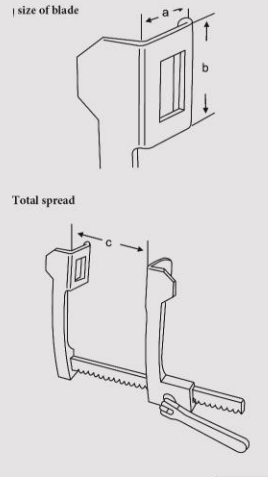
قلبی عروقی
توراکس



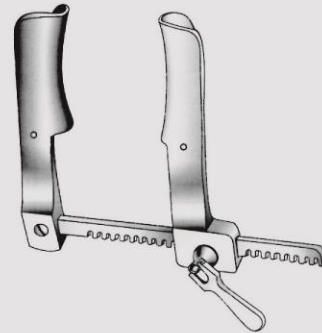
CE

SQS Certificate
ISO 9001:2000
ISO 13485:2003

364



Castaneda
VBD314500
a: 10.5 mm, b: 32 mm, c: 65 mm
For babies, lateral blades, spreading



Castaneda
VBD315000
a: 12 mm, b: 45 mm, c: 70 mm
For infants, lateral blades, spreading

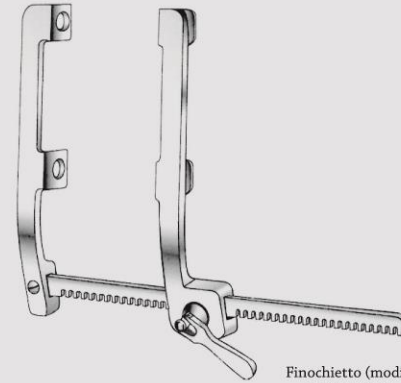
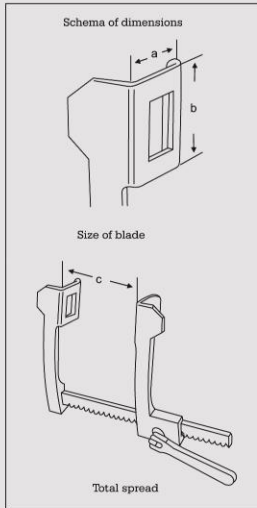


Castaneda
VBD315500
a: 15 mm, b: 60 mm, c: 120 mm
For infants, lateral blades, spreading

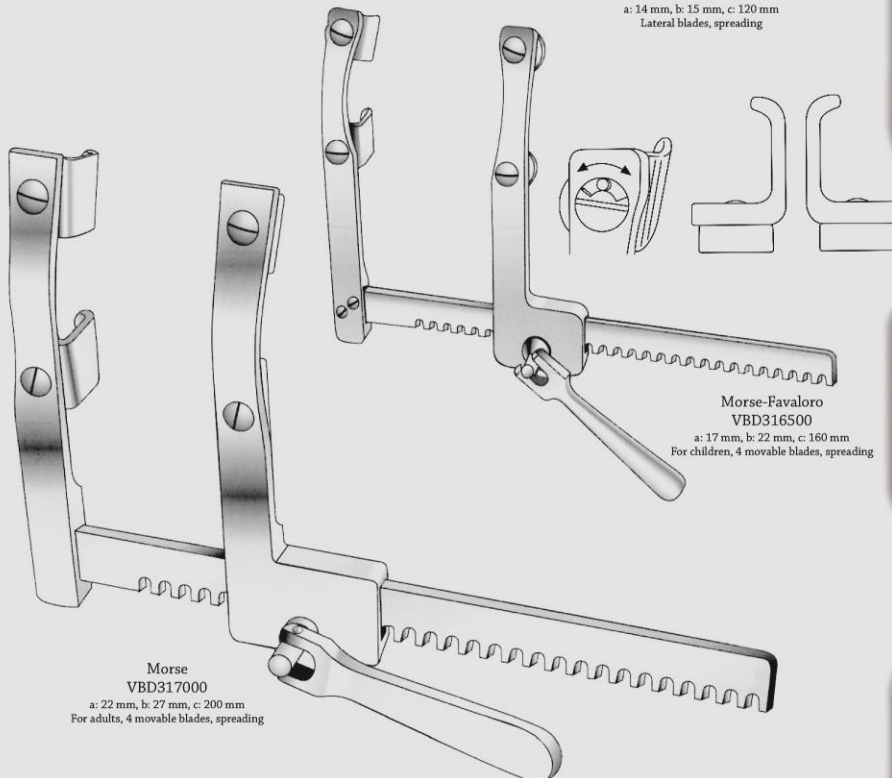


Rib Spreaders

Rib and Sternal Retractors
Rippensperrer und Sternumspreizer
Separadores costales Y esternales



Finochietto (modif)
VBD316000
a: 14 mm, b: 15 mm, c: 120 mm
Lateral blades, spreading



قلبی و عروقی
توراکس



CE

SQS Certificate
ISO 9001:2000
ISO 13485:2003

365



Rib Spreaders
Rib Retractors
Rippensperrer
Separadores costales

قلبی عروقی
توراکس

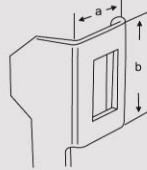


CE

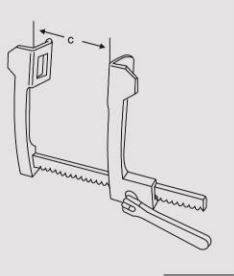
SQS Certificate
ISO 9001:2000
ISO 13485:2003

366

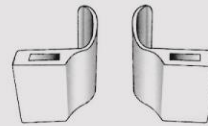
size of blade



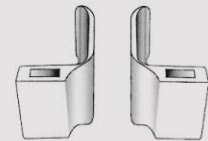
Total spread



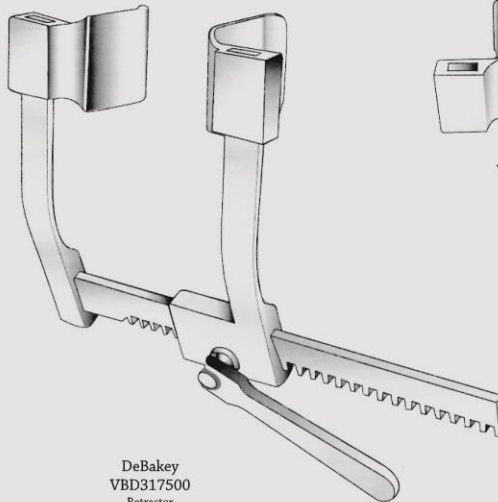
VBD317600
30 x 30 mm
Lateral blades
Fig. 1



VBD317700
40 x 40 mm
Lateral blades
Fig. 2



VBD317800
50 x 50 mm
Lateral blades
Fig. 3

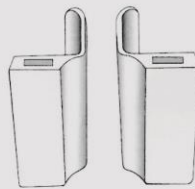
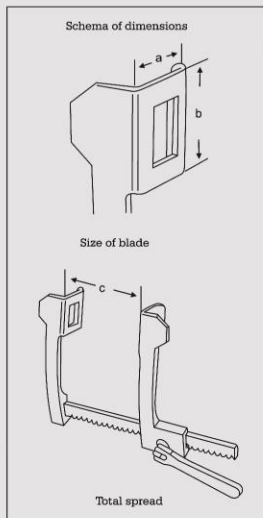


DeBaKey
VBD317500
Retractor

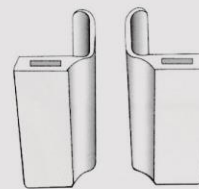
De BaKey
VBD317900
Set of one retractor & three blades
Spreading 150 mm



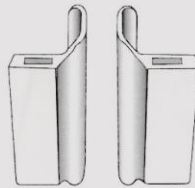
Rib Spreaders
Rib Retractors
Rippensperrer
Separadores costales



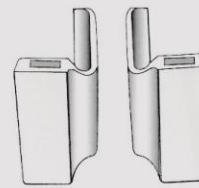
VBD318100
60 x 60 mm
Lateral blades
Fig. 1



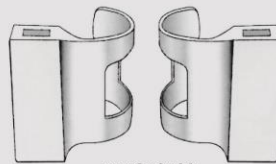
VBD318200
50 x 80 mm
Lateral blades
Fig. 2



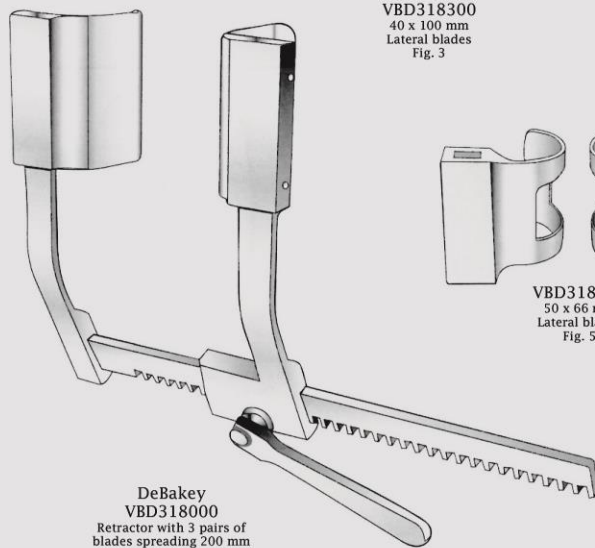
VBD318300
40 x 100 mm
Lateral blades
Fig. 3



VBD318400
80 x 60 mm
Lateral blades
Fig. 4



VBD318500
50 x 66 mm
Lateral blades
Fig. 5



DeBaKey
VBD318000
Retractor with 3 pairs of
blades spreading 200 mm

قلبی و عروقی
توراکس



CE

SQS Certificate
ISO 9001:2000
ISO 13485:2003

367



Cardiovascular Surgery
Thoracic Retractor
Thoraxsperrer
Separador toracico

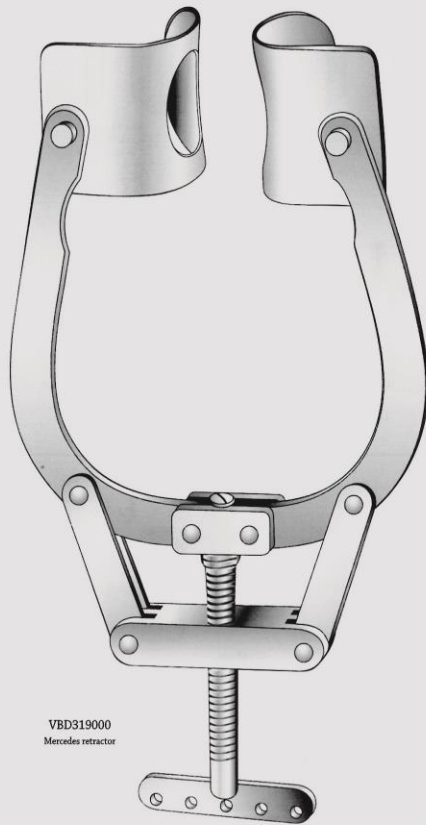
قلبي عروقي
توراكس



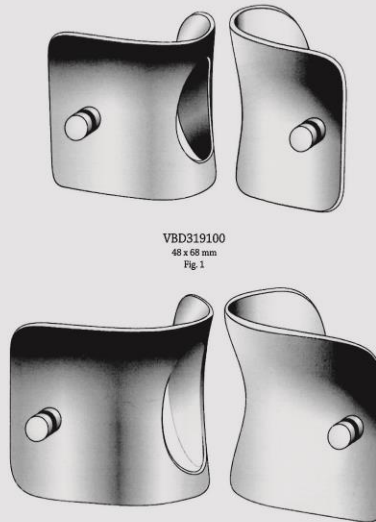
CE

SQS Certificate
ISO 9001:2000
ISO 13485:2003

368



VBD319000
Mercedes retractor



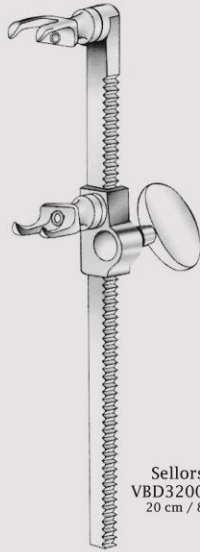
VBD319100
48 x 68 mm
Fig. 1

VBD319200
70 x 75 mm
Fig. 2

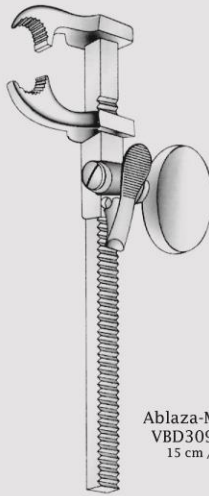
VBD319300
Complete set
one retractor &
one pair of blades each



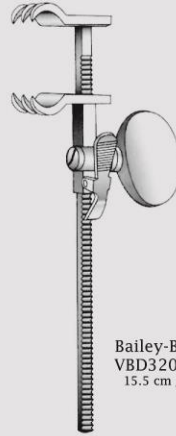
Cardiovascular Surgery
Rib Contractors
Rippenkontraktoren
Aproximadores para costillas



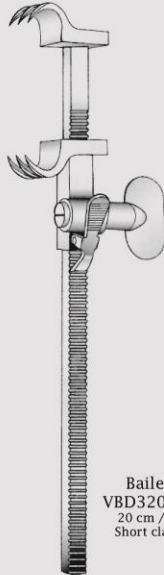
Sellors
VBD320020
20 cm / 8"



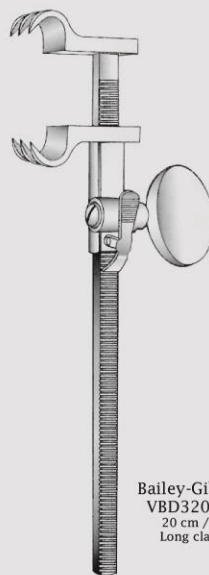
Ablaza-Morse
VBD309515
15 cm / 6"



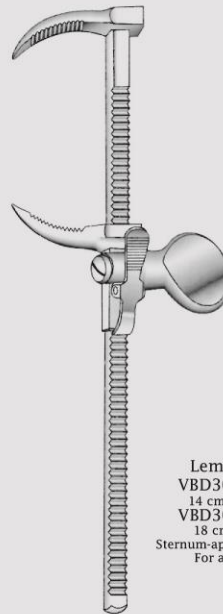
Bailey-Baby
VBD320315
15.5 cm / 6"



Bailey
VBD320520
20 cm / 8"
Short claws



Bailey-Gibbon
VBD320820
20 cm / 8"
Long claws



Lemmon
VBD309814
14 cm / 5 1/2"
VBD309818
18 cm / 7"
Sternum-approximator
For adults

قلبی و عروقی
دنده نزدیک کن



CE

SQS Certificate
ISO 9001:2000
ISO 13485:2003

369

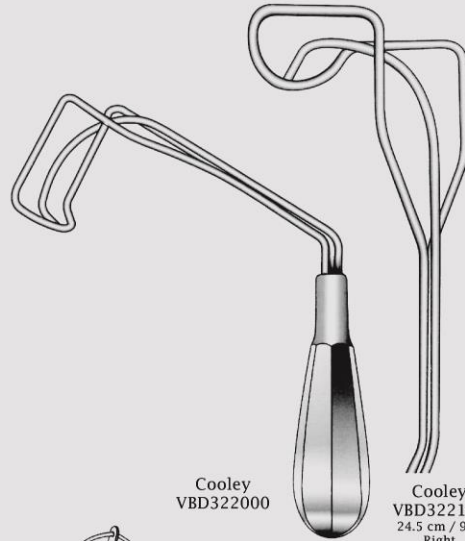


Cardiovascular Surgery
 Rib Contractors & Spatulas
 Rippenkontraktoren und Spatel
 Aproximadores para costillas Y Espatula

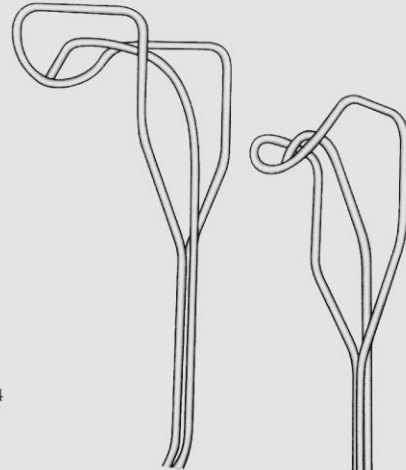
قلبي و عروقي
 اكار تورها



SQS Certificate
 ISO 9001:2000
 ISO 13485:2003



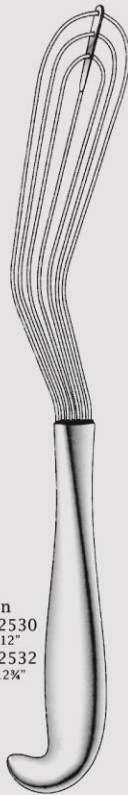
Cooley
 VBD322000



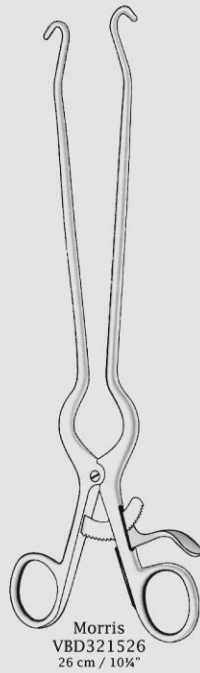
Cooley
 VBD322124
 24.5 cm / 9 3/4"
 Right

Cooley
 VBD322224
 24.5 cm / 9 3/4"
 Right, slightly serrated

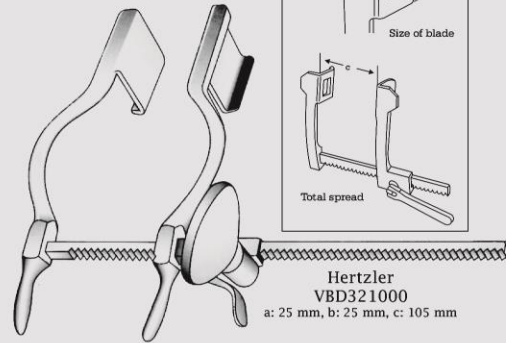
Cooley
 VBD322325
 25.5 cm / 10"
 Left



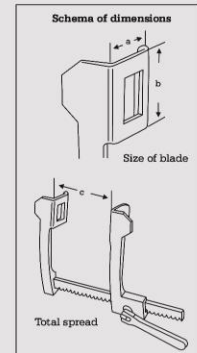
Allison
 VBD322530
 30 cm / 12"
 VBD322532
 32 cm / 12 3/4"



Morris
 VBD321526
 26 cm / 10 1/4"

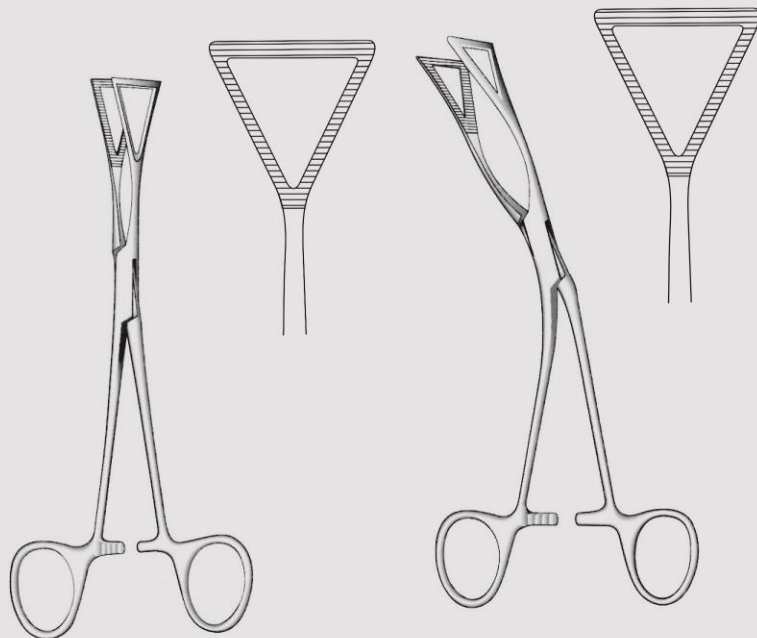


Hertzer
 VBD321000
 a: 25 mm, b: 25 mm, c: 105 mm



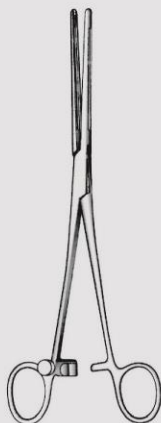


Cardiovascular Forceps
 Lung Grasping Forceps, Blood Vessel Clamps
 Lungenfasszangen, Gefassklemmen
 Pinzas-Clamps p/pulmon, Clamps p/vasos



Lovelace
 VBD323020
 20 cm / 8"

Lovelace
 VBD323520
 20 cm / 8"
 Laterally Curved



Johns Hopkins
 22 cm / 8 3/4"



VBD324022



VBD324122

قلبي عروقي
 پنس ها



CE

SQS Certificate
 ISO 9001:2000
 ISO 13485:2003

371



Lung Surgery
Bronchus Clamps
Bronchusklemmen
Pinzas clamps para
bronquiales

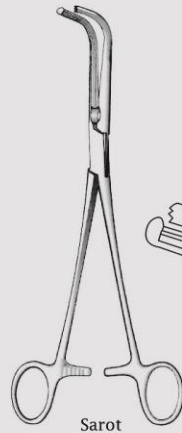
قلبي و عروقي
پنس ها



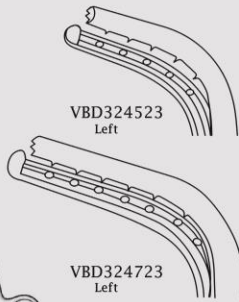
CE

SQS Certificate
ISO 9001:2000
ISO 13485:2003

372

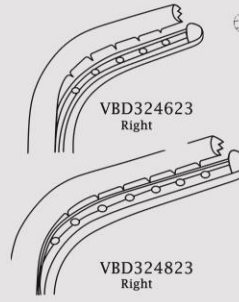


Sartorius
23 cm / 9"



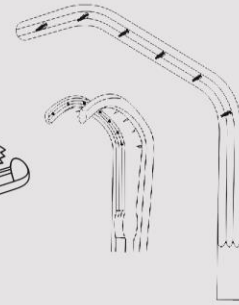
VBD324523
Left

VBD324723
Left

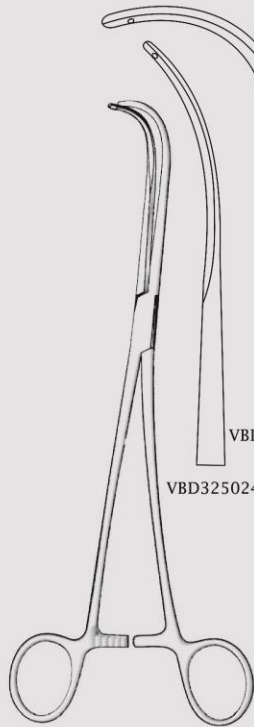


VBD324623
Right

VBD324823
Right



VBD326122

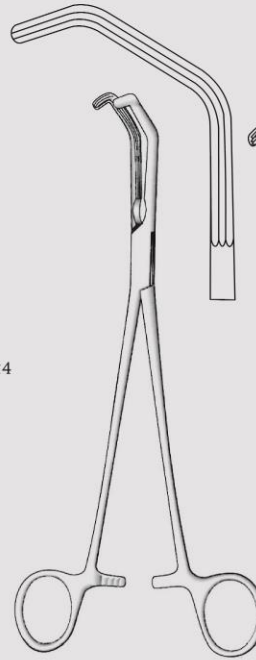


Semb
24 cm / 9 1/2"

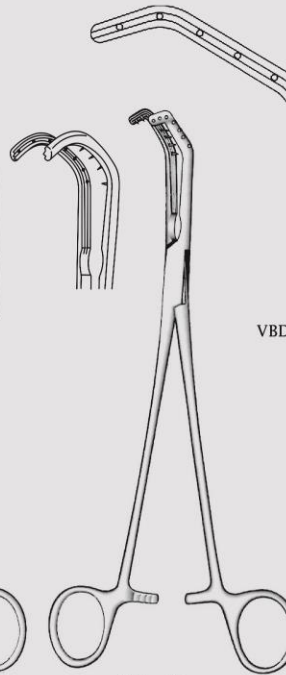


VBD325124

VBD325024



Price-Thomas
VBD325522
22 cm / 8 3/4"

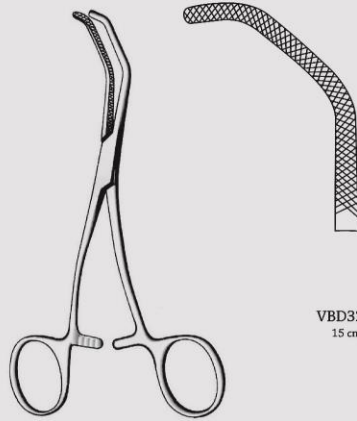


Price-Thomas
22 cm / 8 3/4"

VBD326022

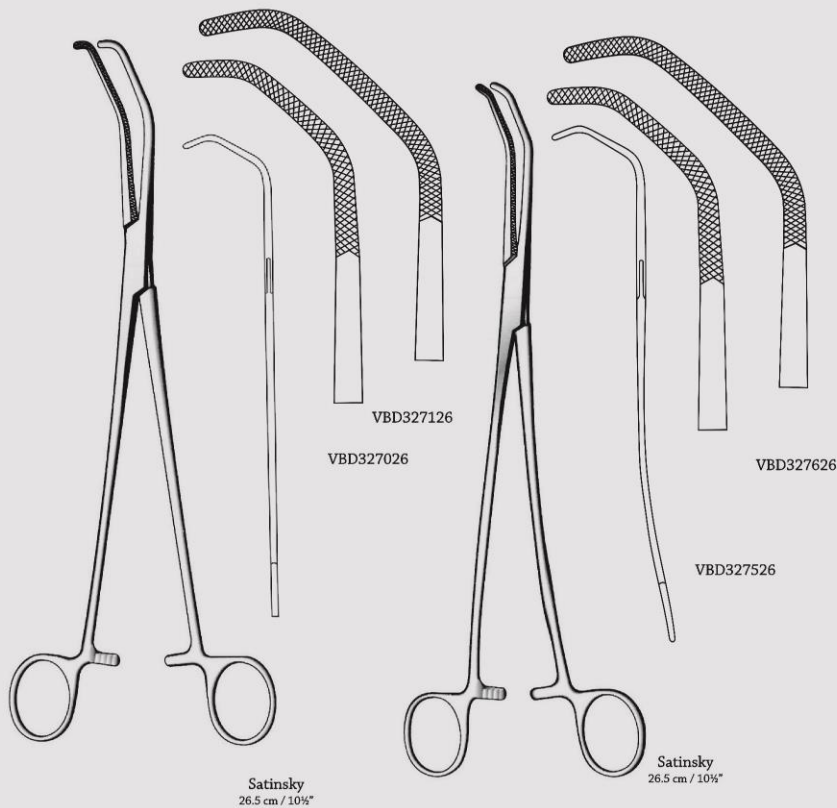


Cardiovascular Forceps
Blood Vessel Clamps
Gefassklemmen
Clamps p/vasos



VBD326515
15 cm / 6"

Baby-Satinsky



Satinsky
26.5 cm / 10 1/2"

Satinsky
26.5 cm / 10 1/2"

VBD327126

VBD327026

VBD327626

VBD327526

قلبي عروقي
پنس ها



CE

SQS Certificate
ISO 9001:2000
ISO 13485:2003

373



Lung Surgery
Blood Vessel Clamps
Gefassklemmen
Clamps p/vasos

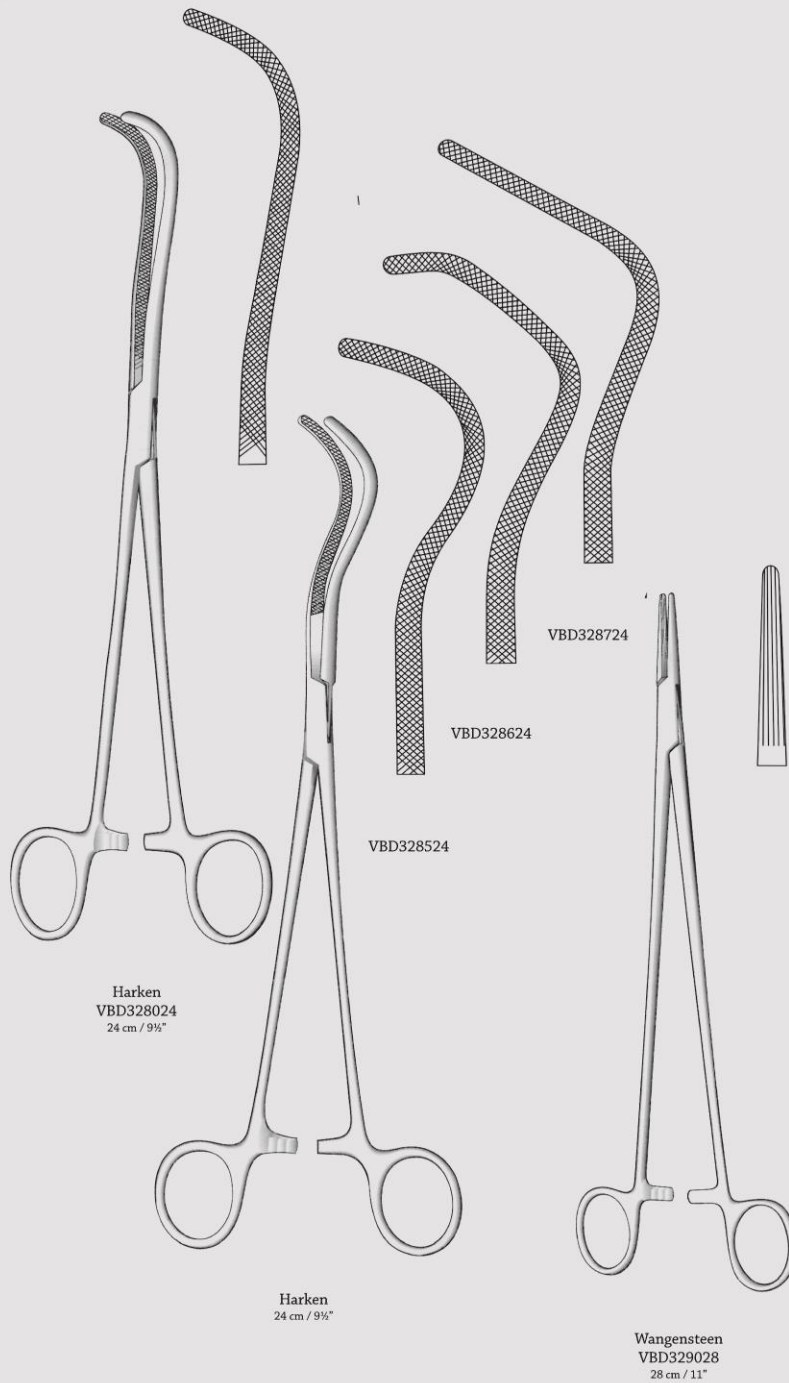
قلبي عروقي
پنس ها



CE

SQS Certificate
ISO 9001:2000
ISO 13485:2003

374

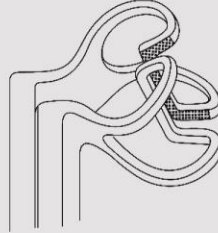




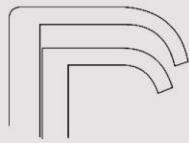
Lung Surgery
Aorta Clamps
Aortaklemmen
Clamps aorta



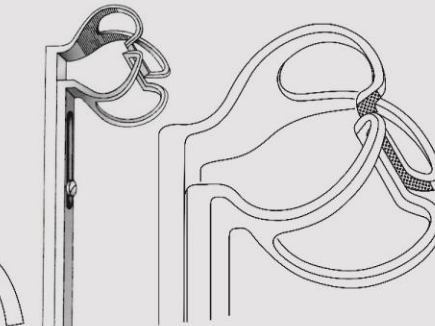
VBD329515
15 cm / 6"
14 mm



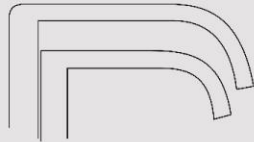
VBD330120
190 x 19 mm



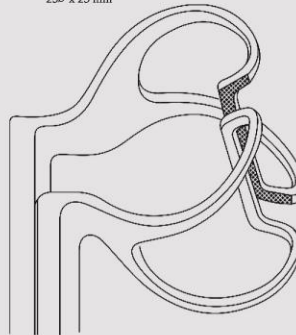
VBD329520
20 cm / 8"
18 mm



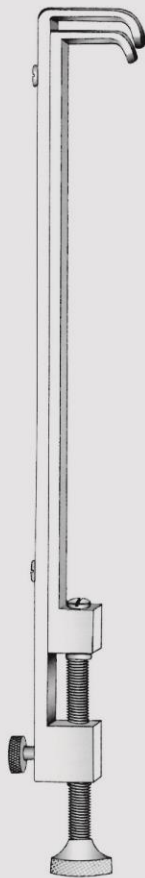
VBD330220
250 x 25 mm



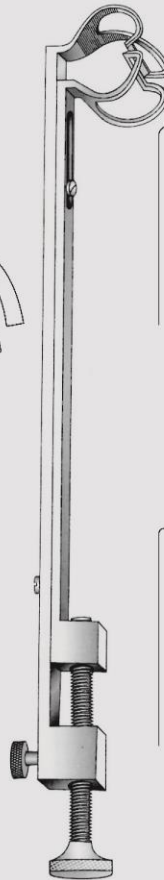
VBD329525
25 cm / 10"
23 mm



VBD330320
320 x 32 mm



Blalock



Johns Hopkins
20 cm / 8"

قلبي عروقي
كلمپ ها



CE

SQS Certificate
ISO 9001:2000
ISO 13485:2003

375



Tissue Forceps
Atrauma Tissue Forceps
Atrauma Pinzetten
Pinzas de diseccion Atrauma

قلبي عروقي
پنست ها



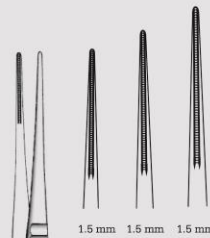
CE

SQS Certificate
ISO 9001:2000
ISO 13485:2003

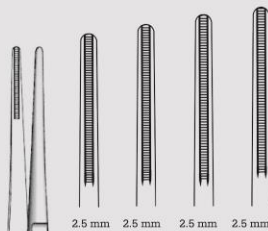
376

Toothing according to De Bakey:

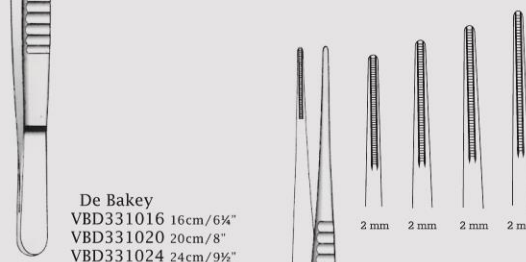
The traditional ATRAUMA clamps.
Apart from Cardio-Vascular Surgery,
They are also approved for other
atraumatic application and surgery
techniques. Firm and precise seizing
of tissues. Safe and delicately controlled
clamping effect.



1.5 mm 1.5 mm 1.5 mm



2.5 mm 2.5 mm 2.5 mm 2.5 mm



2 mm 2 mm 2 mm 2 mm

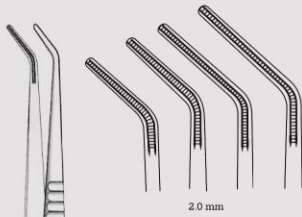
De Bakey
VBD331016 16cm/6¼"
VBD331020 20cm/8"
VBD331024 24cm/9½"

De Bakey
VBD330516 16cm/6¼"
VBD330520 20cm/8"
VBD330524 24cm/9½"
VBD330530 30cm/12"

De Bakey
VBD331516 16cm/6¼"
VBD331520 20cm/8"
VBD331524 24cm/9½"
VBD331530 30cm/12"

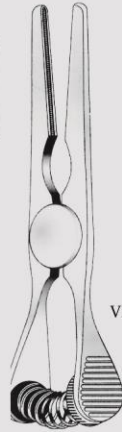


Tissue Forceps
 Vascular Forceps, Bulldog Clamps
 Gefäßpinzetten, Bulldogklemmen
 Pinzas de dissecion Vascular, Clamps Bulldog



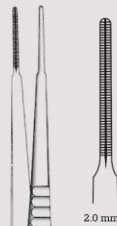
2.0 mm

De Bakey
 VBD332016 16cm/6¼"
 VBD332020 20cm/8"
 VBD332024 24cm/9¼"
 VBD332030 30cm/12"



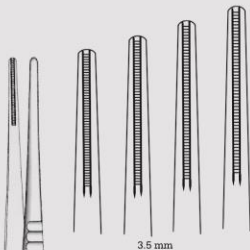
Glover

VBD333506 6 cm / 2½"
 VBD333507 7 cm / 2¾"
 VBD333509 9 cm / 3¼"
 VBD333511 11 cm 4½"



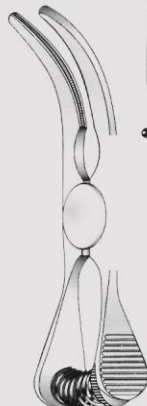
2.0 mm

Cooley
 VBD333016 16cm/6¼"
 VBD333020 20cm/8"



3.5 mm

De Bakey
 VBD332516 16cm/6¼"
 VBD332520 20cm/8"
 VBD332524 24cm/9¼"
 VBD332530 30cm/12"



Glover

VBD334005 5.5 cm / 2¼"
 VBD334006 6.5 cm / 2¾"
 VBD334008 8.5 cm / 3¾"
 VBD334010 10.5 cm / 4½"



CE

SQS Certificate
 ISO 9001:2000
 ISO 13485:2003

377



Cardiovascular Forceps
 Atrauma Bulldog Clamps and Atrauma Hemostatic Forceps
 Atrauma Bulldogklemmen und Atrauma Arterienklemmen
 Pinças para Bulldog Clamps Y hemostaticas Atrauma

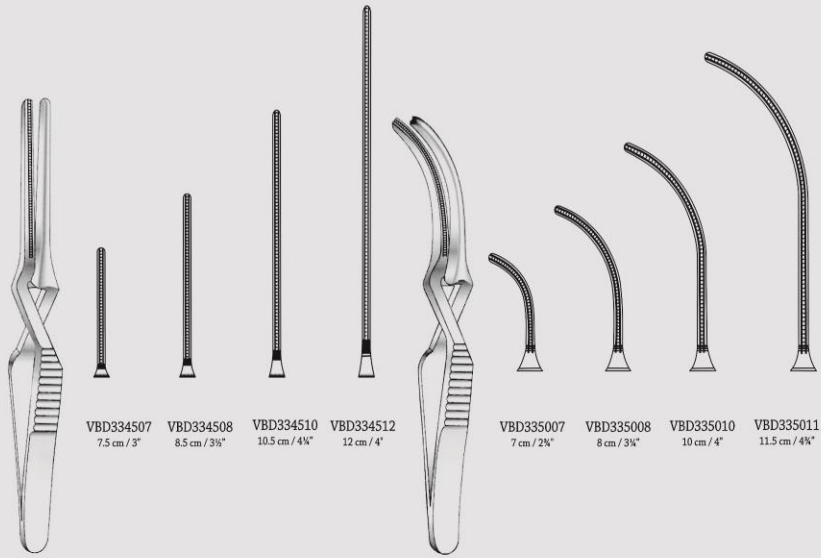
قلبي عروقي
 بولداگ ها
 پنس ها



CE

SQS Certificate
 ISO 9001:2000
 ISO 13485:2003

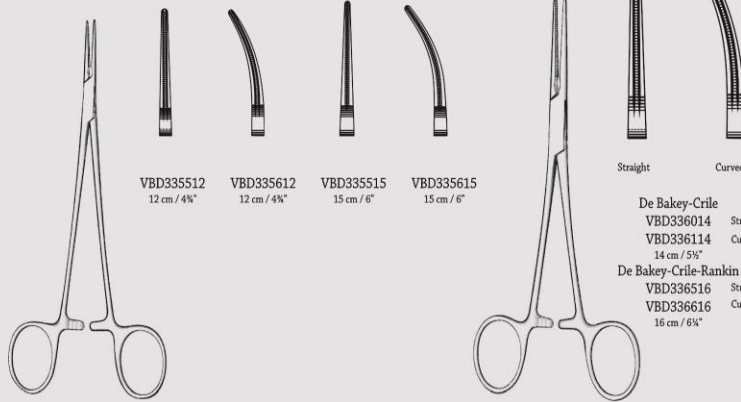
378



VBD334507 7.5 cm / 3"	VBD334508 8.5 cm / 3 1/4"	VBD334510 10.5 cm / 4 1/4"	VBD334512 12 cm / 4"	VBD335007 7 cm / 2 3/4"	VBD335008 8 cm / 3"	VBD335010 10 cm / 4"	VBD335011 11.5 cm / 4 1/2"
--------------------------	------------------------------	-------------------------------	-------------------------	----------------------------	------------------------	-------------------------	-------------------------------

De Bakey

De Bakey



VBD335512 12 cm / 4 3/4"	VBD335612 12 cm / 4 3/4"	VBD335515 15 cm / 6"	VBD335615 15 cm / 6"
-----------------------------	-----------------------------	-------------------------	-------------------------

Straight Curved

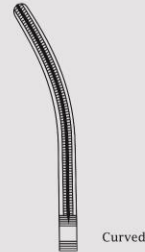
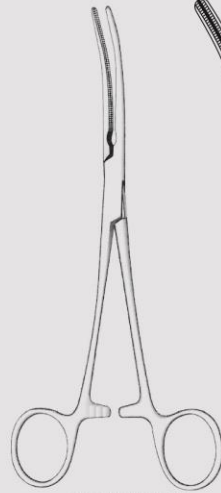
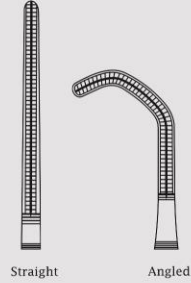
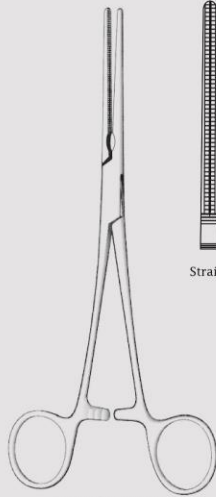
De Bakey-Crile
 VBD336014 Straight
 VBD336114 Curved
 14 cm / 5 1/2"

De Bakey-Crile-Rankin
 VBD336516 Straight
 VBD336616 Curved
 16 cm / 6 1/4"

De Bakey-Mosquito

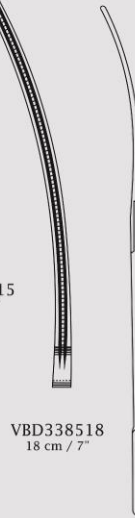
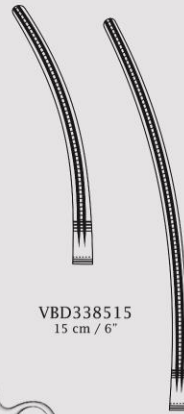
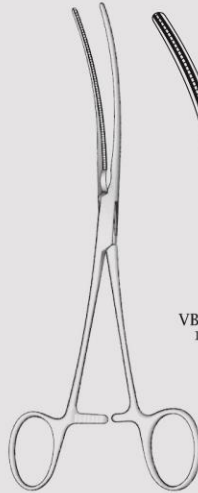
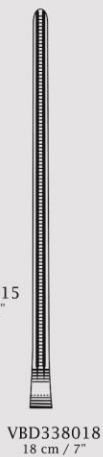
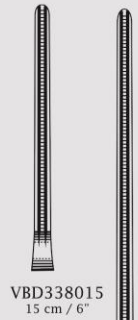
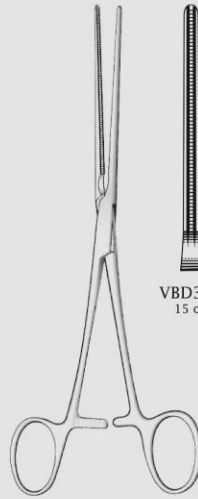


Cardiovascular Forceps
 Atrauma Haemostatic Forceps and
 Atrauma Cardiovascular Forceps
 Atrauma-Arterienklemmen und
 Atrauma Cardiovascular-Klemmen
 Atrauma hemostaticas Pinzas Y
 Atrauma Pinzas-Clamps
 Cardiovasculares



De Bakey-Pean
 VBD337016 16.5cm / 6½" VBD337116
 VBD337018 18.5cm / 7¼" VBD337118
 VBD337020 20.5cm / 8" VBD337120
 VBD337026 26cm / 10¼" VBD337126
 VBD337028 28cm / 11" VBD337128
 Straight Angled

De Bakey-Pean
 VBD337516 16.5cm / 6½"
 VBD337518 18.5cm / 7¼"
 VBD337520 20.5cm / 8"
 VBD337526 26cm / 10¼"
 VBD337528 28cm / 11"



Bainbridge
 Straight

Bainbridge
 Curved

VBD338015
 15 cm / 6"

VBD338018
 18 cm / 7"

VBD338515
 15 cm / 6"

VBD338518
 18 cm / 7"



CE

SQS Certificate
 ISO 9001:2000
 ISO 13485:2003

379



Cardiovascular Forceps
Atrauma Cardiovascular Forceps
Atrauma Cardiovascular-Klemmen
Atrauma Pinzas-clamps cardiovasculares

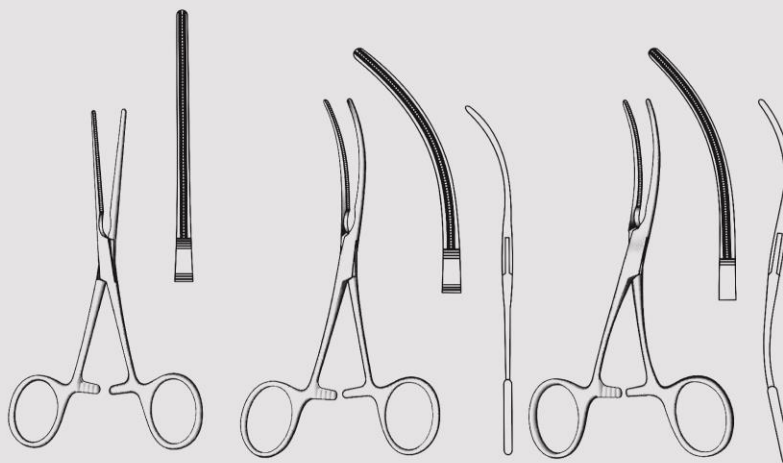
قلبي عروقي
پنس ها

ایزاد جراحی
دایموند

CE

SQS Certificate
ISO 9001:2000
ISO 13485:2003

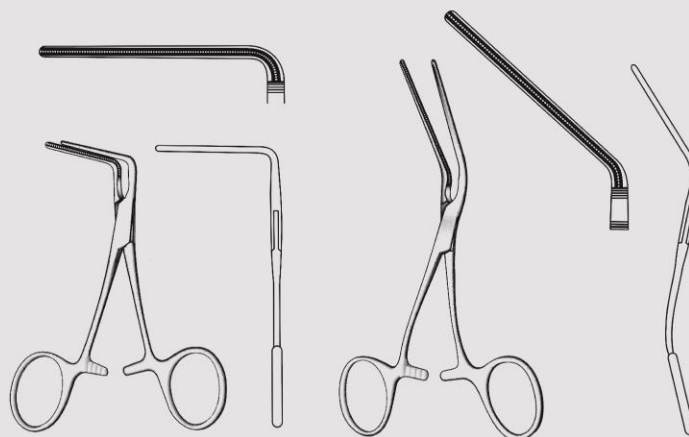
380



De Bakey
VBD339012
12 cm / 4 3/4"

De Bakey
VBD339511
11 cm / 4 1/4"

De Bakey
VBD340112
12 cm / 4 3/4"

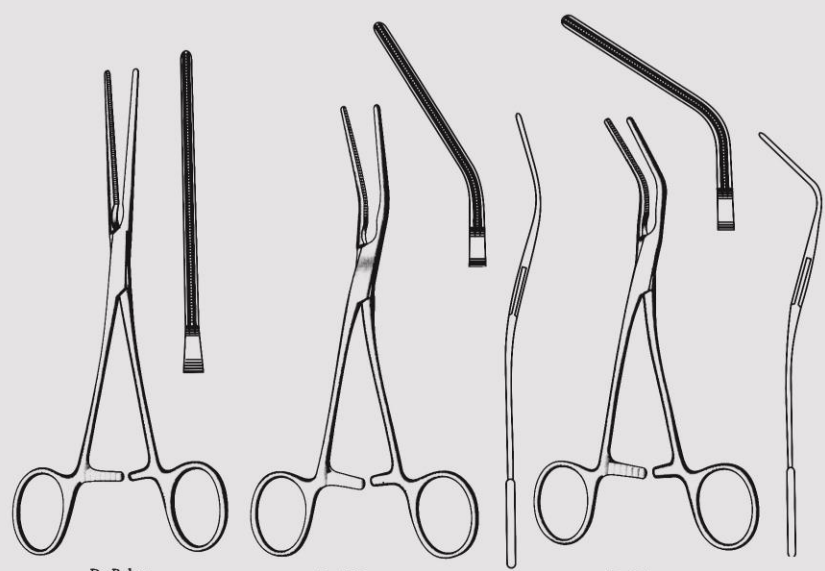


De Bakey
VBD340510
10 cm / 4"

De Bakey
VBD341513
13 cm / 5 1/4"



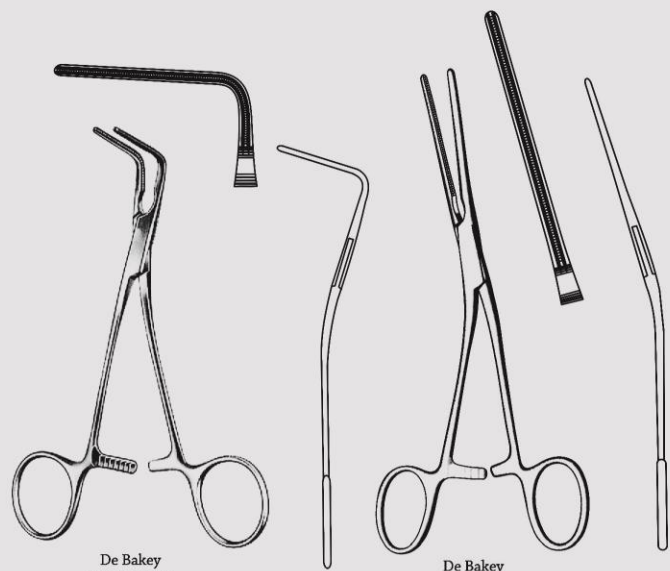
Cardiovascular Forceps
 Atrauma Cardiovascular Forceps
 Atrauma Cardiovascular - Klemmen
 Atrauma Pinzas-clamps cardiovasculares



De Bakey
 VBD342017
 17 cm / 6 3/4"

De Bakey
 VBD342516
 16 cm / 6 1/4"

De Bakey
 VBD343015
 15 cm / 6"



De Bakey
 VBD343515
 15 cm / 6"

De Bakey
 VBD344017
 17 cm / 6 3/4"

قلبي عروقي
 پنس ها



CE

SQS Certificate
 ISO 9001:2000
 ISO 13485:2003

381



Cardiovascular Forceps
 Atrauma Cardiovascular Forceps
 Atrauma Cardiovascular-Klemmen
 Atrauma Pinzas-clamps cardiovasculares

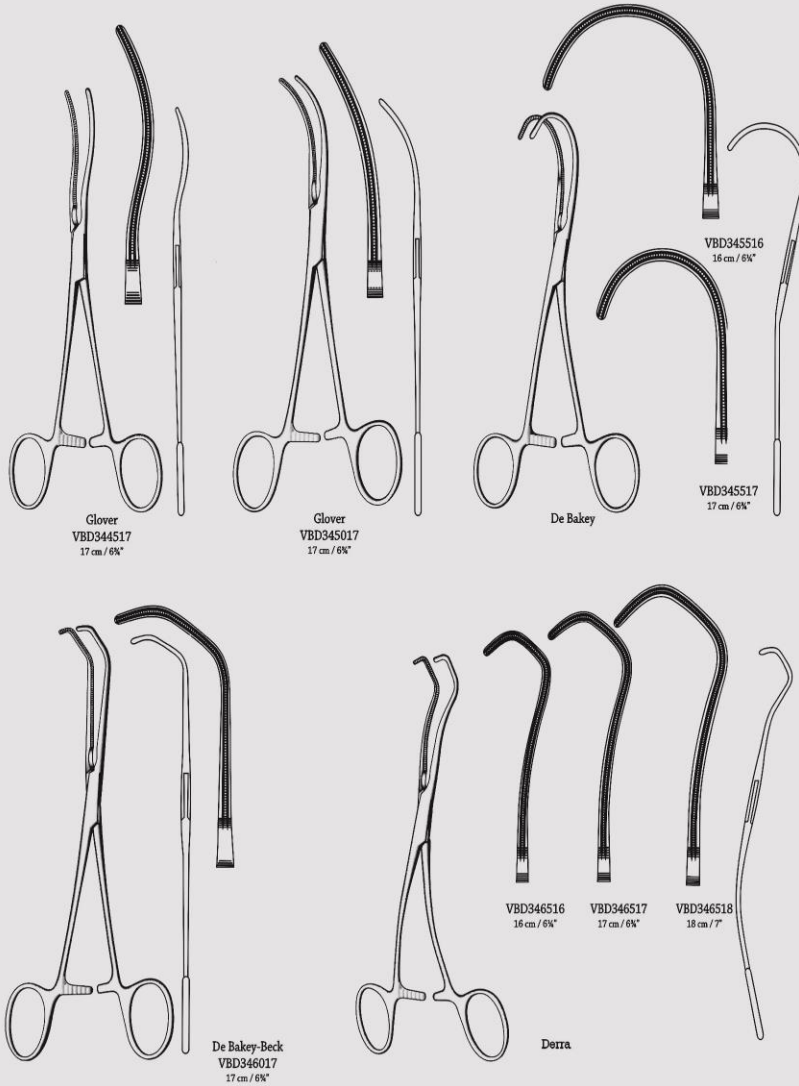
قلبي عروقي
 پنس ها



CE

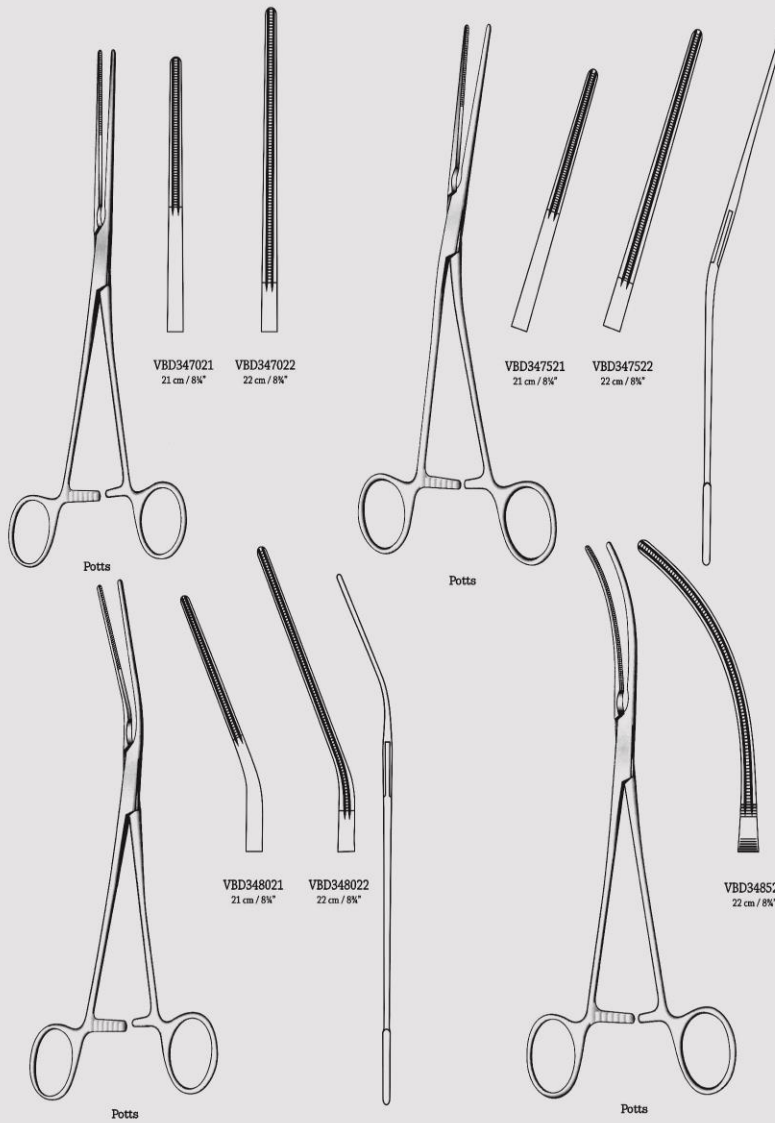
SQS Certificate
 ISO 9001:2000
 ISO 13485:2003

382





Cardiovascular Forceps
Atrauma Cardiovascular Forceps
Atrauma Cardiovascular - Klemmen
Atrauma Pinzas- Clamps Cardiovasculares



قلبي عروقي
پنس ها



CE

SQS Certificate
ISO 9001:2000
ISO 13485:2003

383



Cardiovascular Forceps
Atrauma Cardiovascular Forceps
Atrauma Cardiovascular-Klemmen
Atrauma Pinzas-clamps cardiovasculares

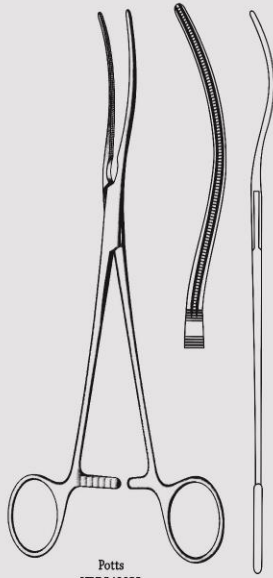
قلبي عروقي
پنس ها



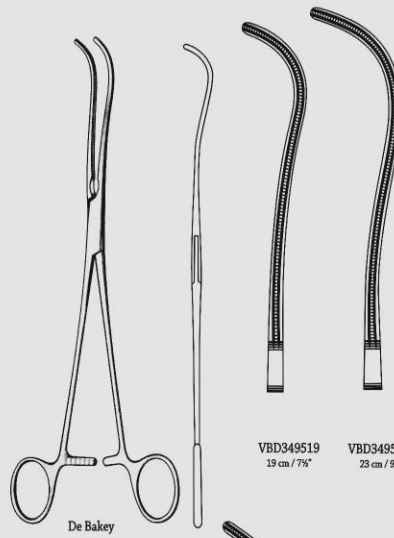
CE

SQS Certificate
ISO 9001:2000
ISO 13485:2003

384

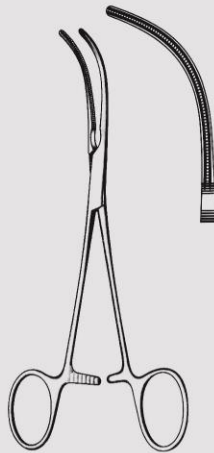


Potts
VBD349022
22 cm / 8 1/2"

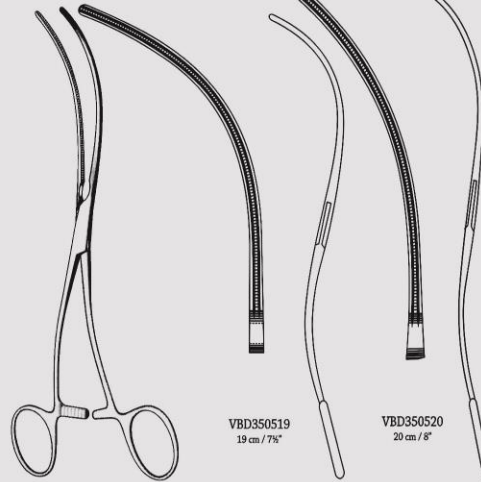


VBD349519
19 cm / 7 1/2"

VBD349523
23 cm / 9"



De Bakey
VBD350116
16 cm / 6 1/4"



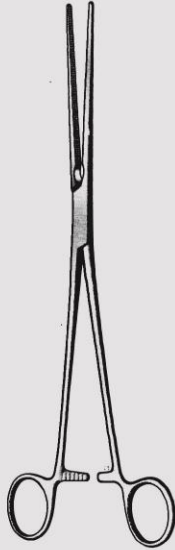
VBD350519
19 cm / 7 1/2"

VBD350520
20 cm / 8"

De Bakey



Cardiovascular Forceps
Atrauma Cardiovascular Forceps
Atrauma Cardiovascular-Klemmen
Atrauma Pinzas-Clamps Cardiovasculares



Potts
Straight



VBD351021
21.5 cm / 8½"



VBD351023
23 cm / 9"



VBD351027
27 cm / 10½"



VBD351031
31.5 cm / 12½"



Potts
Curved



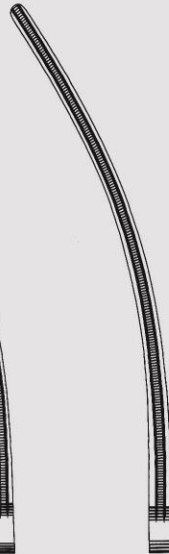
VBD351521
21.5 cm / 8½"



VBD351523
23 cm / 9"



VBD351527
27 cm / 10½"



VBD351531
31.5 cm / 12½"

قلبي عروقي
پنس ها



CE

SQS Certificate
ISO 9001:2000
ISO 13485:2003

385



Cardiovascular Forceps
Atrauma Cardiovascular Forceps
Atrauma Cardiovascular - Klemmen
Atrauma Pinzas-Clamps Cardiovasculares

قلبي عروقي
پنس ها



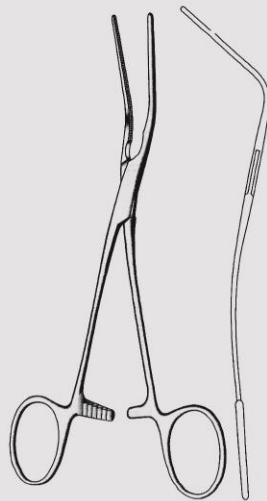
CE

SQS Certificate
ISO 9001:2000
ISO 13485:2003

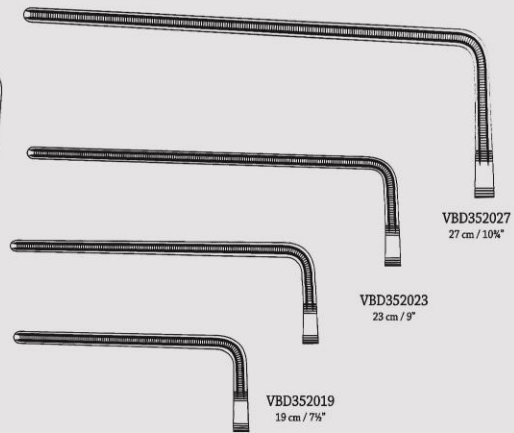
386



De Bakey



De Bakey

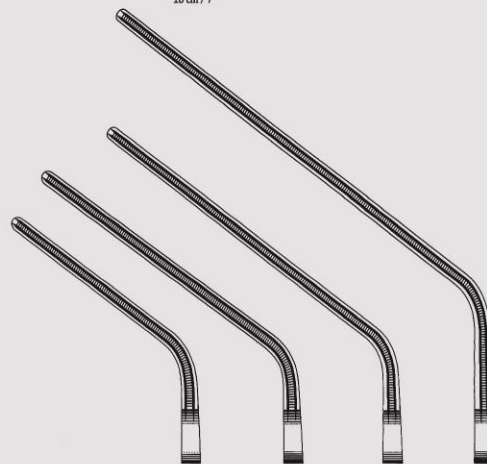


VBD352019
19 cm / 7 1/2"

VBD352023
23 cm / 9"

VBD352027
27 cm / 10 1/2"

VBD352018
18 cm / 7"



VBD352520
20 cm / 8"

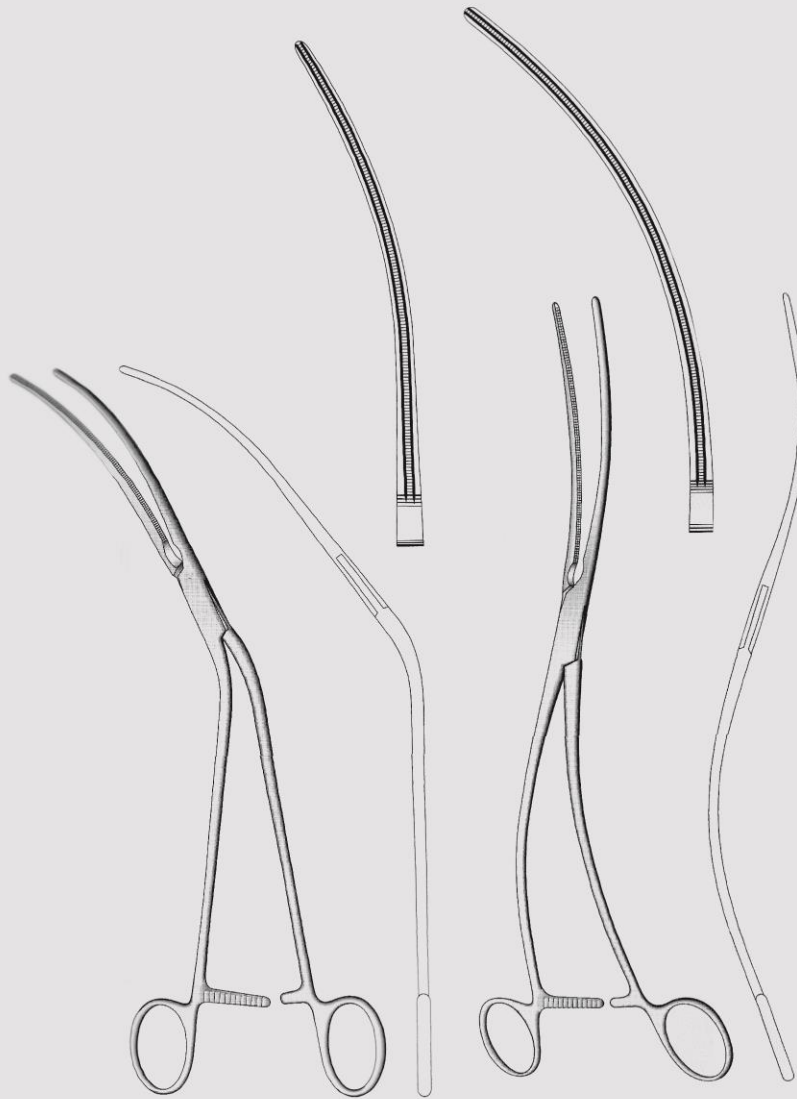
VBD352521
21 cm / 8 1/4"

VBD352525
25 cm / 10"

VBD352529
29 cm / 11 1/4"



Cardiovascular Forceps
Atrauma Cardiovascular Forceps
Atrauma Cardiovascular-Klemmen
Atrauma Pinzas-Clamps Cardiovasculares



De Bakey
VBD353028
28 cm / 11"

De Bakey
VBD353530
30 cm / 12"

قلبي عروقي
پنس ها



CE

SQS Certificate
ISO 9001:2000
ISO 13485:2003

387



Cardiovascular Forceps
Atrauma Cardiovascular Forceps
Atrauma Cardiovascular - Klemmen
Atrauma Pinzas-Clamps Cardiovasculares

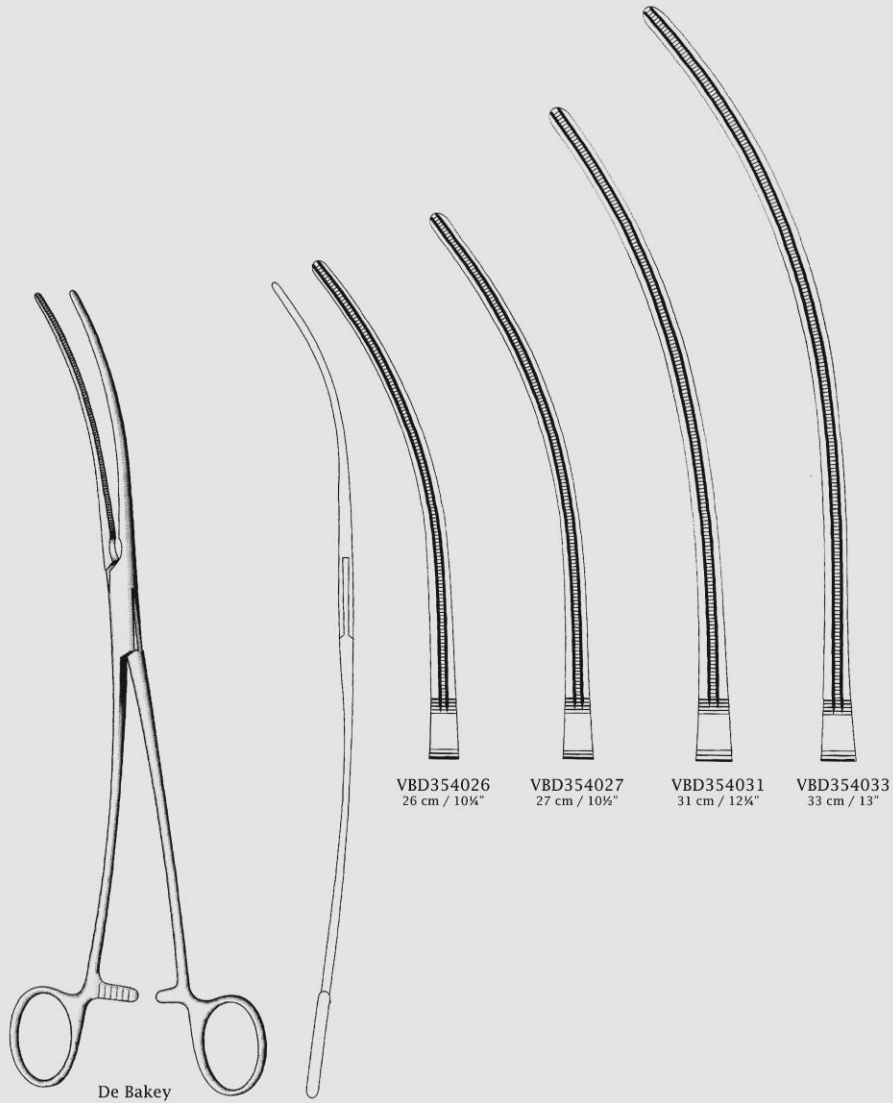
قلبي عروقي
پنس ها



CE

SQS Certificate
ISO 9001:2000
ISO 13485:2003

388



De Bakey

VBD354026
26 cm / 10 1/4"

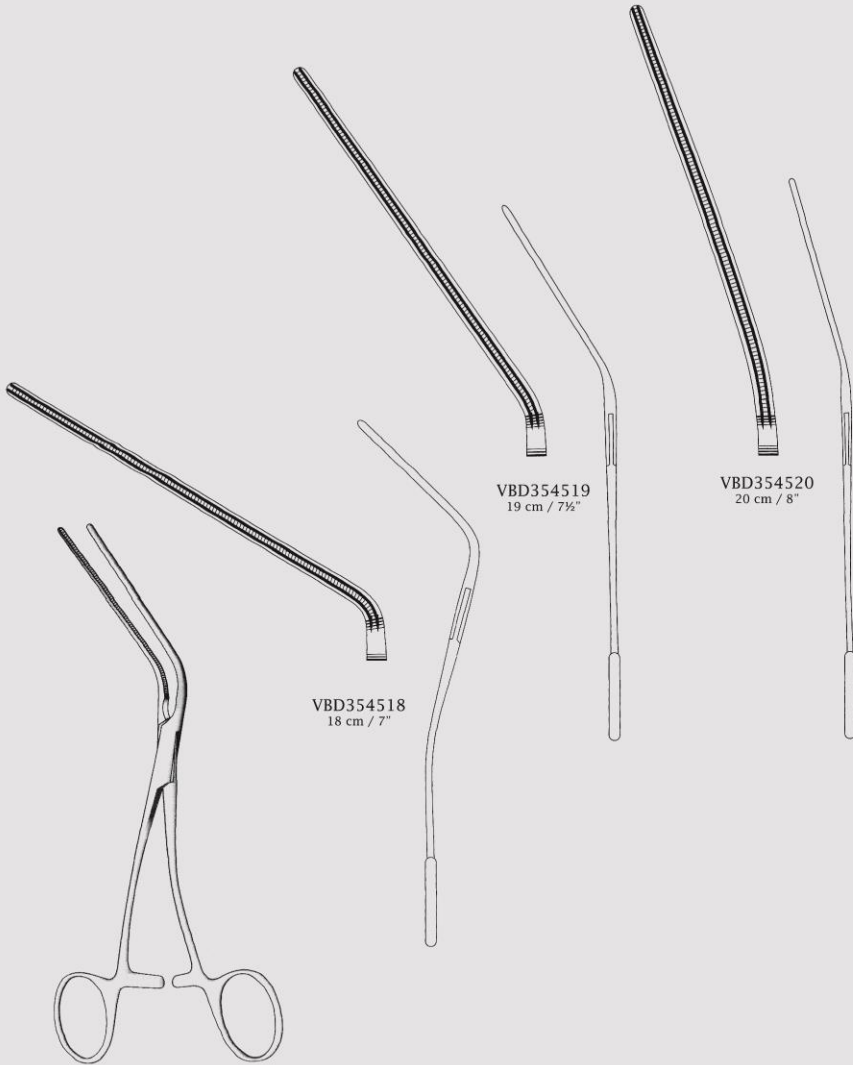
VBD354027
27 cm / 10 3/4"

VBD354031
31 cm / 12 1/4"

VBD354033
33 cm / 13"



Cardiovascular Forceps
Atrauma Cardiovascular Forceps
Atrauma Cardiovascular-Klemmen
Atrauma Pinzas-clamps cardiovasculares



Leland-Jones

قلبي عروقي
پنس ها



CE

SQS Certificate
ISO 9001:2000
ISO 13485:2003

389



Cardiovascular Forceps
Atrauma Cardiovascular Forceps
Atrauma Cardiovascular-Klemmen
Atrauma Pinzas-clamps cardiovasculares

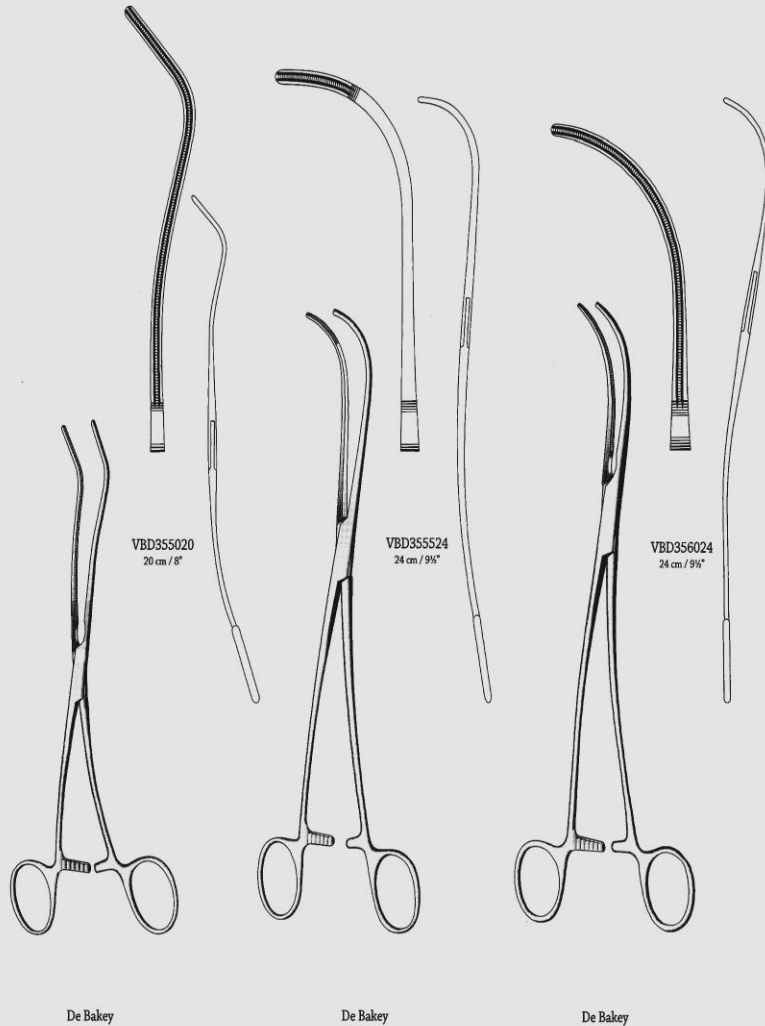
قلبي عروقي
پنس ها



CE

SQS Certificate
ISO 9001:2000
ISO 13485:2003

390





Cardiovascular Forceps
Atrauma Cardiovascular Forceps
Atrauma Cardiovascular-Klemmen
Atrauma Pinzas-clamps cardiovasculares

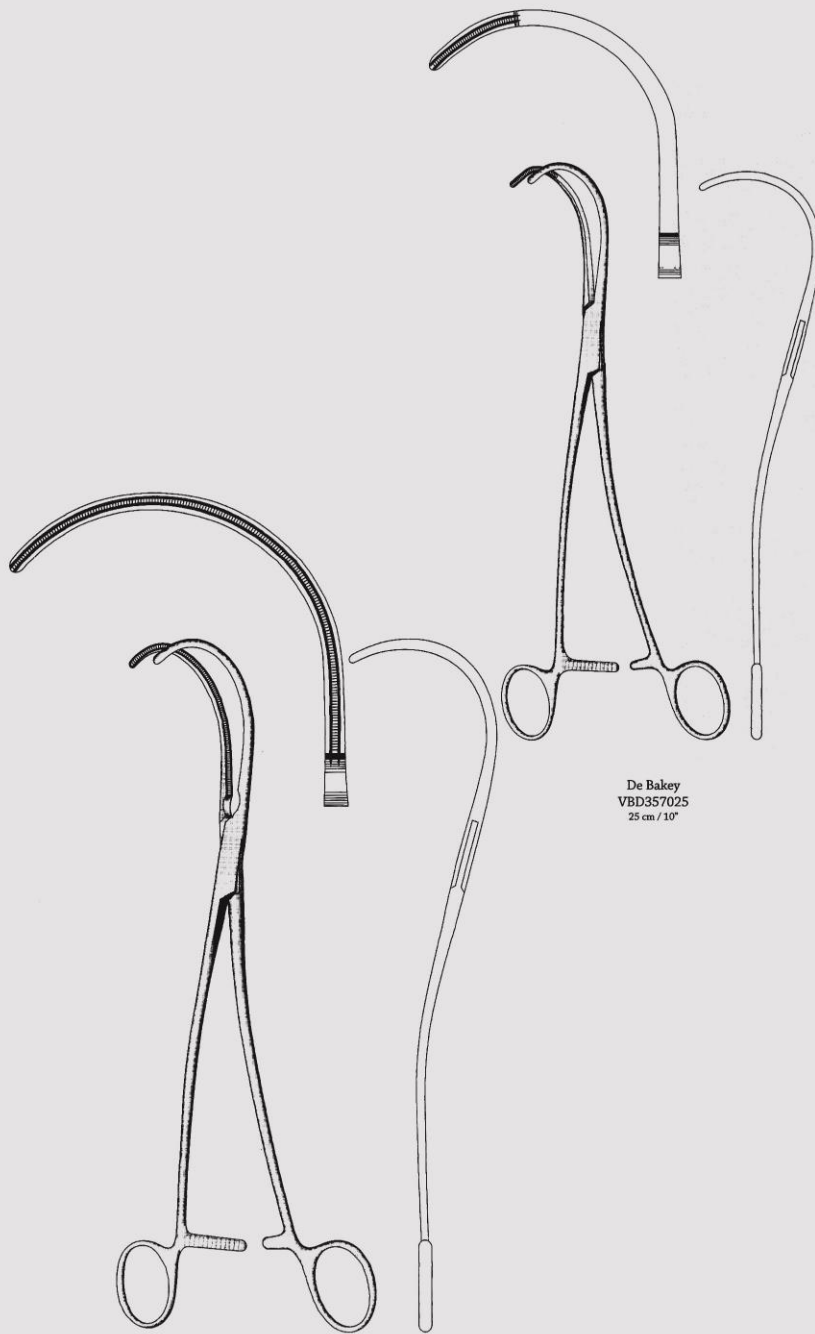
قلبی عروقی
پنس ها



CE

SQS Certificate
ISO 9001:2000
ISO 13485:2003

391



De Bakey
VBD357025
25 cm / 10"

De Bakey
VBD356525
25 cm / 10"



Cardiovascular Forceps
Tangential Occlusion Clamps
Tagentialklemmen
Pinzas para occlusion tangencial

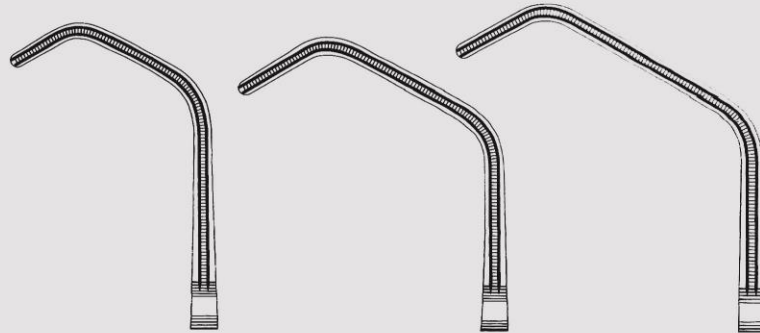
قلبي عروقي
پنس ها



CE

SQS Certificate
ISO 9001:2000
ISO 13485:2003

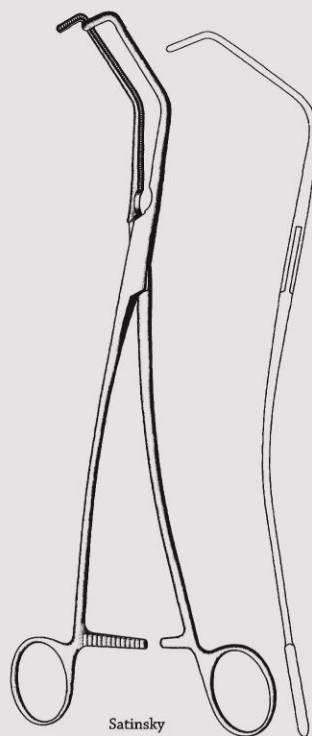
392



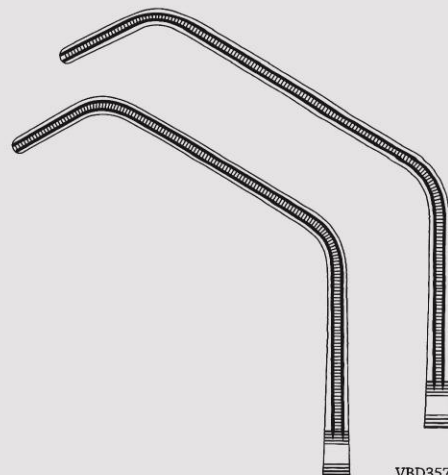
VBD357520
20.5 cm / 8"

VBD357524
24 cm / 9 1/2"

VBD357525
25 cm / 10"



Satinsky

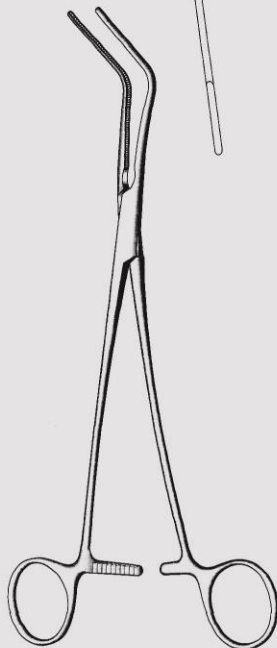
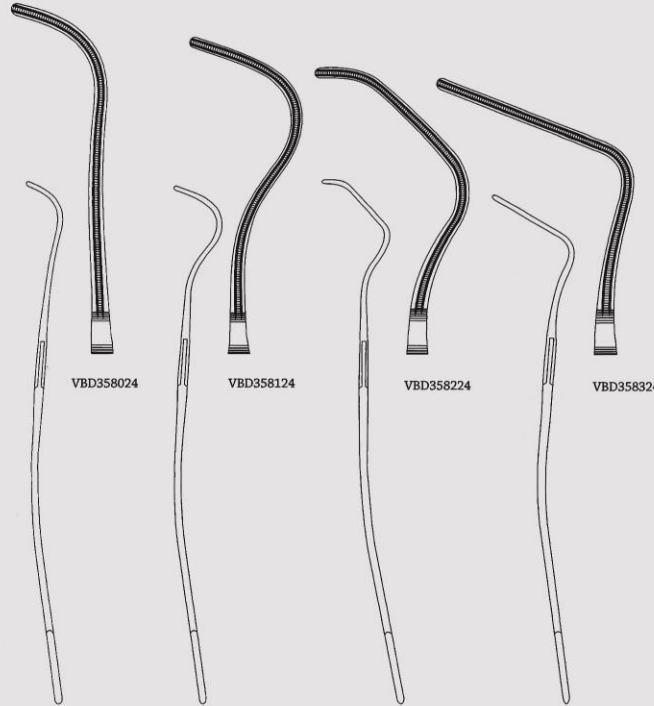


VBD357526
26.5 cm / 10 1/2"

VBD357527
27.5 cm / 11"



Cardiovascular Forceps
Auricle Clamps
Aurikkelklemmen
Pinzas para auricula



Harken
24 cm / 9 1/2"

قلبي عروقي
پنس



CE

SQS Certificate
ISO 9001:2000
ISO 13485:2003

393



Cardiovascular Forceps
Bronchus Clamps
Bronchusklemmen
Pinzas bronquiales

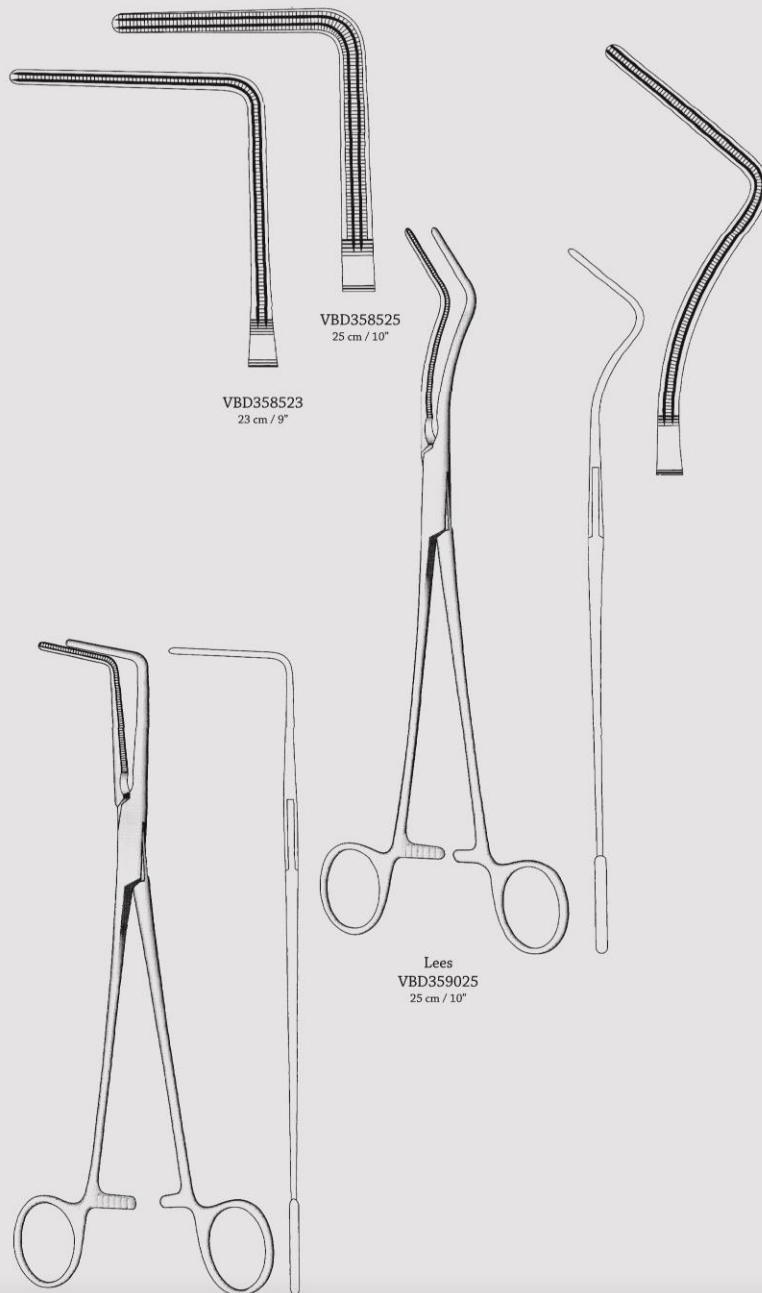
قلبي عروقي
پنس ها



CE

SQS Certificate
ISO 9001:2000
ISO 13485:2003

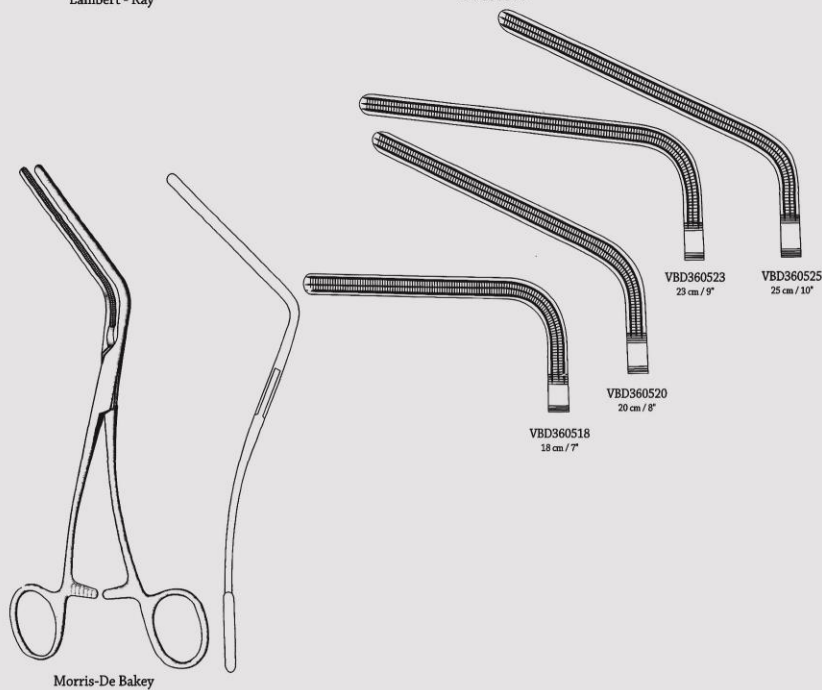
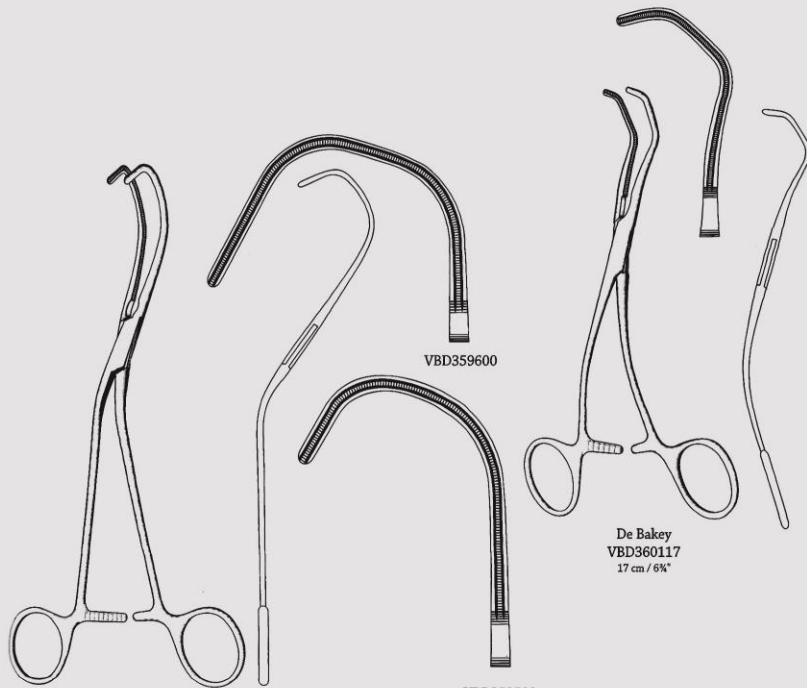
394



www.Diamondmed.ir



Cardiovascular Forceps
Anastomosis Clamps, Aortic Clamps
Anastomosenklemmen, Aortaklemmen
Pinzas para anastomosis, Pinzas aorticas



قلبي عروقي
پنس ها



CE

SQS Certificate
ISO 9001:2000
ISO 13485:2003

395



Cardiovascular Forceps
Aneurysm Clamps
Aneurysmaklemmen
Pinzas para aneurisma

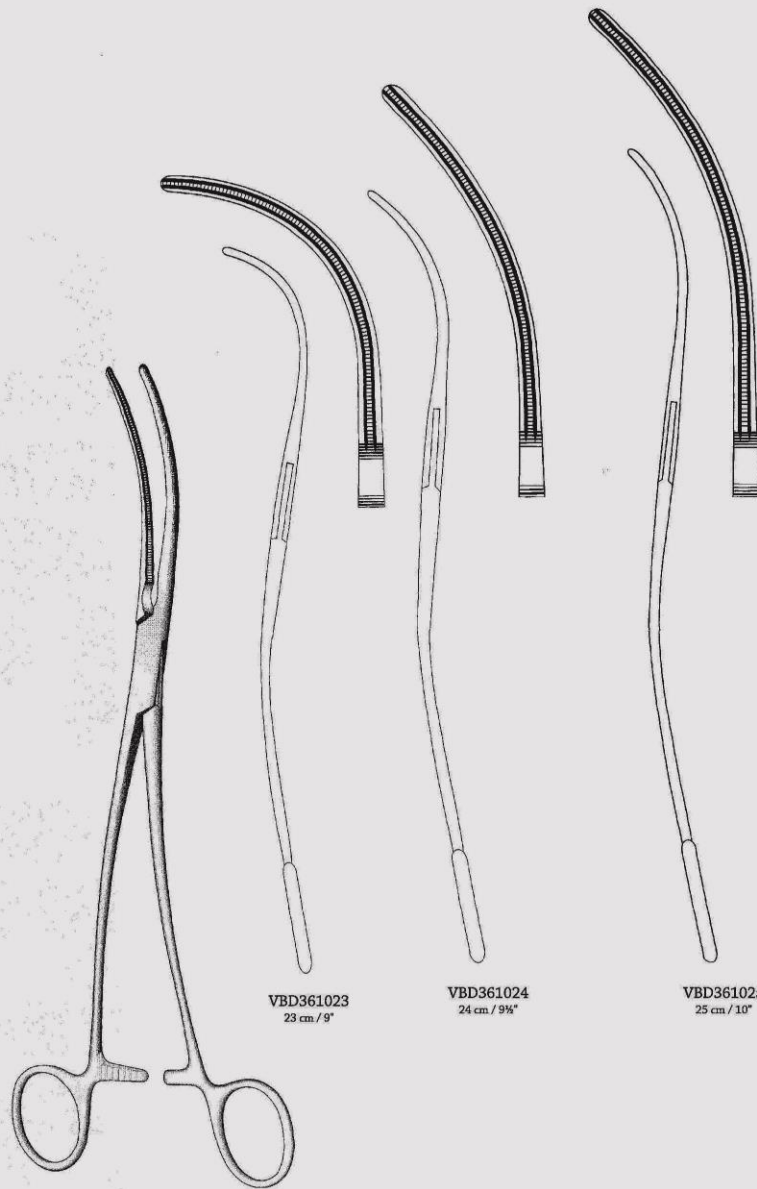
قلبي عروقي
پنس ها



CE

SQS Certificate
ISO 9001:2000
ISO 13485:2003

396



VBD361023
23 cm / 9"

VBD361024
24 cm / 9 1/2"

VBD361025
25 cm / 10"

De Bakey-Bahnsen



Cardiovascular Forceps

Neonatal and Pediatric Vascular Clamps, Very Delicate Patterns
Neonatal- und Kinder Gefäßklammern, Extraktive Modelle
Pinza-Clamp vascolare per neonati e Pediatrica, Modello very delicate



VBD361512
12 cm / 4 3/4"



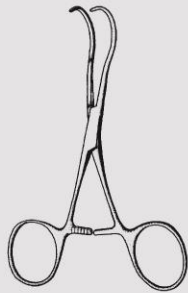
VBD361612
12 cm / 4 3/4"



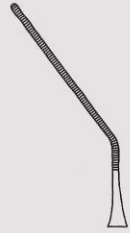
VBD361712
12 cm / 4 3/4"



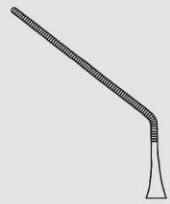
VBD361812
12 cm / 4 3/4"



Castaneda



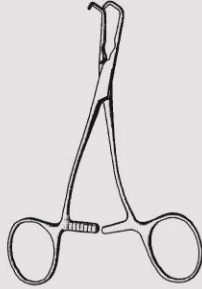
VBD361913
13 cm / 5"



VBD362013
13 cm / 5"



VBD362111
11 cm / 4 3/8"



VBD362514
14 cm / 5 1/2"



VBD362614
14 cm / 5 1/2"



VBD362714
14 cm / 5 1/2"



VBD362813
13 cm / 5"



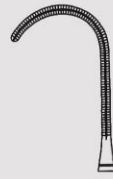
VBD362914
14 cm / 5 1/2"



VBD363013
13 cm / 5"



VBD363113
13 cm / 5"



VBD363214
14 cm / 5 1/4"



VBD363313
13.5 cm / 5 1/4"

قلبي عروقي
پنس ها



SQS Certificate
ISO 9001:2000
ISO 13485:2003

397



Cardiovascular Forceps
Pediatric Vascular Clamps
Kinder Gefäßklemmen
Pinzas vasculares pediátricas

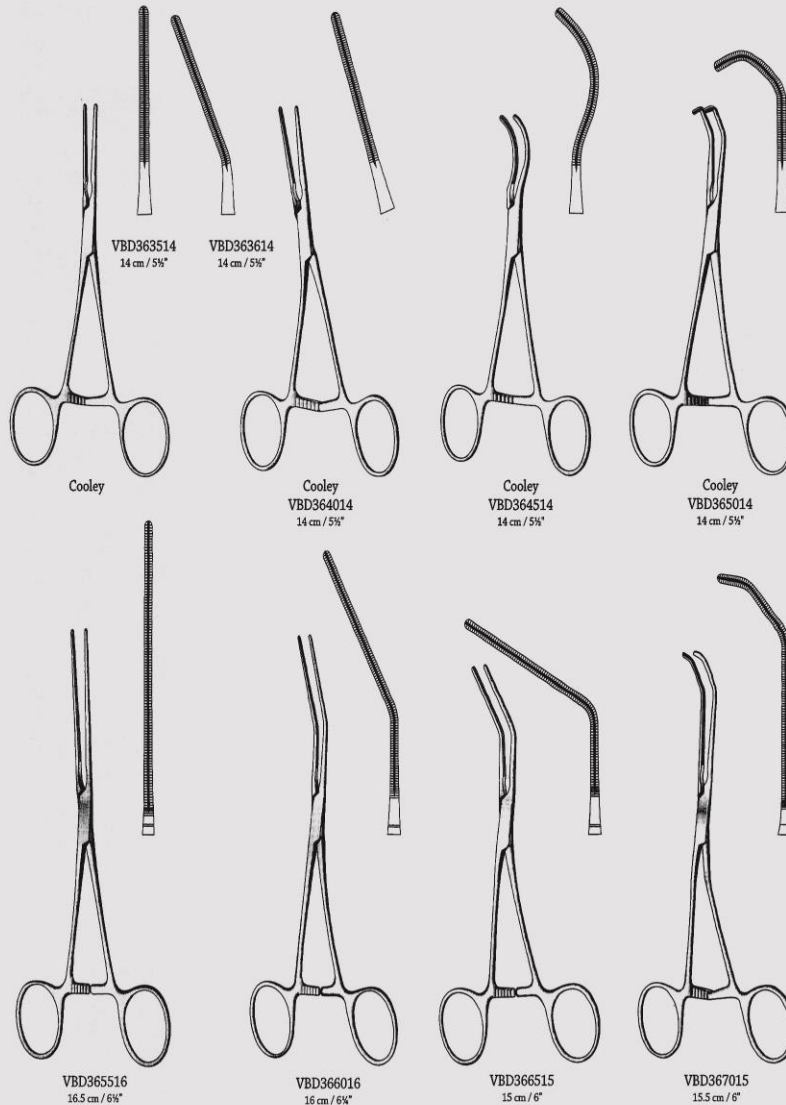
قلبی عروقی
پنس ها



CE

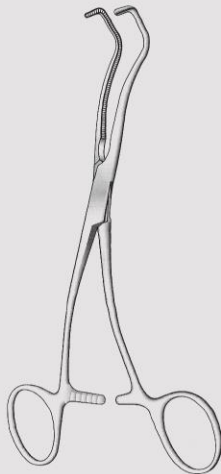
SQS Certificate
ISO 9001:2000
ISO 13485:2003

398





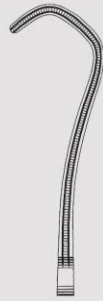
Cardiovascular Forceps
Anastomosis Clamps
Anastomosenklemmen
Pinzas para anastomosis



Cooley-Derra



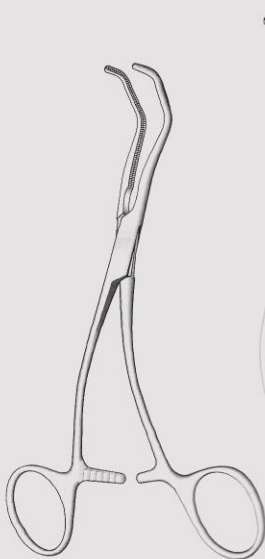
VBD367516
16 cm / 6 1/4"



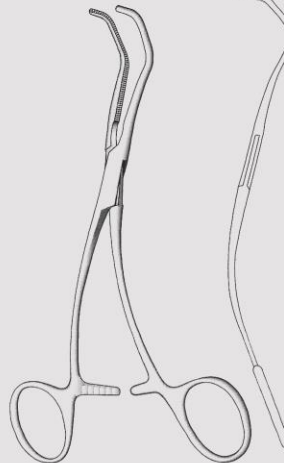
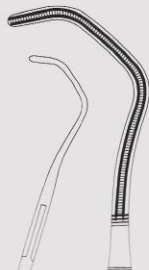
VBD367517
17 cm / 6 3/4"



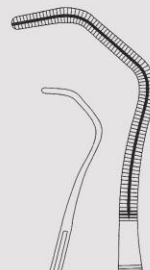
VBD367518
18 cm / 7"



Beck
VBD368017
17 cm / 6 3/4"



Cooley
VBD368516
16 cm / 6 1/4"



قلبي عروقي
پنس ها



CE

SQS Certificate
ISO 9001:2000
ISO 13485:2003

399



Cardiovascular Forceps

Atrauma Cardiovascular Forceps
Atrauma Cardiovascular-Klemmen
Atrauma Pinzas-clamps cardiovasculares

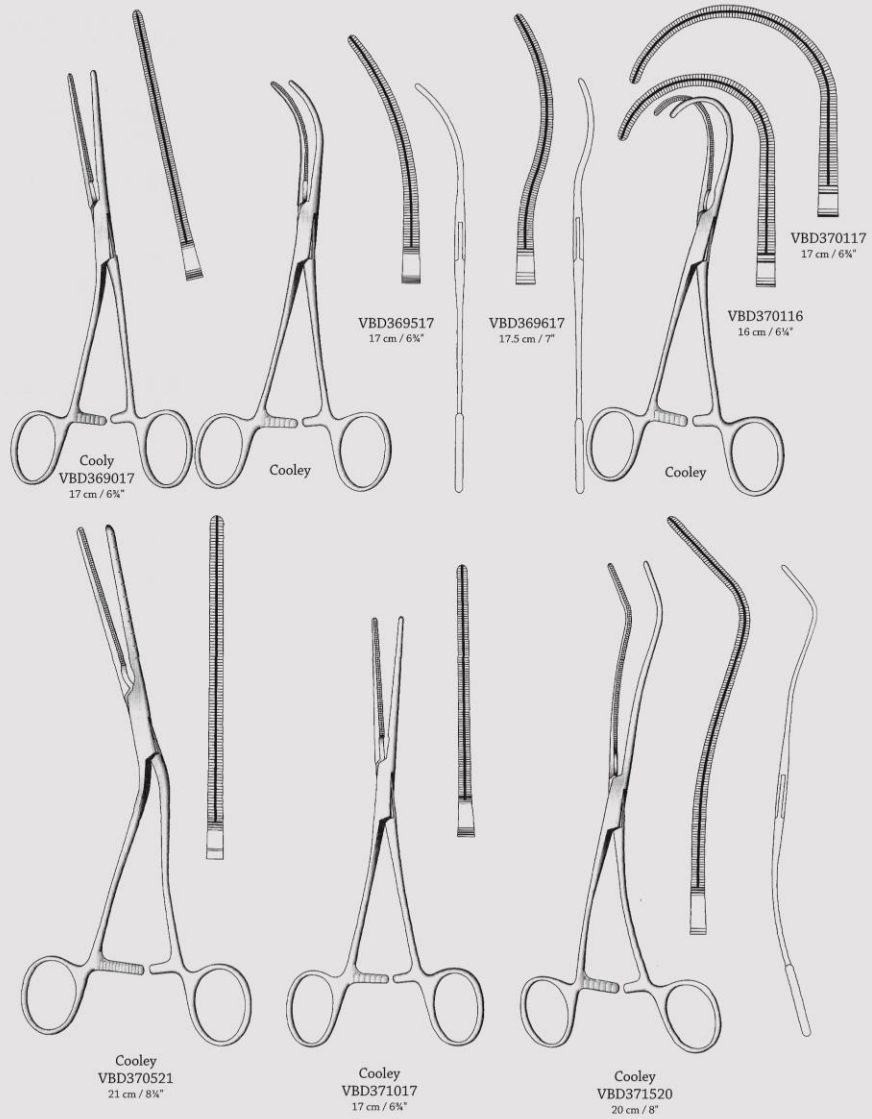
قلب و عروق
پنس ها



CE

SQS Certificate
ISO 9001:2000
ISO 13485:2003

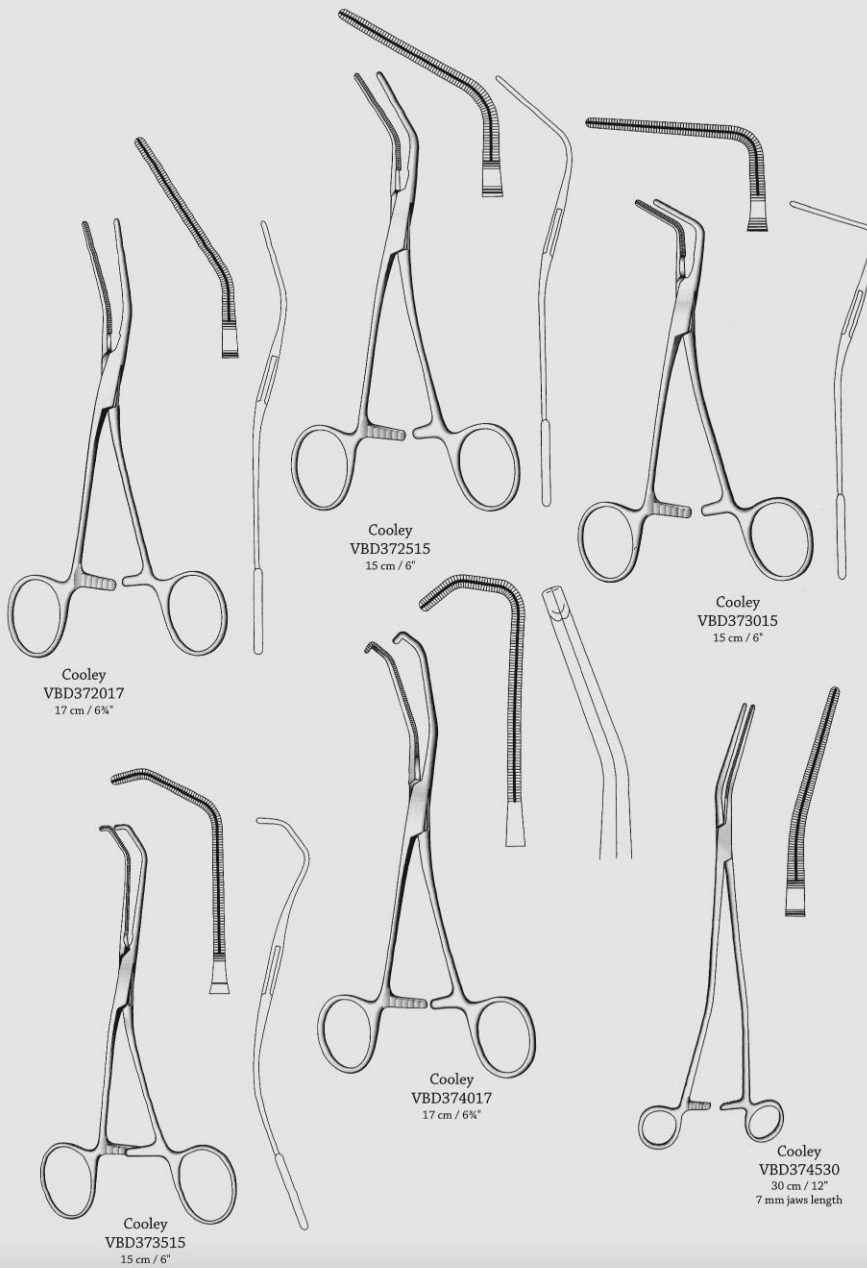
400





Cardiovascular Forceps

Anastomosis Clamps, Multi Purpose Vascular Clamps
Anastomosensklammern, Mehrzweck-Gefäßklammern
Pinzas para anastomosis, Pinzas vasculares de usos multiples



قلب و عروق
پنس ها



CE

SQS Certificate
ISO 9001:2000
ISO 13485:2003

401



Cardiovascular Forceps

Carotid Shunt Clamps, Peripheral Vascular Clamps
Carotis-Shuntklammern, Peripherel-Gefäßklammern
Pinzas para shunt carotídeo, Pinzas para vasos periféricos

قلب و عروق
کلمپ ها



CE

SQS Certificate
ISO 9001:2000
ISO 13485:2003

402



Javid
VBD375018
18 cm / 7"

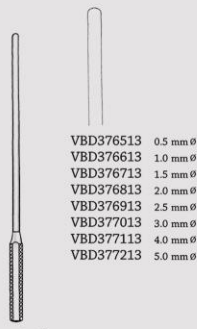
VBD376018
18 cm / 7"
Vascular measuring device

Javid
VBD375519
19 cm / 7½"



Vascular Dilator

Vascular Dilators and Internis Spindel, Vascular Dilators
Gefäßdilatoren und Internispenal, Gefäßdilatoren
Dilatadores vasculares Y Espindles para la internis, Dilatadores vasculares



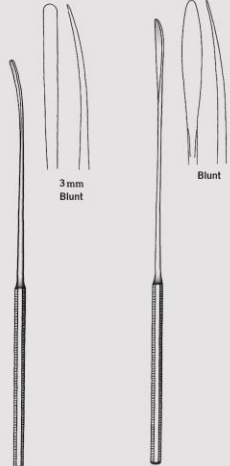
Cooley
13 cm / 5 1/4"
Malleable

- VBD376513 0.5 mm ϕ
- VBD376613 1.0 mm ϕ
- VBD376713 1.5 mm ϕ
- VBD376813 2.0 mm ϕ
- VBD376913 2.5 mm ϕ
- VBD377013 3.0 mm ϕ
- VBD377113 4.0 mm ϕ
- VBD377213 5.0 mm ϕ



De Bakay
Malleable
19 cm / 7 1/2"

- | | | |
|-----------|-----------|---------------|
| VBD377500 | VBD379000 | 0.5 mm ϕ |
| VBD377600 | VBD379100 | 1.0 mm ϕ |
| VBD377700 | VBD379200 | 1.5 mm ϕ |
| VBD377800 | VBD379300 | 2.0 mm ϕ |
| VBD377900 | VBD379400 | 2.5 mm ϕ |
| VBD378000 | VBD379500 | 3.0 mm ϕ |
| VBD378100 | VBD379600 | 3.5 mm ϕ |
| VBD378200 | VBD379700 | 4.0 mm ϕ |
| VBD378300 | VBD379800 | 4.5 mm ϕ |
| VBD378400 | VBD379900 | 5.0 mm ϕ |
| VBD378500 | VBD380100 | 7.0 mm ϕ |
| VBD378600 | VBD380200 | 9.0 mm ϕ |



VBD380518 18.5 cm / 7 1/4"
VBD380521 21.5 cm / 8 1/4"



VBD381014 14 cm / 5 1/2"
VBD381023 23 cm / 9"



Robb
VBD381524
24 cm / 9 1/2"
Fig. 1



Robb
VBD382024
24 cm / 9 1/2"
Fig. 2



Robb
VBD382524
24 cm / 9 1/2"
Fig. 3



Robb
VBD383024
24 cm / 9 1/2"
Fig. 4



SQS Certificate
ISO 9001:2000
ISO 13485:2003





Cardiovascular Forceps
Aortic Dilators
Aorta Dilatatore
Dilatadores aorticos

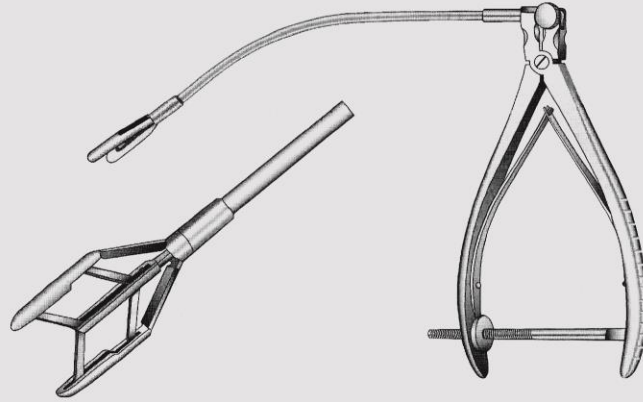
قلب و عروق
آئورت
ديلاتورها



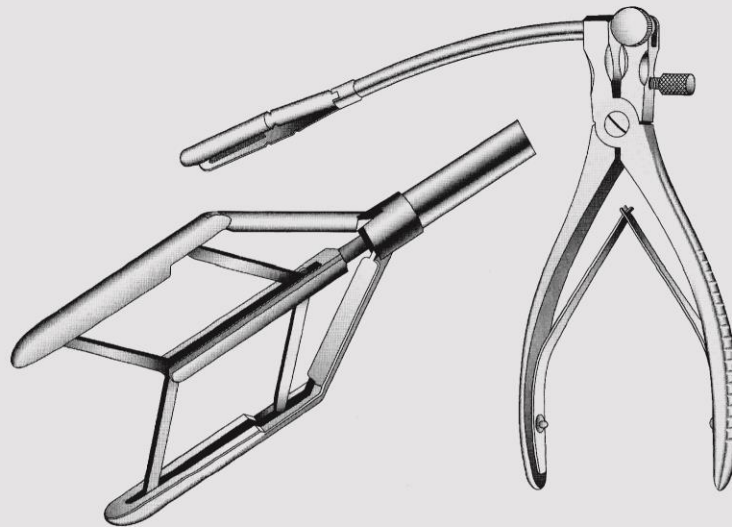
CE

SQS Certificate
ISO 9001:2000
ISO 13485:2003

404

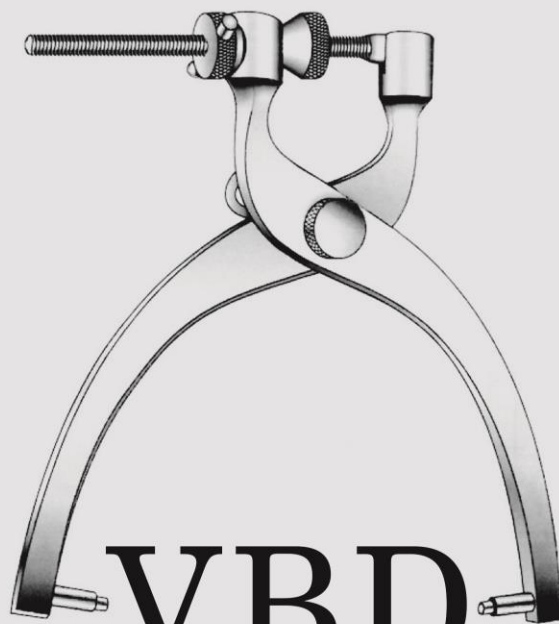


Cooley
VBD383500
Blade opening from 8-15 mm
With thread fixation



Tubbs
VBD384000
Blade opening from 8-42 mm
With fixation screw

DIAMOND SURGICAL
WWW.DIAMONDMED.IR INSTRUMENTS



VBD
Neurosurgery



CE

SQS Certificate
ISO 9001:2000
ISO 13485:2003

405

www.Diamondmed.ir



Neurosurgery

Cranial Rongeurs, Wire Saw
Schadelkangen, Drahtsagen
Pinzas Sacabocados craneales, Sierras de hilo

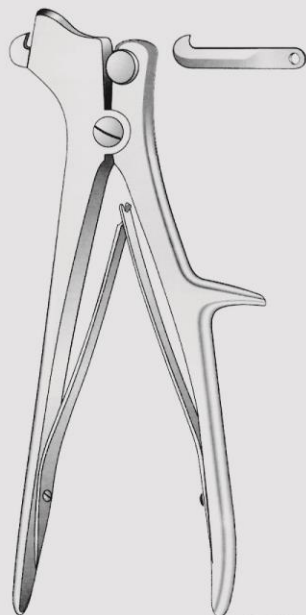
مغز و اعصاب
جمعہ



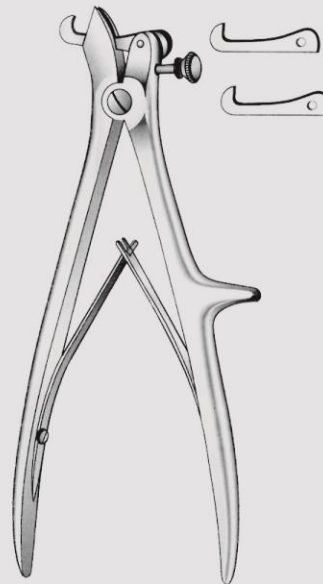
CE

SQS Certificate
ISO 9001:2000
ISO 13485:2003

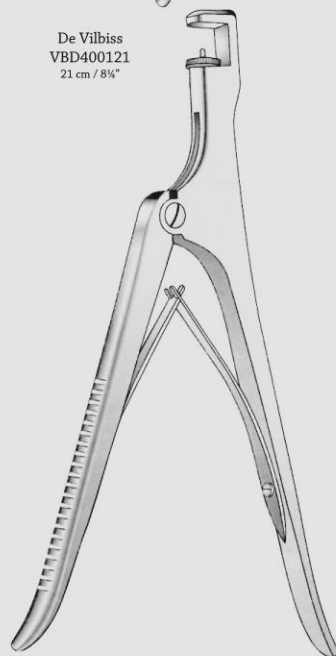
406



De Vilbiss
VBD400121
21 cm / 8 1/4"



Dahlgren
VBD400520
20 cm / 8"



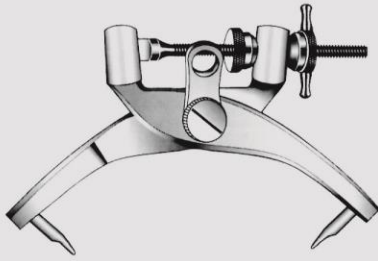
Cone
VBD401022
22.5 cm / 9"
Cranial punch



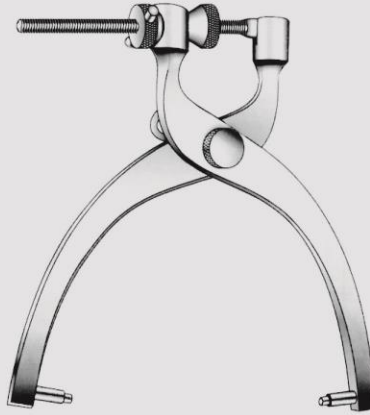
Martel
VBD401533
33 cm / 13"
Saw guide, flexible



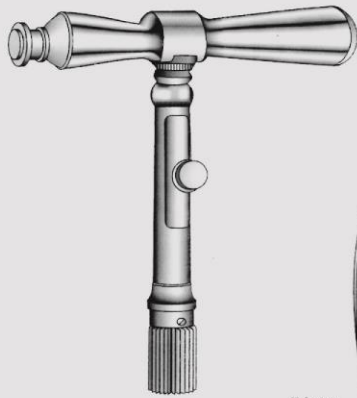
Neurosurgery
Skull Traction Tongs
Schadelhalter
Estribos de traccion craneal



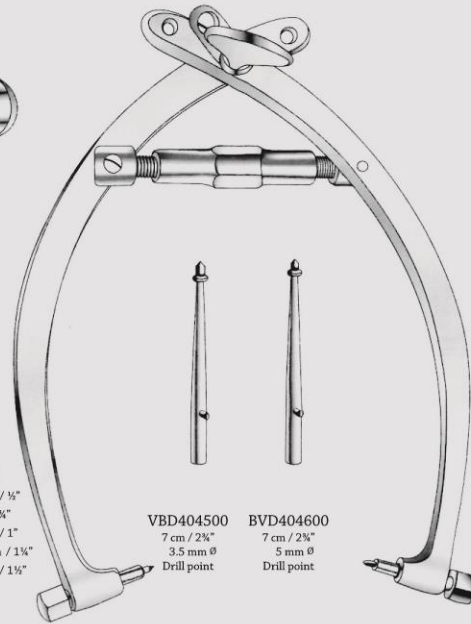
Crutchfield
VBD402000
Small pattern



Crutchfield
VBD402500
Medium pattern



	Hole size	
VBD403012	12.7 mm / 1/2"	
VBD403019	19 mm / 3/4"	
VBD403025	25.4 mm / 1"	
Hudson 10 cm / 4" Trephine	VBD403031	31.75 mm / 1 1/4"
	VBD403038	38.1 mm / 1 1/2"



VBD404500	BVD404600
7 cm / 2 3/4"	7 cm / 2 3/4"
3.5 mm Ø	5 mm Ø
Drill point	Drill point

VBD404000 Small
VBD404100 Large

مغز و اعصاب
کراچفیلد



CE

SQS Certificate
ISO 9001:2000
ISO 13485:2003

407



Neurosurgery
 Clip Applying Forceps
 Clips Anlegezangen
 Grapas pinzas aplicadoras

مغز و اعصاب
 پنس ها

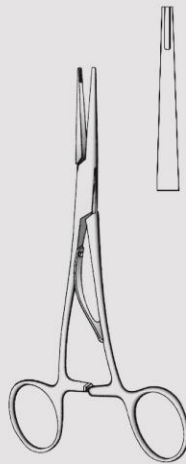
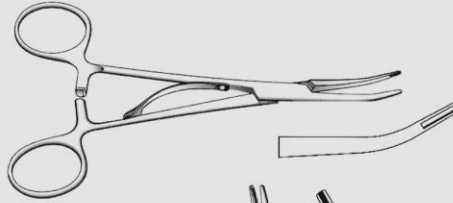


CE

SQS Certificate
 ISO 9001:2000
 ISO 13485:2003

408

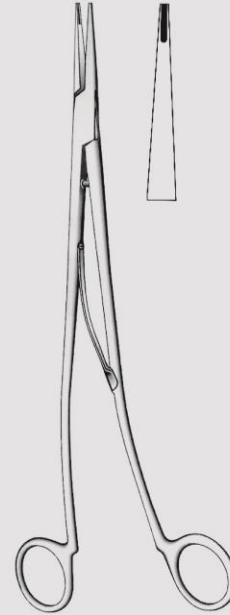
McKenzie
 VBD405015 15 cm / 6"
 VBD405019 19 cm / 7½"



McKenzie
 VBD405515 15 cm / 6"
 VBD405519 19 cm / 7½"



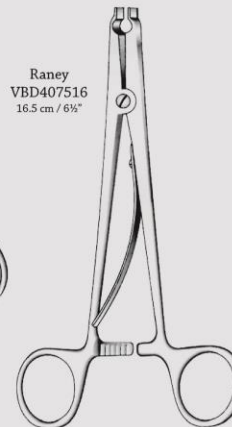
Smithwick
 VBD406023 23 cm / 9"
 VBD406026 26 cm / 10¼"



Sweet
 VBD406523 23 cm / 9"
 VBD406525 25 cm / 10"



Olivecrona Toennis
 VBD407014
 14 cm / 5½"



Raney
 VBD407516
 16.5 cm / 6½"

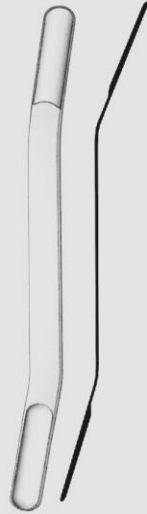


Neurosurgery

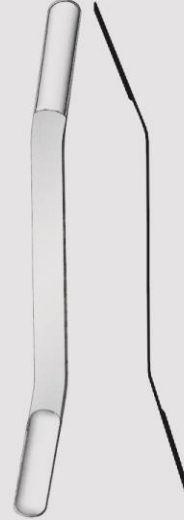
Nerve Root Retractors and Brain Spatula
Nervenzwischenklappen und Hirnspatula
Separadores para la raiz de nervio y Espatulas Cerebrales



Cushing
VBD409517 17 cm / 6 3/4"
VBD409520 20 cm / 8"
VBD409528 28 cm / 11 1/4"



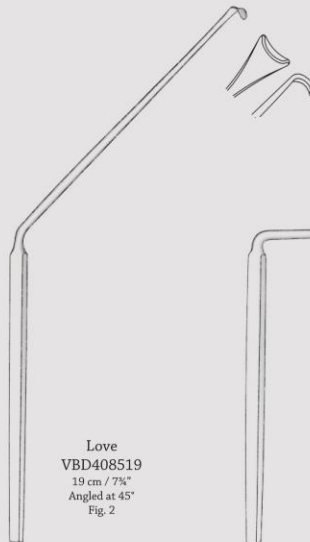
Olivecrona
VBD410118 7 x 9 mm
VBD410218 11 x 13 mm
VBD410318 15 x 18 mm
VBD410418 18 x 22 mm
18 cm / 7"
Concave



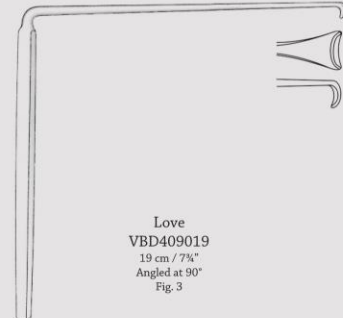
Olivecrona
VBD410518 7 x 9 mm
VBD410618 11 x 13 mm
VBD410718 15 x 18 mm
VBD410818 18 x 22 mm
18 cm / 7"
Convex



Love
VBD408019
19 cm / 7 1/2"
Straight
Fig. 1



Love
VBD408519
19 cm / 7 1/2"
Angled at 45°
Fig. 2



Love
VBD409019
19 cm / 7 1/2"
Angled at 90°
Fig. 3

مغز و اعصاب
اکار تورها



CE

SQS Certificate
ISO 9001:2000
ISO 13485:2003

409



Neurosurgery

Dura Dissectors, Nerve Root Retractors
Dura-Dissektoren, Nervenzweihaken
Disecadores para dura madre, Separadores para la raíz de nervio

مغز و اعصاب
اکارتورها



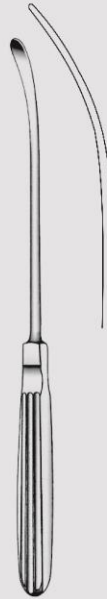
CE

SQS Certificate
ISO 9001:2000
ISO 13485:2003

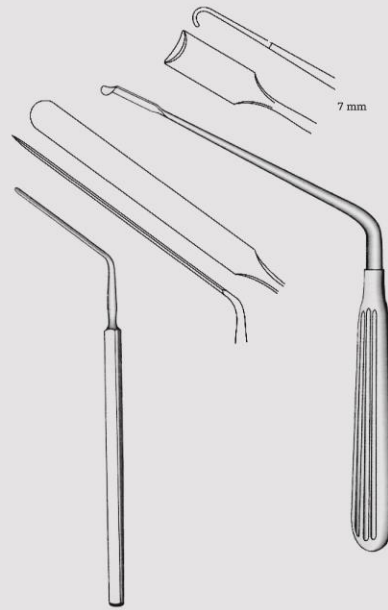
410



Davis
VBD411024
24.5 cm / 9 1/2"

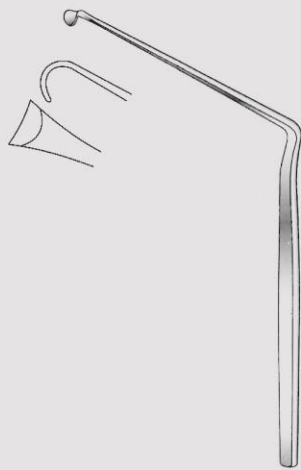


Sachs
VBD411521
21 cm / 8 1/4"

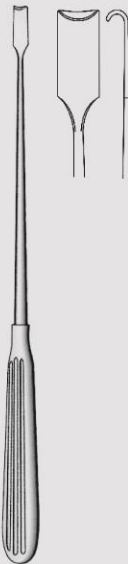


Horsley
VBD412020
20 cm / 8"

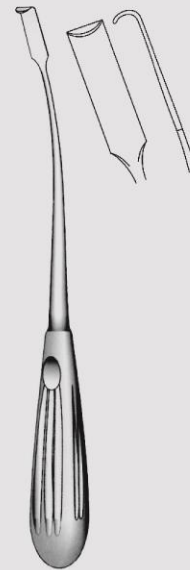
Scoville
VBD412520
20 cm / 8"



VBD413021
21 cm / 8 1/4"



Scoville
VBD413523
23 cm / 9"



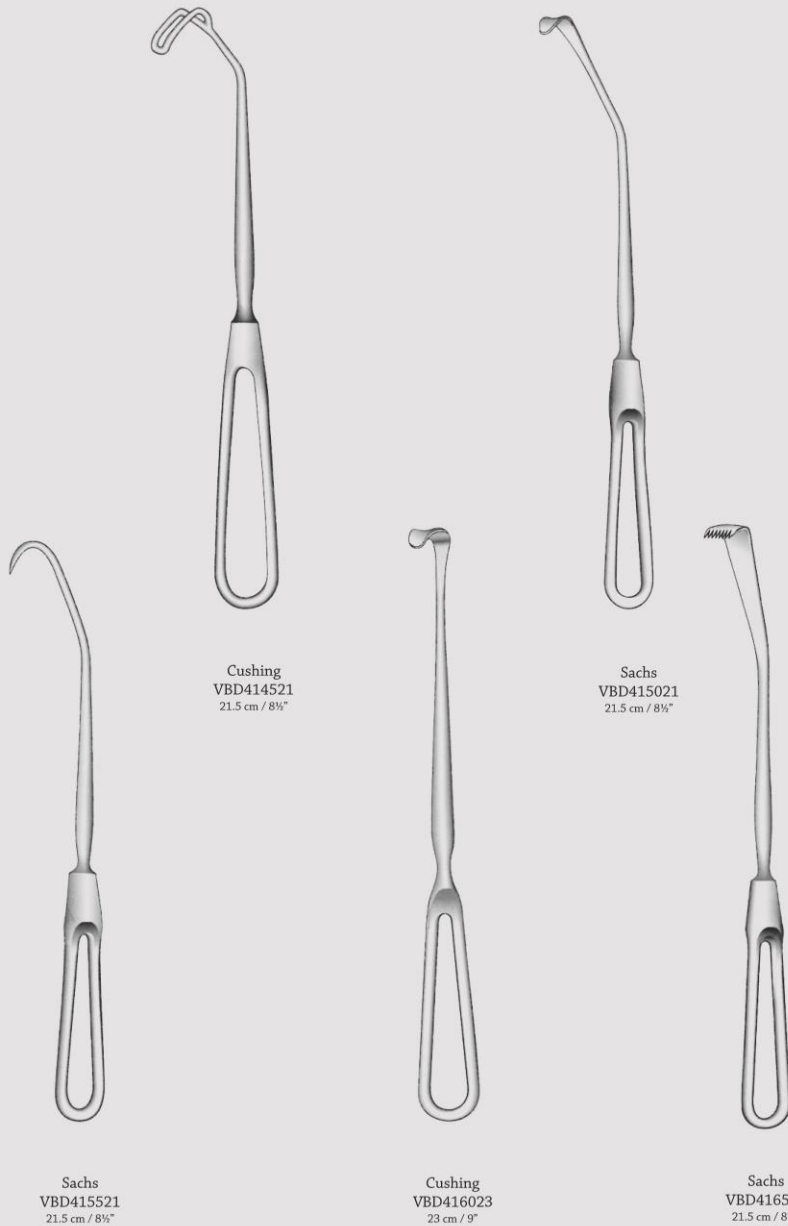
Holsher
VBD414024
24 cm / 9 1/2"



Neurosurgery

Nerve Retractors
Nervwurzelhaken
Separadores para la raiz de nervio

مغز و اعصاب
اکار تورها



CE

SQS Certificate
ISO 9001:2000
ISO 13485:2003

411



Neurosurgery
Nerve Hooks, Dura Hooks and Dissectors
Nervhaken, und Durahaken
Ganchos Para nervios, Ganchos para duramadre

مغز و اعصاب
هوک ها



CE

SQS Certificate
ISO 9001:2000
ISO 13485:2003

412



Dandy
VBD417020
20 cm / 8"



Dandy
VBD417520
20 cm / 8"



Dandy
VBD418020
20 cm / 8"



Cushing

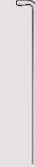


Fig. 1
VBD418519 19 cm / 7 1/2"
VBD418528 28 cm / 11"



Fig. 2
VBD418619
VBD418628



Graham
VBD419016
16.5 cm / 6 1/2"
Blunt



Sachs
VBD419518
18.5 cm / 7 1/4"
Sharp



Cushing
VBD420114
14 cm / 5 1/2"



VBD420513
VBD420518
Sharp



Frazier VBD420613
13 cm / 5" Blunt
VBD420618
18 cm / 7"



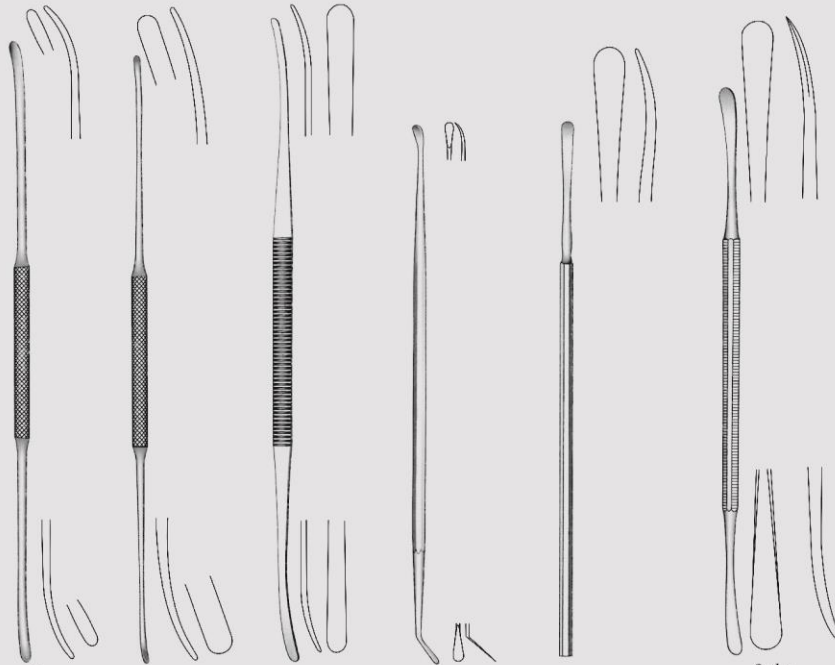
Smithwick
VBD421029
29 cm / 11 1/2"



Adson
VBD421520
20 cm / 8"
Sharp blade 5 mm at right angle



Neurosurgery
Dura Dissectors
Dura-Dissektoren
Disecadores para dura-madre



Olivecrona
VBD422019
VBD422024

19.5 cm / 7 1/2"
24 cm / 9 1/2"

Olivecrona
VBD422518
VBD422524

18 cm / 7"
24 cm / 9 1/2"

Toennis
VBD423025

25 cm / 10"

Milligan
VBD423521

21 cm / 8 1/4"

VBD424022

22 cm / 8 3/4"

Sachs
VBD424521

21 cm / 8 1/4"

مغز و اعصاب
دایسکتورها



CE

SQS Certificate
ISO 9001:2000
ISO 13485:2003

413



Neurosurgery
Dura Dissectors
Dura-Dissektoren
Disecadores para dura-madre

مغز و اعصاب
سرساگشن ها



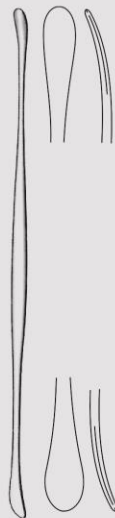
CE

SQS Certificate
ISO 9001:2000
ISO 13485:2003

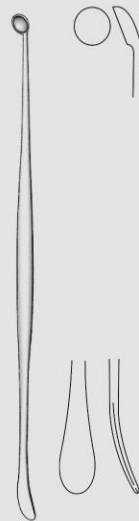
414



Sachs
VBD425021
21 cm / 8 1/4"



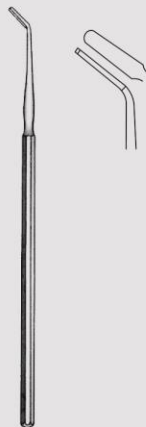
Penfield
VBD425529
29 cm / 11 1/4"



Penfield
VBD426017
17.5 cm / 7"



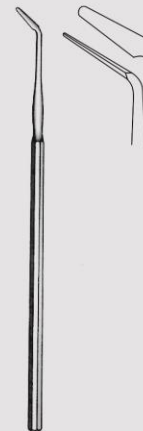
Penfield
VBD426521
21.5 cm / 8 1/2"



Hoen
VBD427015
15 cm / 6"



Hoen
VBD427515
15 cm / 6"



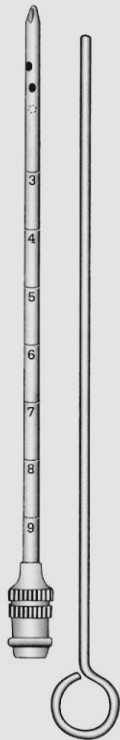
Frazier
VBD428015
15 cm / 6"



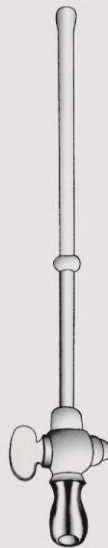
NeuroSurgery

Empirgung Cannula, Suction tubes and Tampones Cannula
Pneumostomakanülen, Saugkanülen und Tamponenöhre
Cánulas Ventriculares, Tubos de aspiración y Cánula Pitagoras

مغز و اعصاب
دایسکتورها



Frazier
VBD428512
3 mm Ø
Silver plated
VBD428612
2 mm Ø
Gold plated
12 cm / 4 3/4"



Seiffert
VBD429012
12.5 cm / 5"



Elsberg
VBD429511
11 cm / 4 3/8"
7 Fr. 2.3 mm, luer lock sterling.
3 hole closed end



CE

SQS Certificate
ISO 9001:2000
ISO 13485:2003

415



NeuroSurgery
Lamina Spreaders
Wirbelkörperspreizer
Separadores para cuerpos vertebrales

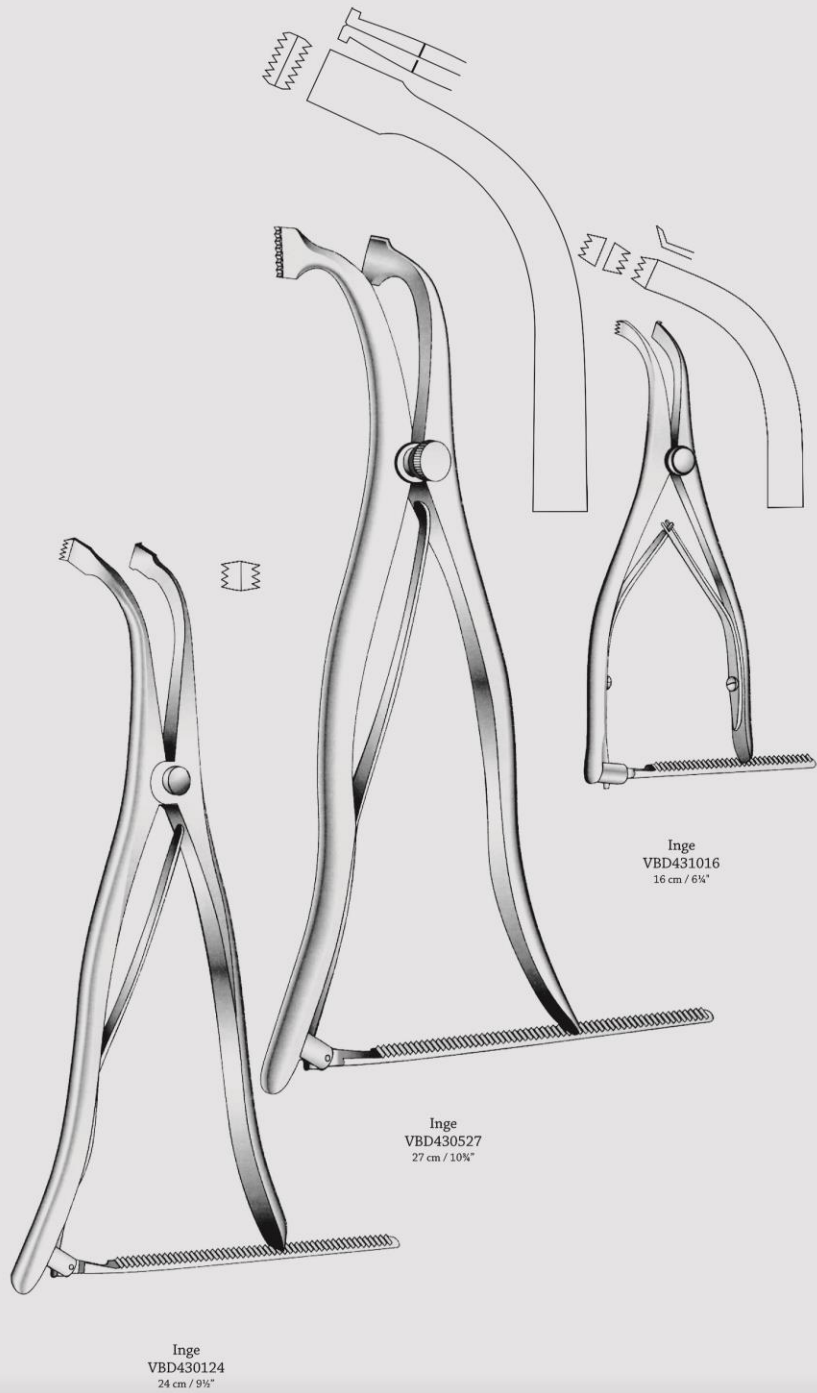
مغز و اعصاب
اسپرایدرها



CE

SQS Certificate
ISO 9001:2000
ISO 13485:2003

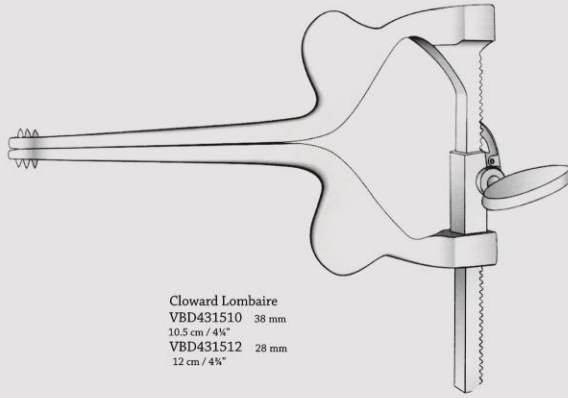
416



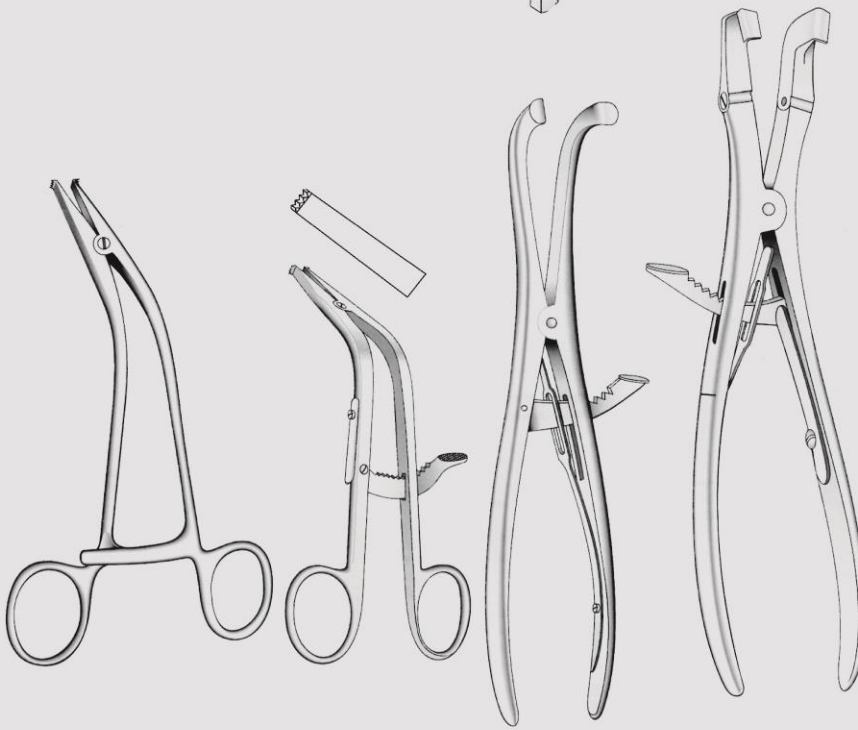


NeuroSurgery

Lamina Spreaders, Wound Spreaders
Wirbelkorpspreizer, Wundspreizer
Separadores para cuerpos vertebrales, Separadores autoestaticos



Cloward Lombaire
VBD431510 38 mm
10.5 cm / 4 1/4"
VBD431512 28 mm
12 cm / 4 3/4"



Cloward
VBD432016 16 cm / 6 1/4"
VBD432020 20 cm / 8"

Cloward
VBD432516
16 cm / 6 1/4"

Mathey
VBD433018
18 cm / 7"

Maurer
VBD433520
20 cm / 8"

مغز و اعصاب
اسپرایدرها



CE

SQS Certificate
ISO 9001:2000
ISO 13485:2003

417



NeuroSurgery
Intervertebral Disc Rongeurs
Bandscheibenstanzen
Pinzas cortantes para discos intervertebrales

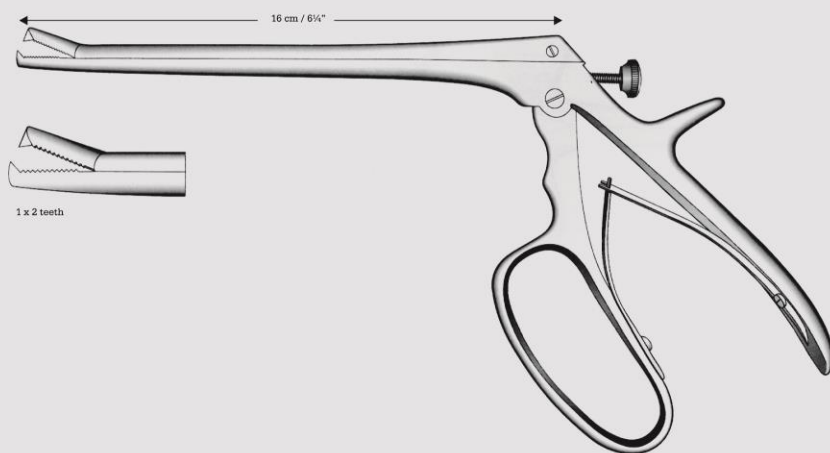
مغز و اعصاب
کریستون پانچ ها



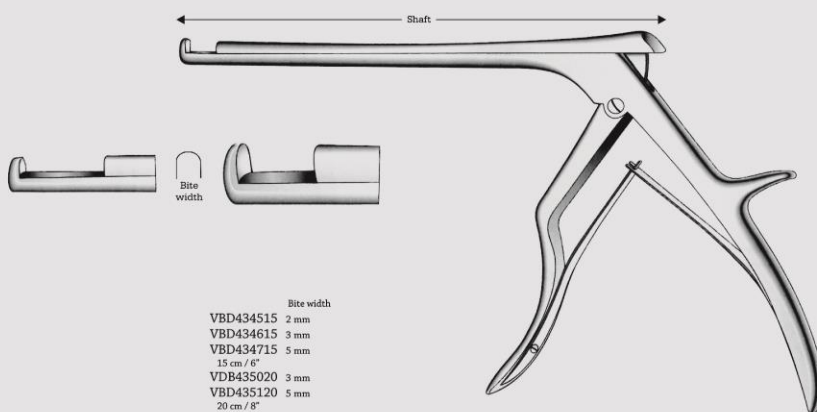
CE

SQS Certificate
ISO 9001:2000
ISO 13485:2003

418



VBD434000
Grasping forceps



Colclough
Large handle

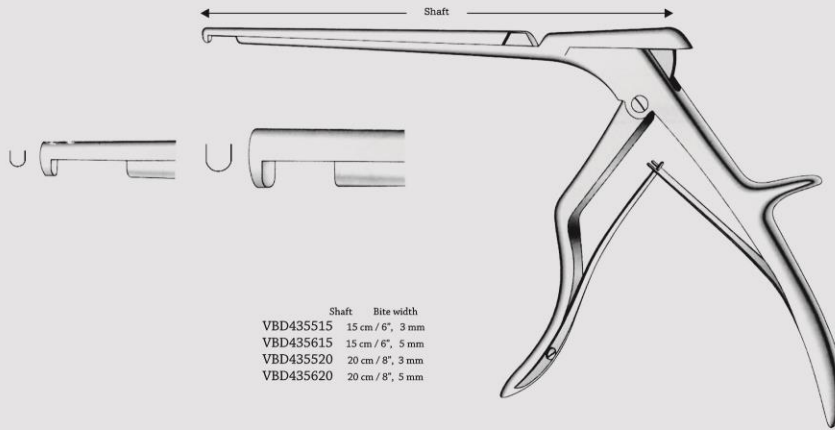
Bite width

VBD434515	2 mm
VBD434615	3 mm
VBD434715	5 mm
15 cm / 6"	
VBD435020	3 mm
VBD435120	5 mm
20 cm / 8"	

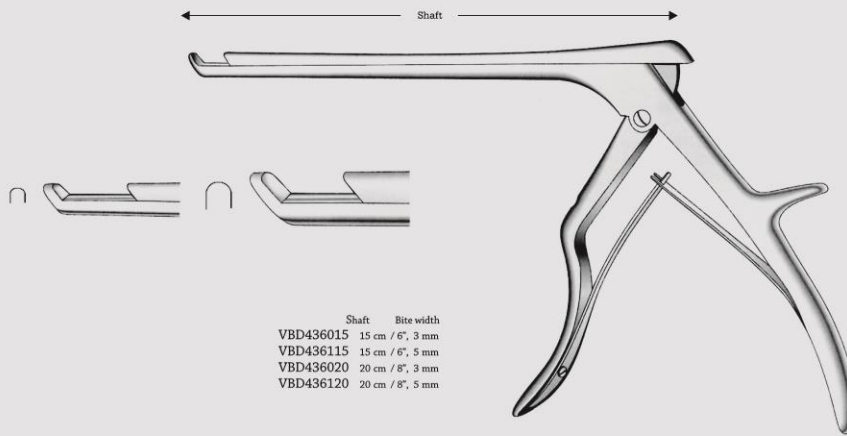


NeuroSurgery

Intervertebral Disc Rongeurs
Bandscheibenstanzen
Pinzas cortantes para discos intervertebrales



Colclough
Large handle



Colclough Richter
Large handle

مغز و اعصاب
کریستون پانچ ها



CE

SQS Certificate
ISO 9001:2000
ISO 13485:2003

419



Neurosurgery

Intervertebral Disc Rongeurs
Bandscheibenstanzen
Pinzas cortantes para discos intervertebrales

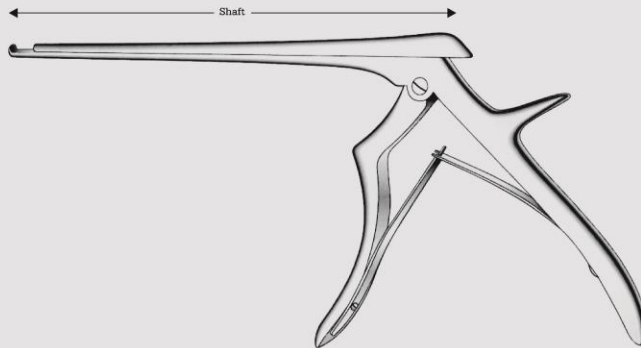
مغز و اعصاب
کریستون پانچ ها

ایزاجراحی
دایموند

CE

SQS Certificate
ISO 9001:2000
ISO 13485:2003

420



Ferris-Smith-Kerrison

Upward cutting

	VBD436515	15 cm
	VBD436518	18 cm
	VBD436520	20 cm
	1 mm	
	VBD436615	15 cm
	VBD436618	18 cm
	VBD436620	20 cm
	2 mm	
	VBD436715	15 cm
	VBD436718	18 cm
	VBD436720	20 cm
	3 mm	
	VBD436815	15 cm
	VBD436818	18 cm
	VBD436820	20 cm
	4 mm	
	VBD436915	15 cm
	VBD436918	18 cm
	VBD436920	20 cm
	5 mm	
	VBD437015	15 cm
	VBD437018	18 cm
	VBD437020	20 cm
	6 mm	

Downward cutting

	VBD437515	15 cm
	VBD437518	18 cm
	VBD437520	20 cm
	1 mm	
	VBD437615	15 cm
	VBD437618	18 cm
	VBD437620	20 cm
	2 mm	
	VBD437715	15 cm
	VBD437718	18 cm
	VBD437720	20 cm
	3 mm	
	VBD437815	15 cm
	VBD437818	18 cm
	VBD437820	20 cm
	4 mm	
	VBD437915	15 cm
	VBD437918	18 cm
	VBD437920	20 cm
	5 mm	
	VBD438015	15 cm
	VBD438018	18 cm
	VBD438020	20 cm
	6 mm	

Forward cutting

	VBD438715	15 c
	VBD438718	18 c
	VBD438720	20 c
	3 mm	
	VBD438615	15 cm
	VBD438618	18 cm
	VBD438620	20 cm
	2 mm	
	VBD438515	15 cm
	VBD438518	18 cm
	VBD438520	20 cm
	1 mm	

Forward cutting

	VBD438815	15 cm
	VBD438818	18 cm
	VBD438820	20 cm
	4 mm	
	VBD438915	15 cm
	VBD438918	18 cm
	VBD438920	20 cm
	5 mm	
	VBD439015	15 cm
	VBD439018	18 cm
	VBD439020	20 cm
	6 mm	





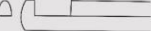

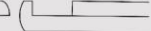
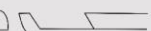


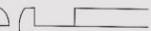
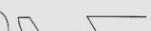


Neurosurgery

Intervertebral Disc Rongeurs
Bandscheibenstanzen
Pinzas cortantes para discos intervertebrales



مغز و اعصاب
بیتیتوری ها

Upward cutting		Forward cutting	
	VBD439515 15 cm VBD439518 18 cm VBD439520 20 cm 1 mm		VBD440515 15 cm VBD440518 18 cm VBD440520 20 cm 1 mm
	VBD439615 15 cm VBD439618 18 cm VBD439620 20 cm 2 mm		VBD440615 15 cm VBD440618 18 cm VBD440620 20 cm 2 mm
	VBD439715 15 cm VBD439718 18 cm VBD439720 20 cm 3 mm		VBD440715 15 cm VBD440718 18 cm VBD440720 20 cm 3 mm
	VBD439815 15 cm VBD439818 18 cm VBD439820 20 cm 4 mm		VBD440815 15 cm VBD440818 18 cm VBD440820 20 cm 4 mm
	VBD439915 15 cm VBD439918 18 cm VBD439920 20 cm 5 mm		VBD440915 15 cm VBD440918 18 cm VBD440920 20 cm 5 mm
	VBD440115 15 cm VBD440118 18 cm VBD440120 20 cm 6 mm		VBD441015 15 cm VBD441018 18 cm VBD441020 20 cm 6 mm



CE

SQS Certificate
ISO 9001:2000
ISO 13485:2003

421



Neurosurgery

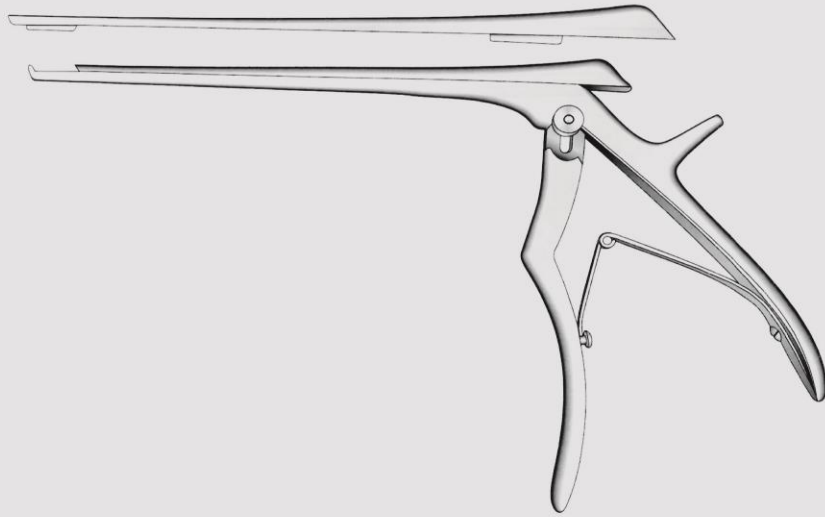
Intervertebral Disc Rongeurs
Bandscheibenstanzen
Pinzas cortantes para discos intervertebrales

مغز و اعصاب
کریستون پانچ ها



SQS Certificate
ISO 9001:2000
ISO 13485:2003

422



Upward cutting

	VBD441515	15 cm
	VBD441518	18 cm
	VBD441520	20 cm
	1 mm	
	VBD441615	15 cm
	VBD441618	18 cm
	VBD441620	20 cm
	2 mm	
	VBD441715	15 cm
	VBD441718	18 cm
	VBD441720	20 cm
	3 mm	
	VBD441815	15 cm
	VBD441818	18 cm
	VBD441820	20 cm
	4 mm	
	VBD441915	15 cm
	VBD441918	18 cm
	VBD441920	20 cm
	5 mm	
	VBD442015	15 cm
	VBD442018	18 cm
	VBD442020	20 cm
	6 mm	

Forward cutting

	VBD443515	15 cm
	VBD443518	18 cm
	VBD443520	20 cm
	1 mm	
	VBD443615	15 cm
	VBD443618	18 cm
	VBD443620	20 cm
	2 mm	
	VBD443715	15 cm
	VBD443718	18 cm
	VBD443720	20 cm
	3 mm	

Downward cutting

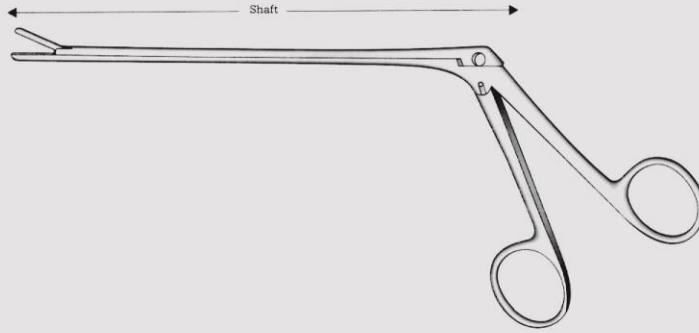
	VBD442515	15 cm
	VBD442518	18 cm
	VBD442520	20 cm
	1 mm	
	VBD442615	15 cm
	VBD442618	18 cm
	VBD442620	20 cm
	2 mm	
	VBD442715	15 cm
	VBD442718	18 cm
	VBD442720	20 cm
	3 mm	
	VBD442815	15 cm
	VBD442818	18 cm
	VBD442820	20 cm
	4 mm	
	VBD442915	15 cm
	VBD442918	18 cm
	VBD442920	20 cm
	5 mm	
	VBD443015	15 cm
	VBD443018	18 cm
	VBD443020	20 cm
	6 mm	

Forward cutting

	VBD443815	15 cm
	VBD443818	18 cm
	VBD443820	20 cm
	4 mm	
	VBD443915	15 cm
	VBD443918	18 cm
	VBD443920	20 cm
	5 mm	
	VBD444015	15 cm
	VBD444018	18 cm
	VBD444020	20 cm
	6 mm	

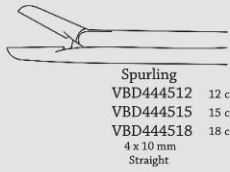


Neurosurgery
Laminectomy Rongeurs
Laminektomie-Zangen
Pinzas cortantes para laminectomia

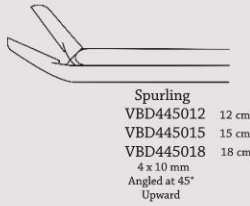


مغز و اعصاب
بیتیتوری ها

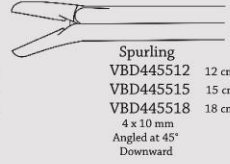
4 mm



Spurling
VBD444512 12 cm
VBD444515 15 cm
VBD444518 18 cm
4 x 10 mm
Straight

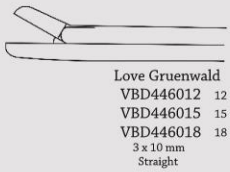


Spurling
VBD445012 12 cm
VBD445015 15 cm
VBD445018 18 cm
4 x 10 mm
Angled at 45°
Upward

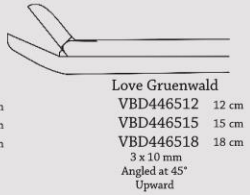


Spurling
VBD445512 12 cm
VBD445515 15 cm
VBD445518 18 cm
4 x 10 mm
Angled at 45°
Downward

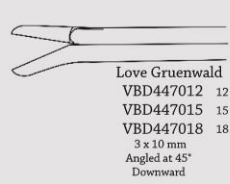
3 mm



Love Gruenwald
VBD446012 12 cm
VBD446015 15 cm
VBD446018 18 cm
3 x 10 mm
Straight

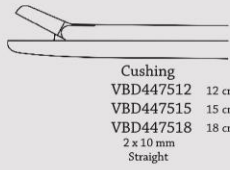


Love Gruenwald
VBD446512 12 cm
VBD446515 15 cm
VBD446518 18 cm
3 x 10 mm
Angled at 45°
Upward

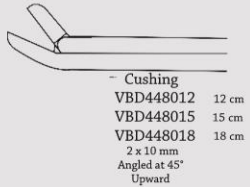


Love Gruenwald
VBD447012 12 cm
VBD447015 15 cm
VBD447018 18 cm
3 x 10 mm
Angled at 45°
Downward

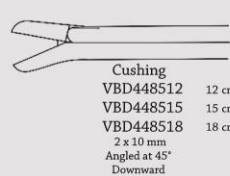
2 mm



Cushing
VBD447512 12 cm
VBD447515 15 cm
VBD447518 18 cm
2 x 10 mm
Straight



Cushing
VBD448012 12 cm
VBD448015 15 cm
VBD448018 18 cm
2 x 10 mm
Angled at 45°
Upward



Cushing
VBD448512 12 cm
VBD448515 15 cm
VBD448518 18 cm
2 x 10 mm
Angled at 45°
Downward



CE

SQS Certificate
ISO 9001:2000
ISO 13485:2003

423



Neurosurgery
Laminectomy Rongeurs
Laminektomie-Zangen
Pinzas cortantes para laminectomia

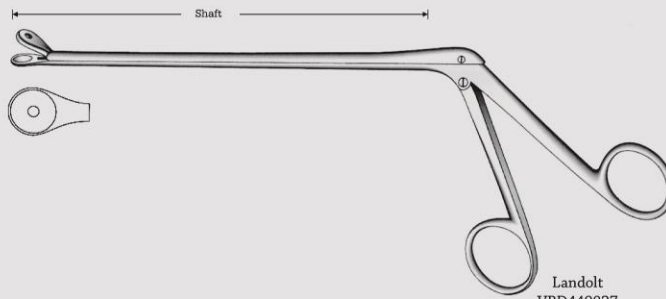
مغز و اعصاب
پتنوری ها



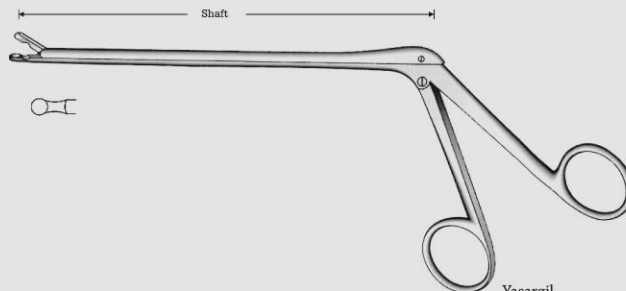
CE

SQS Certificate
ISO 9001:2000
ISO 13485:2003

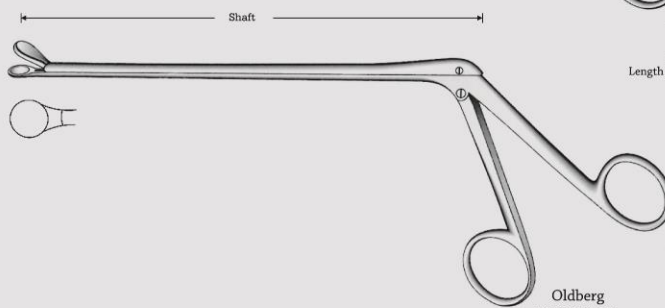
424



Landolt
VBD449027
27 cm / 10 1/2"
Tumor grasping forceps
Length of shaft: 20 cm / 8", blunt

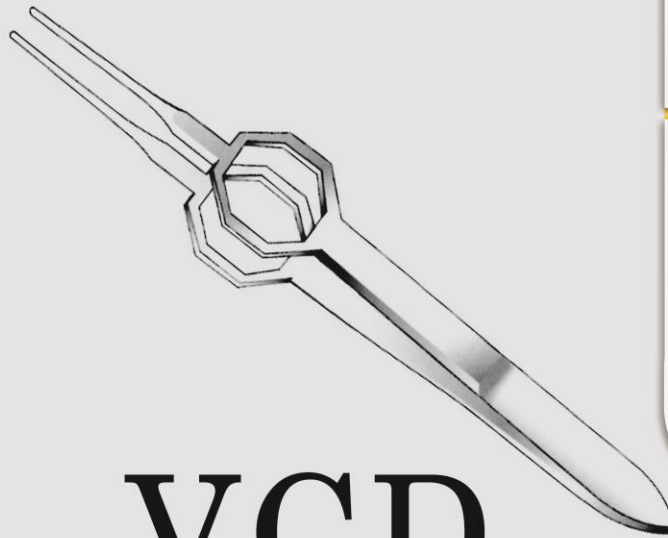


Yasargil
VBD449525
25 cm / 10"
Pituitary rongeur
Length of shaft: 18 cm / 7", sharp



Oldberg
VBD450125
25 cm / 10"
Length of shaft: 18 cm / 7"

DIAMOND SURGICAL
WWW.DIAMONDMED.IR INSTRUMENTS



VCD
VCE

Ophthalmology



CE

SQS Certificate
ISO 9001:2000
ISO 13485:2003

425

www.Diamondmed.ir



Ophthalmology
Eye Speculas
Sperrelevatoren
Blefarostatos

چشمی
بلفارست ها



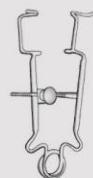
SQS Certificate
ISO 9001:2000
ISO 13485:2003



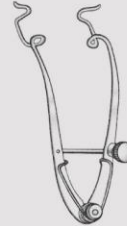
Bowman
VCD300107
7 cm / 2 3/4"



Smith
VCD300505
5 cm / 2"



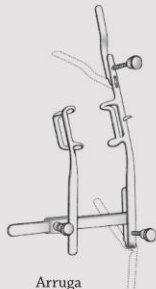
Critchett
VCD301007
7 cm / 2 3/4"



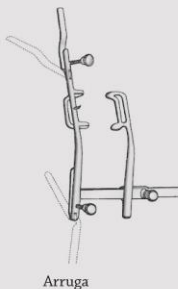
Knapp-Clark
VCD301508
8 cm / 3 1/4"



Graefe
VCD302007
7 cm / 2 3/4"
VCD302009
9 cm / 3 3/4"



Arruga
VCD302507
7 cm / 2 3/4"



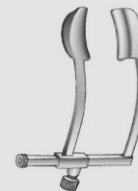
Arruga
VCD303007
7 cm / 2 3/4"



Pley
VCD303506
6 cm / 2 1/4"



Weiss
VCD304008
8 cm / 3 1/4"



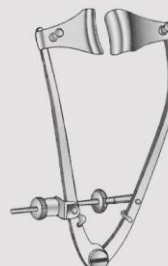
Cook
VCD304504
4 cm / 1 1/2"
VCD304505
5 cm / 2"



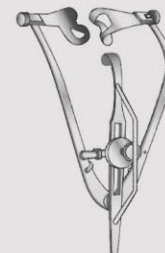
Lister-Burch
VCD305008
8 cm / 3 1/4"



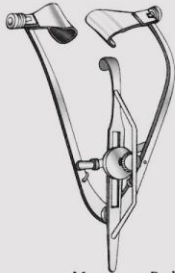
Mueller
CD305507
7 cm / 2 3/4"



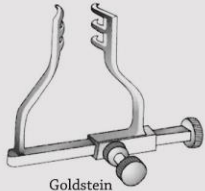
McPherson
VCD306008
8.5 cm / 3 3/4"
Blades 13 mm wide,
with suture posts



Guyton Park
VCD306509
9 cm / 3 3/4"
Solid blades 14 mm wide,
with suture posts



Maumenee-Park
VCD307008
8.5 cm / 3 3/4"
Solid blades 14 mm wide,
with lock screws



Goldstein
VCD307503
3 cm / 1 1/8"
3 x 3.5 mm pointed prongs
Lacrimal sac retractor



Castroviejo
VCD308009
9.5 cm / 3 3/4"
15 x 5 mm outer diameter
Medium size blades



Stevenson
VCD308507
7 cm / 2 3/4"



Desmarres
13 cm / 5"



VCD309013
12 mm



VCD309113
14 mm



VCD309213
16 mm



VCD309313
18 mm



Desmarres
13 cm / 5"



VCD309513
12 mm



VCD309613
14 mm



VCD309713
16 mm



VCD309813
18 mm



Jaeger
VCD310111
11 cm / 4 3/8"



Ophthalmology

Eye Speculas and Lid Instruments
Sperrehelevatoren und Lidinstrumente
Blefarostatos y Instrumentos para parpados

چشمی
بلغارست ها
بلک برگردان



CE

SQS Certificate
ISO 9001:2000
ISO 13485:2003

427



Ophthalmology

Lacrimal Dilators and Probes
Tränenkanal Dilatatore und Sonden
Dilatadores y Estiletos para canal Lacrimal

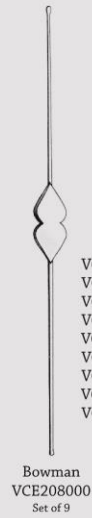
چشمی
پروپ ها



CE

SQS Certificate
ISO 9001:2000
ISO 13485:2003

428



Bowman
VCE208000
Set of 9

	Fig
VCE032100	0/0
VCE032111	1/1
VCE032122	2/2
VCE032133	3/3
VCE032144	4/4
VCE032155	5/5
VCE032166	6/6
VCE032177	7/7
VCE032188	8/8

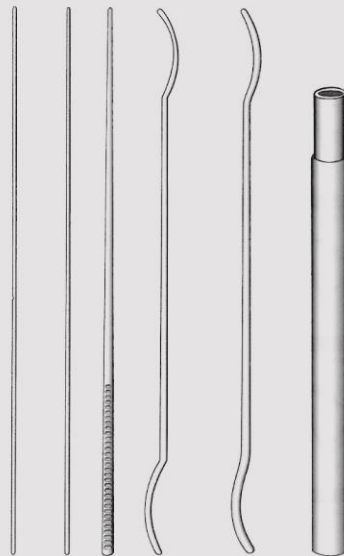


Bowman
VCE208500
Set of 9

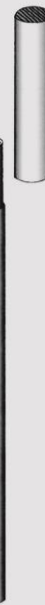
	Fig	
VCE032500	00/0	VCE032700
VCE032501	0/1	VCE032701
VCE032512	1/2	VCE032712
VCE032523	2/3	VCE032723
VCE032534	3/4	VCE032734
VCE032545	4/5	VCE032745
VCE032556	5/6	VCE032756
VCE032567	6/7	VCE032767
VCE032578	7/8	VCE032778



Bowman
VCE209000
Set of 9



Bowman
VCE300100



Wilder
VCE300500
Fig. 1



Wilder
VCE301000
Fig. 2



Wilder
VCE301500
Fig. 3



Castroviejo
VE302014
14 cm / 5 1/2"
One end needle point,
other end medium



Ophthalmology

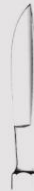
Eye Scalpels, Cataract Knives
Augenskalpelle, Starmesser
Bisturías Para ojos, Cuchillos para catarata



VCD310500



VCD310600



VCD310700



VCD310800



VCD310900



VCD311000



VCD311100



VCD311200



VCD311300



VCD311400



VCD311500



VCD311600



VCD312000



VCD312100



VCD312200



VCD312300



Graefe



VCD313000



VCD313100



VCD313200



VCD312400



VCD312500



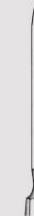
VCD312600



VCD313300



VCD313400



VCD313500

چشمی
چاقوها



CE

SQS Certificate
ISO 9001:2000
ISO 13485:2003

429



Ophthalmology

Keratomes, Cataract Knives
Lanzenmesser (Keratome) Starmesser
Cuchillos lanceolares, Cuchillos para catarata

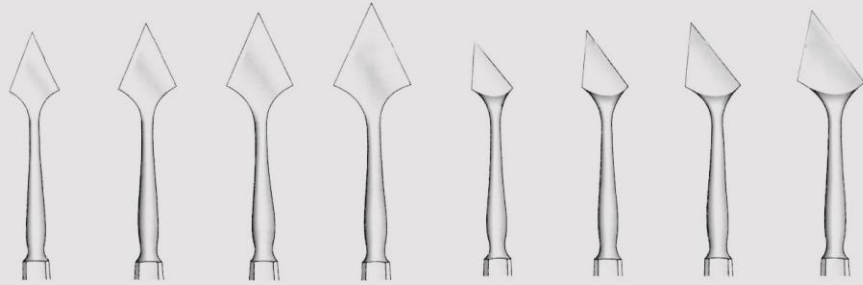
چشمی
چاقوها



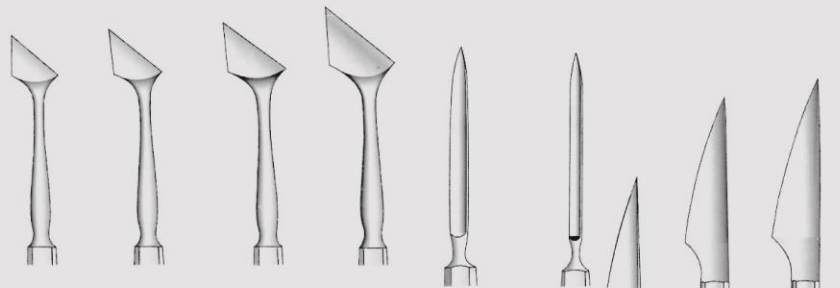
CE

SQS Certificate
ISO 9001:2000
ISO 13485:2003

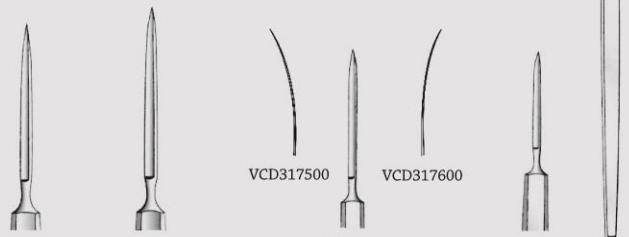
430



Jaeger VCD314000 VCD314100 VCD314200 VCD314300 VCD314500 VCD314600 VCD314700 VCD314800



Jaeger VCD315000 VCD315100 VCD315200 VCD315300 Graefe VCD315500 Deuschmann VCD316000 VCD318500 Fig. 1 VCD318600 Fig. 2



Smith-Green VCD316500 Smith-Green VCD317000 VCD317500 VCD317600 Berens Wheeler VCD318000 Beer



Ophthalmology

Eye Knives, Cataract Needles, Spud and Gouges
Augenmesser, Starznadeln, Hohlmeißel
Cuchillo para ojo, Agujas para catarata, Cincil y Gubia



Knapp
VCD319000

Knapp
VCD319500

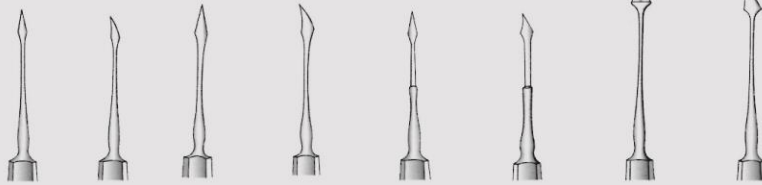
Knapp
VCD320100



Ziegler
VCD320500

Ziegler
VCD321000

Ziegler
VCD321500



VCD322000

VCD322500

VCD323000

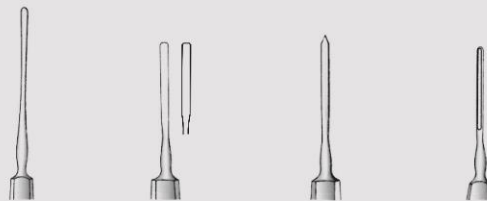
VCD323500

Bowman
VCD324000

Bowman
VCD324500

Desmarres
VCD325000

Desmarres
VCD325500



Dix
VCD326000

Nicati
VCD326500

Walton
VCD327000
Pointed tip

Walton
VCD327500

چشمی
چاقوها



CE

SQS Certificate
ISO 9001:2000
ISO 13485:2003

431



Ophthalmology

Cystotomes, Iris Hooks and Retractors
Cystotome, Irishakchen und Hakchen
Quisotomos, Ganchos Para Iris y Separadores

چشمی
هوک ها



CE

SQS Certificate
ISO 9001:2000
ISO 13485:2003

432



Graefe
VCD328000



Graefe
VCD328500



Graefe
VCD329000



Graefe
VCD329500
Sharp



Graefe
VCD329600
Blunt



Guthrie
VCD330100
1.5 mm inside
VCD330200
2 mm inside



Guthrie
VCD330500
3 mm inside



Knapp
VCD331000
Blunt



Rollet
VCD331500
Hook for lacrimal sac



Ophthalmology

Less Scoop, Emulsation Scoop, Protector and Chisel
Schlingen, Emulsationsöffel, Wundhaken und Messel
Asa Española Para emulsacion Protector y Cincil



Elsching
VCD332000



Elsching
VCD332500



Weber
VCD333000



Weber
VCD333500



Snellen
VCD334000



Graefe
VCD334500



Graefe
VCD335000



Daviel
VCD335500



Daviel
VCD336000



Wells
VCD336500



Arruga
VCD337000



Rollet
VCD337500

چشمی
لنز لوپ
کورت ها



CE

SQS Certificate
ISO 9001:2000
ISO 13485:2003

433



Ophthalmology

Strabismus and Extraction Hooks
Schielhaken und Extraktionshaken
Ganchos p/estrabismo y p/extraccion

چشمی
کورت ها



CE

SQS Certificate
ISO 9001:2000
ISO 13485:2003

434



Graefe
VCD338000
Small



Graefe
VCD338514
14 cm / 5 1/2"
Medium



Graefe
VCD339000
Large



Jaeger
VCD339500



Jaeger
VCD340100



Jameson
VCD340512
12.5 cm / 5"



Arruga
VCD341000
Left



Arruga
VCD341500
Right



Ophthalmology

Iris Spatula, Cyclodialysis Spatulas
Irispatel, Zyktodialyses Spatel
Espatula Para Iris Espatula para ciclodialisis



Weber
VCD342000



Wacker
VCD342500



Wacker
VCD343000



Culler
VCD343500
10 mm



Suker
VCD344000
15 mm



Castroviejo
VCD344500
10 mm



Castroviejo
VCD345000
15 mm

چشمی
اسپاچولاها



CE

SQS Certificate
ISO 9001:2000
ISO 13485:2003

435



Ophthalmology
Chalazion Curettes
Chalazionloffel
Cucharillas para Chalazion

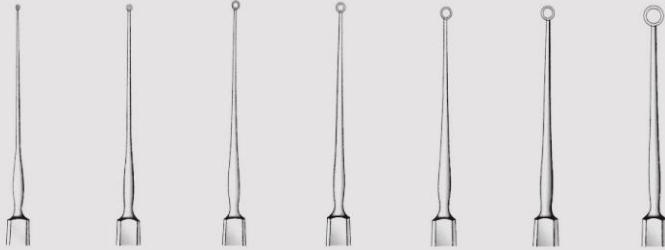
چشمی
کورت ها



CE

SQS Certificate
ISO 9001:2000
ISO 13485:2003

436



Meyhoefer
VCD345500
0.5 mm \emptyset

Meyhoefer
VCD345600
1.0 mm \emptyset

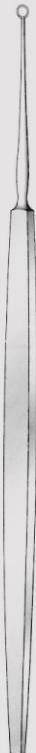
Meyhoefer
VCD345700
1.5 mm \emptyset

Meyhoefer
VCD345800
1.8 mm \emptyset

Meyhoefer
VCD345900
2.0 mm \emptyset

Meyhoefer
VCD346000
2.5 mm \emptyset

Meyhoefer
VCD346100
3.5 mm \emptyset



Meyhoefer
VCD346200
4.0 mm \emptyset



Meyhoefer
VCD346300
4.5 mm \emptyset



Bunge
VCD347000



Bunge
VCD347100



Bunge
VCD347200



Bunge
VCD347300



Bunge
VCD347400



Ophthalmology

Chalazion and Lacrimal Sac Curettes
Chalazionöffner und Tränenkissen-Öffner
Cucharillas p/chalazion y cortantes p/estenosis lacrimal



Heath



VCE302500



VCE302600



VCE302700



VCE302800



Axenfeld
VCE303000
Downward curved



Axenfeld
VCE303500
Upward curved



Axenfeld
VCE304000
Double, sharp



Lang
VCE304500

چشمی
کورت ها



CE

SQS Certificate
ISO 9001:2000
ISO 13485:2003

437



Ophthalmology

Cannulas, Marker, Trephine & Corneoscleral Punch
Kanülen, Zirkel, Trephinen und Kapselstanzen
Cannulas Campos, Trepanos y Pinza saca-bocado

چشمی



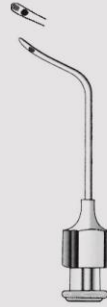
CE

SQS Certificate
ISO 9001:2000
ISO 13485:2003

438



Castroviejo
VCE305000
1.0 mm



Castroviejo
VCE305500
1.5 mm



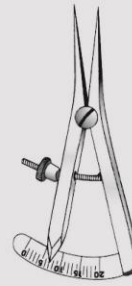
Randolph
VCE306000



Record Cone
VCE306500
VCE306600
Luer lock



Record Cone
VCE307000
VCE307100
Luer lock



Castroviejo
VAG309508
8 cm / 3 1/4"
Measuring range 15 mm



Lagrange
VCE308000



Ophthalmology

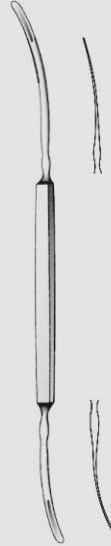
Iris and Cyclodialysis Spatula and Squint Hook
Iris spatel, Zyklotomie spatel, Spatel und Schielhaken
Espátula y fresa y plectanalis, Espátula y gancho plectanico



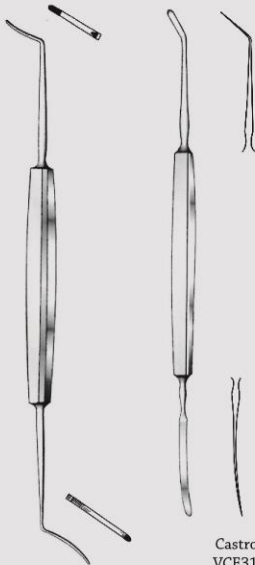
Wheeler
VCE308500



Lindner
VCE309000



Smith-Fisher
VCE309500



Castroviejo
VCE310514
14 cm / 5 1/2"
Castroviejo
VCE310100 0.50 mm
VCE310200 0.75 mm
VCE310300 1.00 mm



Knapp
VCE311000



McReynolds
VCE311515
15 cm / 6"

چشمی
هوک ها



SQS Certificate
ISO 9001:2000
ISO 13485:2003





Ophthalmology

Double Spatula, Needle, Gouge and Spud
Doppelpatel, Nadel, Föhlmeissel und Flöghmeissel
Espatula doble, Aguja y gubia

چشمی



CE

SQS Certificate
ISO 9001:2000
ISO 13485:2003

440



Green
VCE312000



VCE312500



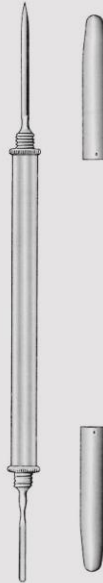
VCE313000



VCE313500



VCE314000



VCE314500



VCE315000



Ophthalmology
Iris Forceps
Irispinzetten
Pinzas para Iris



7 cm / 2¾"
10 cm / 4"

Graefe



VCE315507
VCE315510



VCE315607
VCE315610



VCE315707
VCE315710



VCE315807
VCE315810
1:2 Teeth



VCE315907
VCE315910
1:2 Teeth



VCE316007
VCE316010
1:2 Teeth

چشمی
پنست ها



Stevens
10.5 cm / 4¼"



VCE316110



VCE316210



VCE316310



VCE316410
1:2 Teeth



VCE316510
1:2 Teeth



VCE316610
1:2 Teeth



Stevens
VCE317011
11 cm / 4½"



Stevens
VCE317511
11 cm / 4½"



CE

SQS Certificate
ISO 9001:2000
ISO 13485:2003

441



Ophthalmology
Iris Forceps
Irispinzetten
Pinzas para Iris

چشمی
پنست ها



CE

SQS Certificate
ISO 9001:2000
ISO 13485:2003

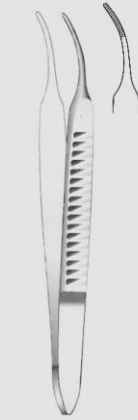
442



VCE318007
VCE318107
VCE318207
7 cm / 2 3/4"
Straight

Graefe

0.5 mm
0.7 mm
1.0 mm



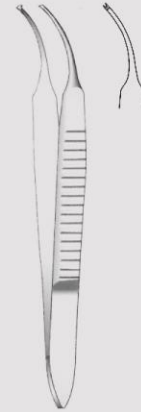
VCE318507
VCE318607
VCE318707
7 cm / 2 3/4"
Curved



VCE319007
VCE319107
VCE319207
7 cm / 2 3/4"
Straight

Graefe

0.5 mm
0.7 mm
1.0 mm



VCE319507
VCE319607
VCE319707
7 cm / 2 3/4"
Curved



Bishop-Harman
VCE320108
8.5 cm / 3 1/2"



Bishop-Harman
VCE320508
8.5 cm / 3 1/2"



Bishop-Harman
VCE321008
8.5 cm / 3 1/2"
Fine



Bishop-Harman
VCE321508
8.5 cm / 3 1/2"
Fine



10 X



Ophthalmology
Iris Forceps
Irispinzetten
Pinzas para Iris



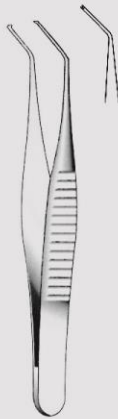
Hess
VCE322009
9 cm / 3½"



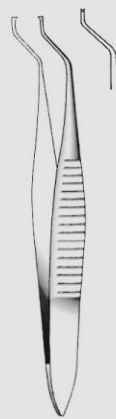
Hess
VCE322509
9 cm / 3½"



Elliot
VCE323010
10 cm / 4"



Hess
VCE323507
7 cm / 2¾"



Hess
VCE324007
7 cm / 2¾"

چشمی
پنست ها



CE

SQS Certificate
ISO 9001:2000
ISO 13485:2003

443



Ophthalmology
Iris Forceps
Irispinzetten
Pinzas para Iris

چشمی
پنست ها

ایزاد جراحی
دایموند

CE

SQS Certificate
ISO 9001:2000
ISO 13485:2003

444



Fischer
VCE324507
7 cm / 2 3/4"



Fischer Airt
VCE325007
7 cm / 2 3/4"



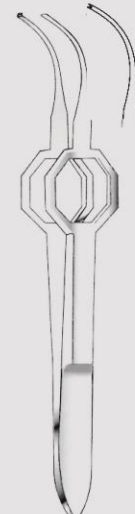
Foerster
VCE325508
8.5 cm / 3 1/4"



Foerster
VCE326008
8.5 cm / 3 1/4"



Foerster
VCE326508
8.5 cm / 3 1/4"
1:2 Teeth



Foerster
VCE327008
8.5 cm / 3 1/4"
1:2 Teeth

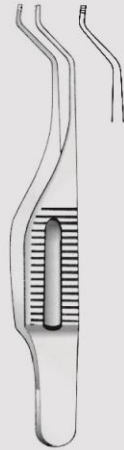


Ophthalmology

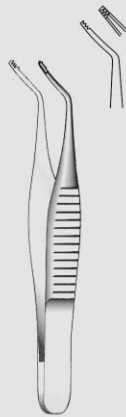
Iris and Capsular Forceps
Irispinzetten und Kapsel-pinzetten
Pinzas para iris y Capsulares



Gill
VCE327507
7.5 cm / 3"
1:2 Teeth



Gill-Hess
VCE328007
7.5 cm / 3"
1:2 Teeth
0.4 mm



Hess
VCE328506
6 cm / 2½"



Hess
VCE329006
6.5 cm / 2½"



Fuchs
VCE329507
7 cm / 2¾"

چشمی
پنست ها



CE

SQS Certificate
ISO 9001:2000
ISO 13485:2003

445



Ophthalmology
Capsular Forceps
Kapselpinzetten
Pinzas Capsulares

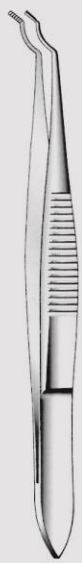
چشمی
پنست ها



CE

SQS Certificate
ISO 9001:2000
ISO 13485:2003

446



Terson
VCE330109
9 cm / 3 1/2"



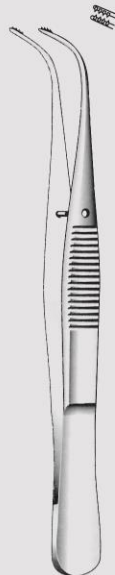
Schweigger
VCE330510
10 cm / 4"



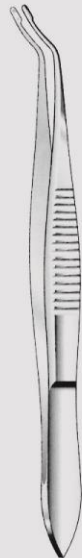
Schweigger
VCE331010
10 cm / 4"



Foerster
VCE331510
10 cm / 4"



Elsching
VCE332010
10 cm / 4"



Arruga
VCE332509
9.5 cm / 3 3/4"



Arruga
VCE333009
9.5 cm / 3 3/4"



Ophthalmology

Tissue and Fixation Forceps
Fasspinzetten und Fixier Fixierpinzetten
Pinzas con dientes y de fijación

چشمی
پنست ها



Elsching
VCE333511
11 cm / 4 1/4"



Graefe
VCE334011
11 cm / 4 1/4"
4.5 mm jaws



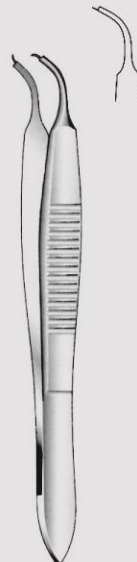
Graefe
VCE334511
11 cm / 4 1/4"
1.5 mm jaws with lock



Guist
VCE335011
11 cm / 4 1/4"
3-4 Teeth



Castroviejo
VCE335509
9 cm / 3 1/2"
1:2 teeth



Castroviejo
VCE336009
9 cm / 3 1/2"

ایزاد جراح
دنیاد

CE

SQS Certificate
ISO 9001:2000
ISO 13485:2003

447



Ophthalmology

Strabismus and Advancement Forceps
Strabismuspinzetten und Vorlagerungspinzetten
Pinza P/estrabismo y Pinzas P/avanzamiento

چشمی
پنست ها



CE

SQS Certificate
ISO 9001:2000
ISO 13485:2003

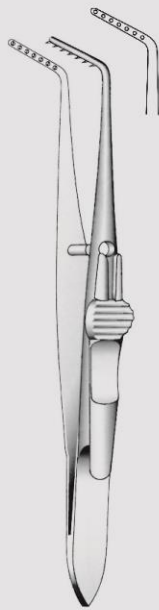
448



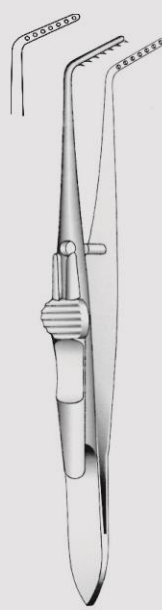
Mc Cullough
VCE336509
9.5 cm / 3 3/4"



Mc Cullough
VCE337009
9.5 cm / 3 3/4"



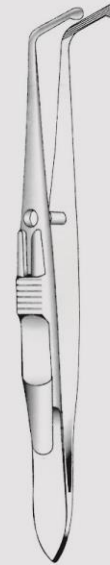
Jameson
VCE337510
10 cm / 4"



Jameson
VCE338010
10 cm / 4"



Worth
VCE338510
10 cm / 4"



Worth
VCE339010
10 cm / 4"



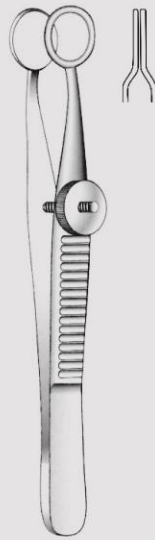
Ophthalmology

Chalazion and Suture Forceps
Chalazion Pinzetten und Fadenpinzetten
Pinzas de chalazion y p/sutura

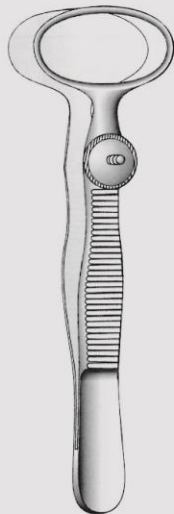
چشمی
پنست ها



Ayer
VCE339509
9 cm / 3½"



Lambert
VCE340109
9 cm / 3½"



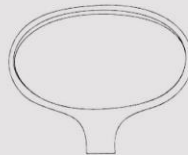
Desmarres
9 cm / 3½"



VCE340509
Small



VCE340609
Medium



VCE340709
Large



Paufigue
VCE341010
10 cm / 4"



CE

SQS Certificate
ISO 9001:2000
ISO 13485:2003

449



Ophthalmology
Entropium and Trachoma Forceps
Entropiumpinzetten und Trachompinzetten
Pinzas p/entropion y p/tracoma

چشمی
پنست ها



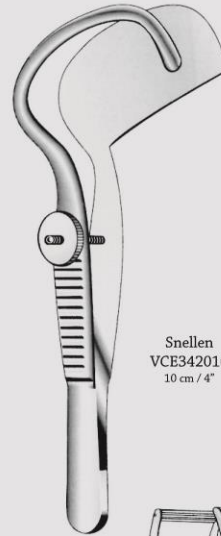
CE

SQS Certificate
ISO 9001:2000
ISO 13485:2003

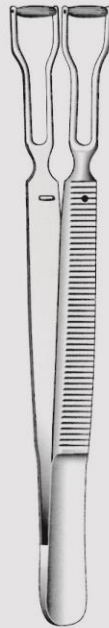
450



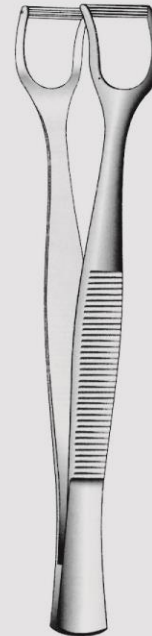
Snellen
VCE341510
10 cm / 4"



Snellen
VCE342010
10 cm / 4"



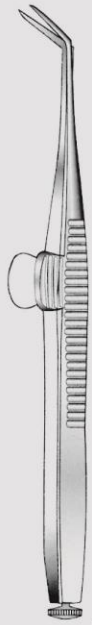
Knapp
VCE342511
11 cm / 4 1/4"



Knapp-Luer
VCE343011
11 cm / 4 1/4"



Ophthalmology
Iris Scissors
Augenscheren
Tijeras p/iridectomia



Wecker
11 cm / 4 1/4"



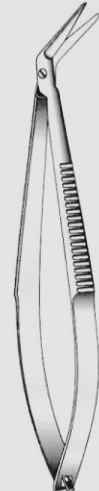
VCE343511
Sharp / Sharp



VCE343611
Sharp / Blunt



VCE343711
Blunt / Blunt



Castroviejo
VCE344009
9 cm / 3 1/2"



Noyes
12 cm / 4 3/4"
Straight



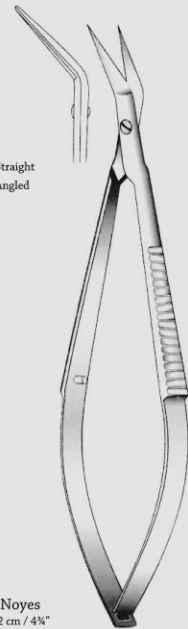
VCE344512 Straight
VCE344612 Angled
Sharp / Sharp
Fig. 1



VCE345012 Straight
VCE345112 Angled
Sharp / Blunt
Fig. 2



VCE345512 Straight
VCE345612 Angled
Blunt/Blunt
Fig. 3



Noyes
12 cm / 4 3/4"
Angled

چشمی
قیچی ها



CE

SQS Certificate
ISO 9001:2000
ISO 13485:2003

451



Ophthalmology

Iridectomy, Tenotomy and Micro Eye Scissors
Iridectomisches, Hirschhautschere und Mikro Fisschere
Tijeras Píradectomia, Pírenotomia y micro Fíris

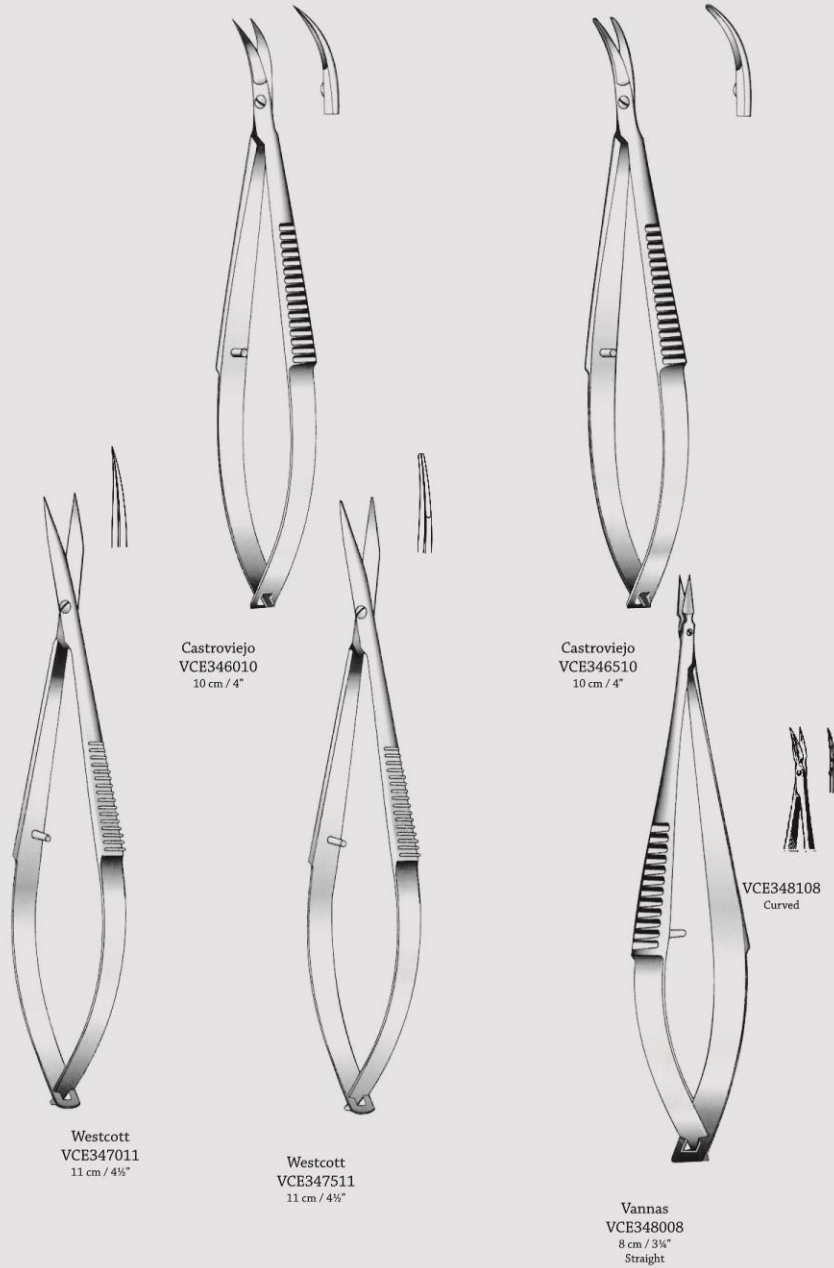
چشمی
قیچی ها



CE

SQS Certificate
ISO 9001:2000
ISO 13485:2003

452



Castroviejo
VCE346010
10 cm / 4"

Castroviejo
VCE346510
10 cm / 4"

VCE348108
Curved

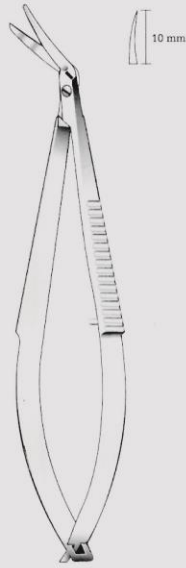
Westcott
VCE347011
11 cm / 4 1/2"

Westcott
VCE347511
11 cm / 4 1/2"

Vannas
VCE348008
8 cm / 3 1/4"
Straight



Ophthalmology
Iris Scissors
Iridektomiescheren
Pinzas tijeras para iridectomia

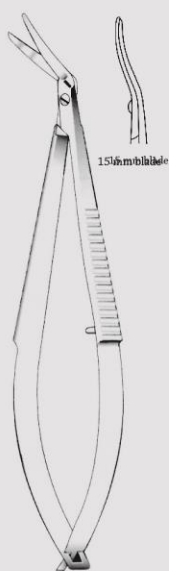


Castroviejo
VCE351011
11 cm / 4 1/4"

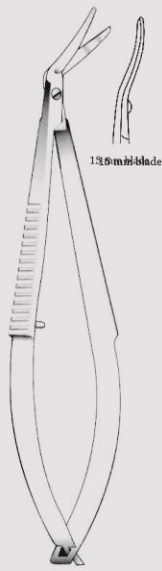


Barraquer
5.5 cm / 2 1/4"

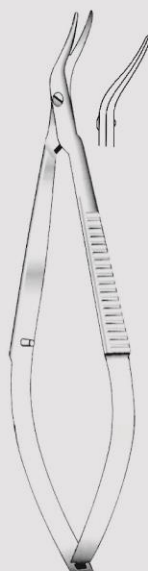
Cutting Blades
VCE348505 5 mm
VCE348605 7 mm
VCE348705 10 mm



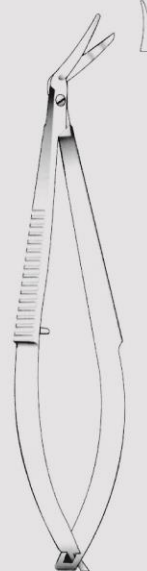
Castroviejo
VCE349010
10 cm / 4"
Right



Castroviejo
VCE349510
10 cm / 4"
Left



Castroviejo
VCE350111
11 cm / 4 1/4"



Castroviejo
VCE350511
11 cm / 4 1/4"

چشمی
قیچی ها



CE

SQS Certificate
ISO 9001:2000
ISO 13485:2003

453



Goitre

Goitre Seizing Forceps & Scissors, Directors, Emucleators
Knopfzangen- und Scheren, Knopfsonden
Pinzas para Coger el bocio y tijeras Sondas acanaladas

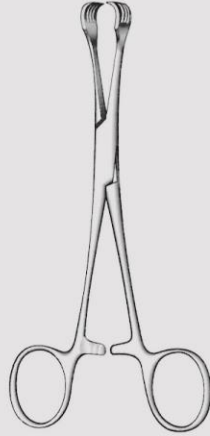
گواتر



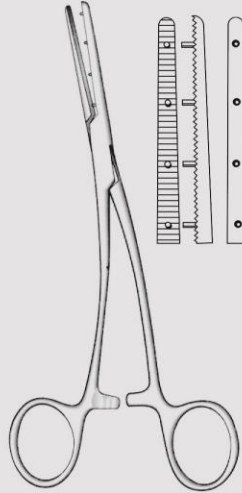
CE

SQS Certificate
ISO 9001:2000
ISO 13485:2003

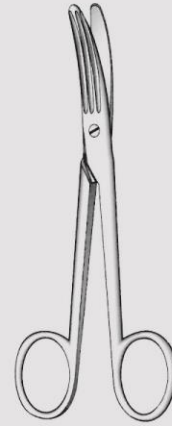
454



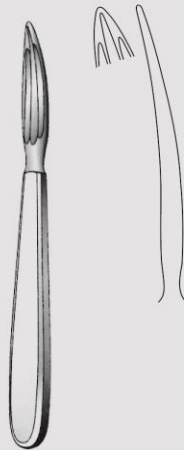
Lahey
VCE351515 15 cm / 6"
VCE351520 20 cm / 8"



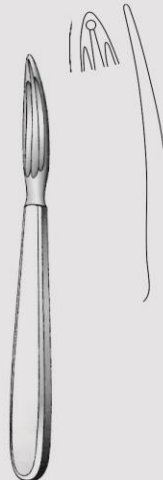
Mastin
VCE352017
17 cm / 6 3/4"



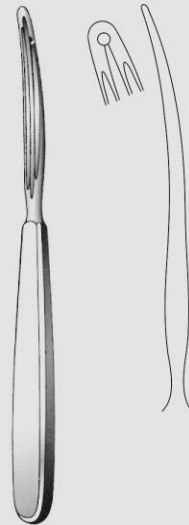
Schoemaker
VCE352515
15 cm / 6"



Kocher
VCE353015 15 cm / 6"
VCE353016 16 cm / 6 1/4"



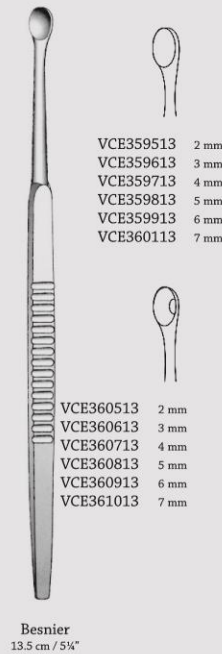
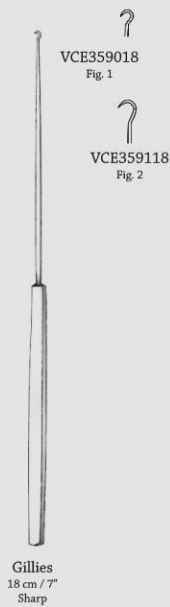
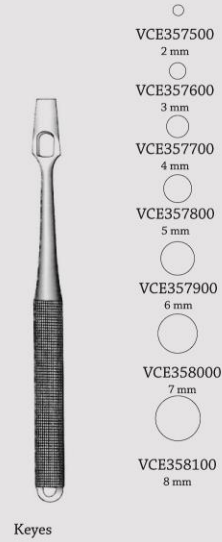
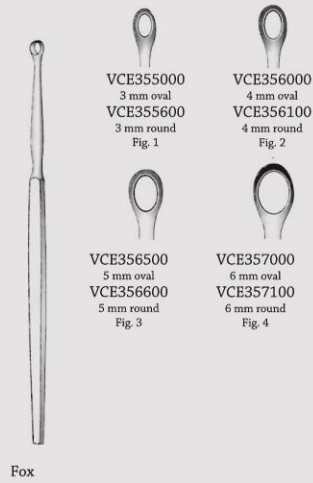
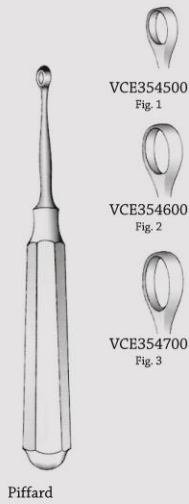
Kocher
VCE353515 15 cm / 6"
VCE353516 16 cm / 6 1/4"
With eye



Kocher
VCE354018
18 cm / 7"



Dermatology
Lupus Currettes, Hooklets
Lupusloffel, Hakchen
Curetas para lupus



ابزار پوستی
کورت ها
پانچ ها
هوک ها



CE

SQS Certificate
ISO 9001:2000
ISO 13485:2003

455



Dermatology
Comedone Extractors
Komedoneninstrumente
Extractores para comedones

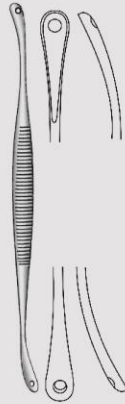
ابزار پوستی



CE

SQS Certificate
ISO 9001:2000
ISO 13485:2003

456



Unna
VCE361514
14 cm / 5½"



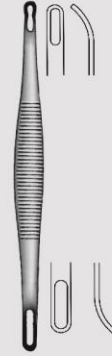
Unna
VCE362014
14 cm / 5½"



Saalfeld
VCE362510
10 cm / 4"



Saalfeld
VCE363014
14 cm / 5½"



Schamberg
VCE363510
10 cm / 4"
Non crimped
VCE363509
9.5 cm / 3¾", Small
Crimped



VCE364013
13 cm / 5"



Katsch
VCE364514
14 cm / 5½"



Greg
VCE365012
12.7 cm / 5"
One fenestrated cup and chuck with
interchangeable No. 65 lancet blade,
protected by cap



Schamberg
VCE365509
9.5 cm / 3¾"
With square loop ends



Schamberg
9.5 cm / 3¾"
VCE366009
Standard pattern with
crimped small loop
VCE366109
Standard pattern with extra fine loop
small loop crimped

DIAMOND SURGICAL
WWW.DIAMONDMED.IR INSTRUMENTS



VCF-VCG

VCH-VCI

Otology, Rhinology

Oral Instruments

Tonsil



CE

SQS Certificate
ISO 9001:2000
ISO 13485:2003

457



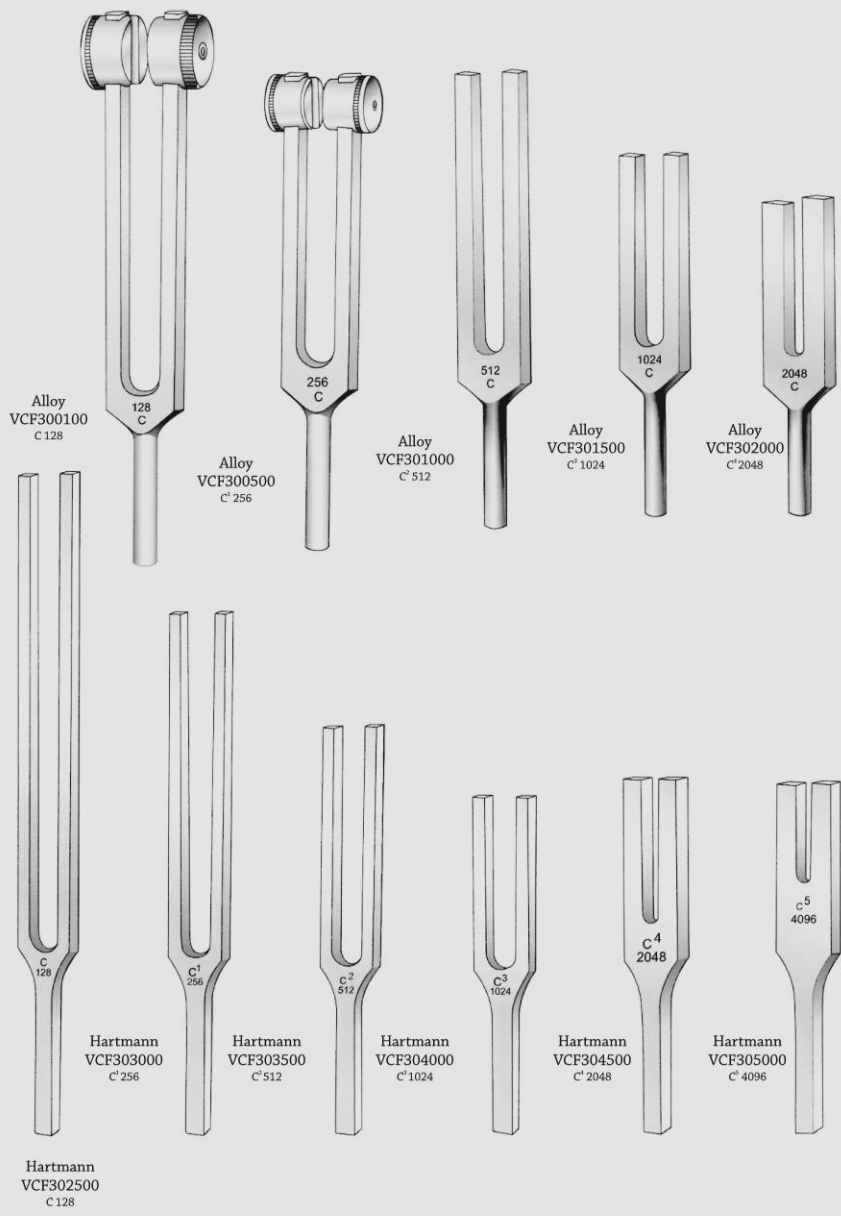
Otology
Tuning Forks
Stimmgabeln
Diapasones

اتولوژی
شنوایی
دیاپازون



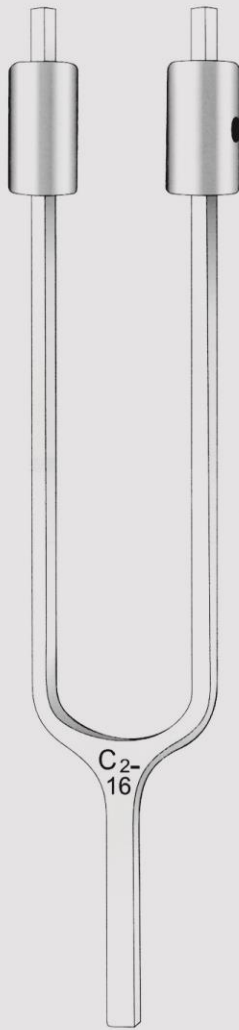
SQS Certificate
ISO 9001:2000
ISO 13485:2003

458

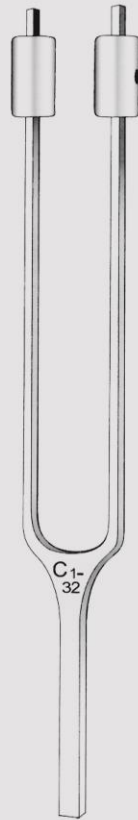




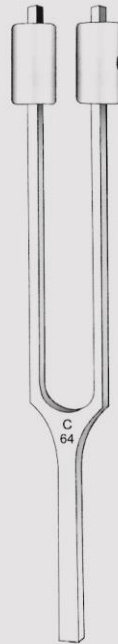
Otology
Tuning Forks
Stimmgabeln
Diapasones



French
VCF305500
C₂, 16



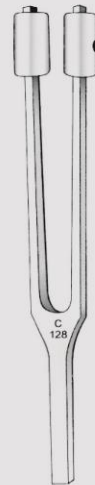
French
VCF306000
C₁, 32



Hartmann
VCF306300
C 64



Hartmann
VCF307000
C' 256



Hartmann
VCF306500
C 128

اوتولوژی
شنوایی
دیاپازون



SQS Certificate
ISO 9001:2000
ISO 13485:2003

459



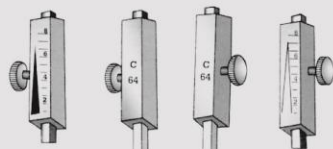
Otology
Tuning Forks
Stimmgabeln
Diapasones

اتولوژی
شنوایی
دیاپازون

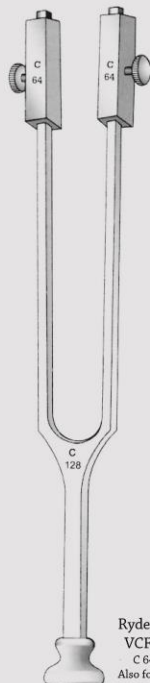


SQS Certificate
ISO 9001:2000
ISO 13485:2003

460



Lucae
VCF309000
C 128



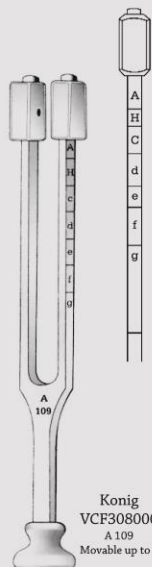
Rydel-Seiffert
VCF307500
C 64 / C 128
Also for neurology



Lucae
VCF309500
C 256



Lucae
VCF310100
C 512



Konig
VCF308000
A 109
Movable up to g



Lucae
VCF310500
C 1024



Lucae
VCF311000
C 2048



Lucae
VCF311500
C 4096



VCF308500
a 1 440



Otology
Ear Specula
Ohrspekula
Especulos auriculares

اوتولوژی
شنوایی
اسپکلوم ها



SQS Certificate
ISO 9001:2000
ISO 13485:2003

461



Troeltsch
VCF312000
Set of 3



VCF312100
6 mm Ø
Fig. 1



VCF312200
7 mm Ø
Fig. 2



VCF312300
8 mm Ø
Fig. 3



Hartmann
VCF312500
Set of 5



VCF312600
3 mm Ø
Fig. 1



VCF312700
4 mm Ø
Fig. 2



VCF312800
5 mm Ø
Fig. 3



VCF312900
6 mm Ø
Fig. 4



VCF313000
7 mm Ø
Fig. 5



Hartmann
VCF313500
Set of 4



VCF313600
4.5 mm Ø
Fig. 1



VCF313800
6.5 mm Ø
Fig. 3



VCF313700
5.5 mm Ø
Fig. 2



VCF313900
7.5 mm Ø
Fig. 4



Toynbee
VCF314000
Set of 5



VCF314100
4.5 mm Ø
Fig. 1



VCF314300
6.5 mm Ø
Fig. 3



VCF314200
5.5 mm Ø
Fig. 2



VCF314400
7.5 mm Ø
Fig. 4



Politzer
VCF315000
Set of 4



VCF315100
3 mm Ø
Fig. 1



VCF315300
5.5 mm Ø
Fig. 3



VCF315200
4.5 mm Ø
Fig. 2



VCF315400
6.5 mm Ø
Fig. 4



Pritchard
VCF316000
Set of 3



VCF316100
4.5 mm Ø
Fig. 1



VCF316200
6.5 mm Ø
Fig. 2



VCF316300
7.5 mm Ø
Fig. 3



Erhardt
VCF316500 Round
VCF317000 Oval
Set of 3



VCF316600
4.5 mm Ø
Fig. 1



VCF316700
5.5 mm Ø
Fig. 3



VCF316800
6.5 mm Ø
Fig. 5



VCF317100
4.5 mm Ø
Fig. 2



VCF317200
5.5 mm Ø
Fig. 4



VCF317300
6.5 mm Ø
Fig. 6



Graber
VCF317500 Round
VCF318500 Oval
Set of 3



VCF317600
4.5 mm Ø
Fig. 1



VCF317700
5.5 mm Ø
Fig. 3



VCF317800
6.5 mm Ø
Fig. 5



VCF317900
7.5 mm Ø
Fig. 7



VCF318600
4.5 mm Ø
Fig. 2



VCF318700
5.5 mm Ø
Fig. 4



VCF318800
6.5 mm Ø
Fig. 6



VCF318900
7.5 mm Ø
Fig. 8



Otology

Ear Specula Storage Rack

Ohrspekulaständer

Soporte para especulos auriculares

اتولوژی
شنوایی
اسپکلوم ها



SQS Certificate
ISO 9001:2000
ISO 13485:2003

462

VCF319600
5.5 x 6.5 mm
Fig. 1



VCF319700
6.5 x 7.5 mm
Fig. 2



VCF320503
5.5 mm Ø
Fig. 1



VCF320603
6.5 mm Ø
Fig. 2



VCF319800
7.5 x 8.5 mm
Fig. 3



VCF319900
8.5 x 9.5 mm
Fig. 4



VCF320703
7.5 mm Ø
Fig. 3



VCF320803
8.5 mm Ø
Fig. 4



VCF320100
9.5 x 10.5 mm
Fig. 5



VCF320200
10.5 x 11.5 mm
Fig. 6



VCF320903
9.5 mm Ø
Fig. 5



VCF321003
10.5 mm Ø
Fig. 6



VCF321103
11.5 mm Ø
Fig. 7



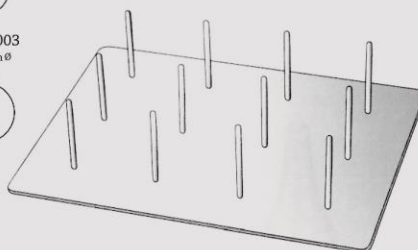
VCF321203
Set of 7 pieces



Zollner
VCF319500
3.8 cm / 1 1/2"
Set of 6 pieces
Oval, Black



Farrior
3.6 cm / 1 1/2"
Black



VCF321500
Ear specula storage rack

VCF322100
3 x 4 mm
Fig. 1



VCF322200
4 x 5 mm
Fig. 2



VCF322300
4.5 x 5.5 mm
Fig. 3



VCF322400
5 x 6 mm
Fig. 4



VCF322500
5.5 x 6.5 mm
Fig. 5



VCF322600
6 x 7 mm
Fig. 6



VCF322700
6.5 x 7.5 mm
Fig. 7



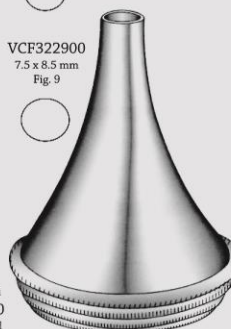
VCF322800
7 x 8 mm
Fig. 8



VCF322900
7.5 x 8.5 mm
Fig. 9



VCF322000
Oval, angled end
Set of 9 pieces



Boucheron
VCF323500
Set of 4, round

VCF323600
Round
Fig. 1



VCF323700
Round
Fig. 2



VCF323800
Round
Fig. 3



VCF323900
Round
Fig. 4





Otology

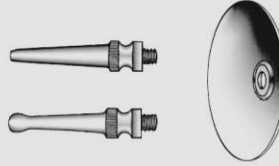
Specula and Syringes-Eustachian Catheters
Spektula und Spritzen-Ohrkatheter
Especulos y Jeringas Sondas auriculares



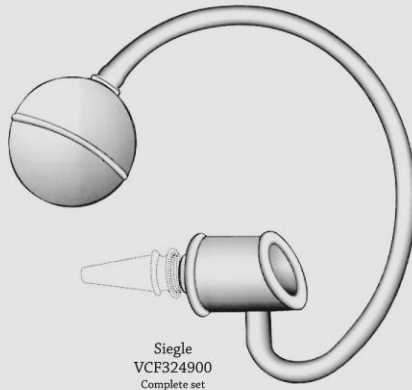
VCF324600
6.5 mm Ø

VCF324700
7 mm Ø

VCF324800
8 mm Ø

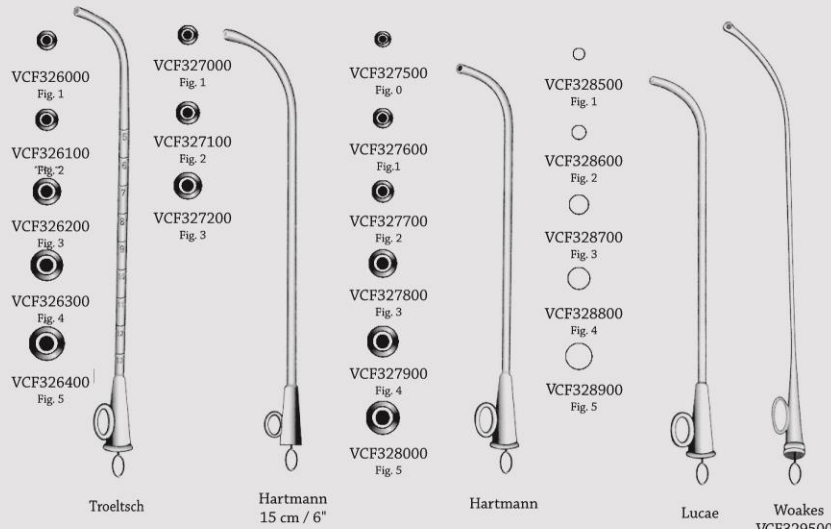


Pimeroy
VCF325000 50 c.c.
VCF325100 75 c.c.
VCF325200 100 c.c.
VCF325300 150 c.c.
VCF325400 200 c.c.



Siegle
VCF324900
Complete set

Siegle
VCF324500



VCF326000
Fig. 1

VCF326100
Fig. 2

VCF326200
Fig. 3

VCF326300
Fig. 4

VCF326400
Fig. 5

Troeltsch

VCF327000
Fig. 1

VCF327100
Fig. 2

VCF327200
Fig. 3

Hartmann
15 cm / 6"

VCF327500
Fig. 0

VCF327600
Fig. 1

VCF327700
Fig. 2

VCF327800
Fig. 3

VCF327900
Fig. 4

VCF328000
Fig. 5

Hartmann

VCF328500
Fig. 1

VCF328600
Fig. 2

VCF328700
Fig. 3

VCF328800
Fig. 4

VCF328900
Fig. 5

Lucae

Woakes
VCF329500

اتولوژی
شنوایی
سرنگ گوش



SQS Certificate
ISO 9001:2000
ISO 13485:2003





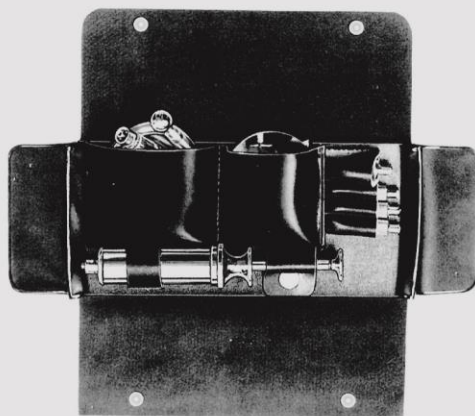
Otology
Ear Syringes
Ohrspritzen
Jeringas auriculares

اتولوژی
شنوایی
سرنگ گوش

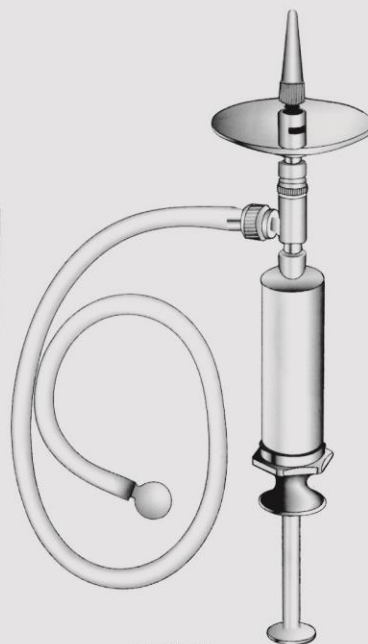


SQS Certificate
ISO 9001:2000
ISO 13485:2003

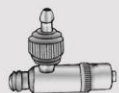
464



VCF330100
Ear syringe, complete
self filling in plastic pouch



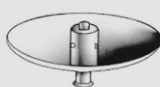
VCF330500
Flexible tube



VCF331000
Valve attachment



VCF331500
Suction nozzle



VCF332000
Protecting disc



VCF332500
Metal olive



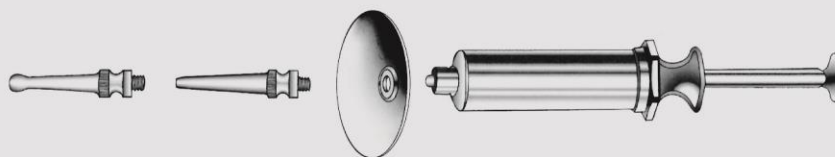
VCF333000
Conical tip



VCF333500
Button ended tip



VCF334000
Threaded tip



VCF334500 50 ml
VCF334600 75 ml
VCF334700 100 ml
Ear syringe, complete with
protecting disc and 2 tips



Otology
Air Bags
Luftduschen
Insufladores de aire



VCF335500
Connecting nozzle



VCF336000
4 mm Ø
Ear olive



VCF336500
15 mm Ø
Nose olive



VCF337000
17 mm Ø
Nose olive



VCF337500
22 mm Ø
Nose olive



VCF335000
Complete set
Poltizer
VCF335100

اتولوژی
شنوایی



CE

SQS Certificate
ISO 9001:2000
ISO 13485:2003

465



Otology

Micro Ear Needles, Micro Ear Hooks
Mikro-Ohrnadeln, Mikro Ohrhaken
Micro agujas auriculares, Micro ganchitos auriculares

اتولوژی
شنوایی
هوک ها



SQS Certificate
ISO 9001:2000
ISO 13485:2003

466



Barbara
VCF338016

25°

VCF340116 0.3 mm
VCF340216 0.6 mm
VCF340316 1.0 mm

Barbara
16 cm / 6 1/4"



Barbara
VCF338516

45°

VCF340516 0.3 mm
VCF340616 0.6 mm
VCF340716 1.0 mm
VCF340816 1.2 mm
VCF340916 1.5 mm
VCF341016 2.0 mm
VCF341116 2.5 mm



Barbara
VCF339016

90°

VCF341516 0.3 mm
VCF341616 0.6 mm
VCF341716 1.0 mm
VCF341816 1.2 mm
VCF341916 1.5 mm
VCF342016 2.0 mm
VCF342116 2.5 mm



Rosen
VCF339516
16 cm / 6 1/4"



VCF342516 0.5 mm
VCF342616 1.0 mm



90°

VCF343015 0.3 mm
VCF343115 0.6 mm
VCF343215 1.0 mm

15.5 cm / 6"



90°

VCF343515 0.3 mm
VCF343615 0.6 mm
VCF343715 1.0 mm

McGee
VCF344015 0.5 mm
VCF344115 1.0 mm
For footplate

McGee
VCF344515 0.5 mm
VCF344615 1.0 mm
For footplate



VCF345015



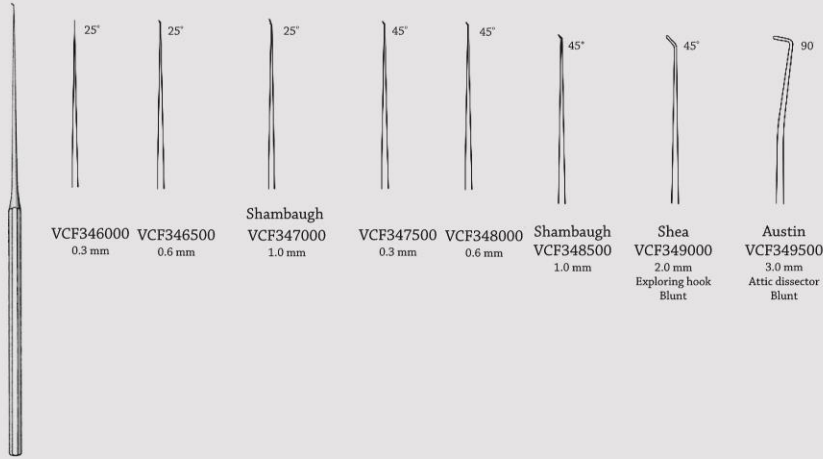
VCF345515

Barbara
15.5 cm / 6"



Otology

Micro Ear Hooks, Micro Dissectors
Mikro Ohrhaken, Mikro-Dissektoren
Micro ganchitos auriculares, Micro disecadores



VCF346000
0.3 mm

VCF346500
0.6 mm

Shambaugh
VCF347000
1.0 mm

VCF347500
0.3 mm

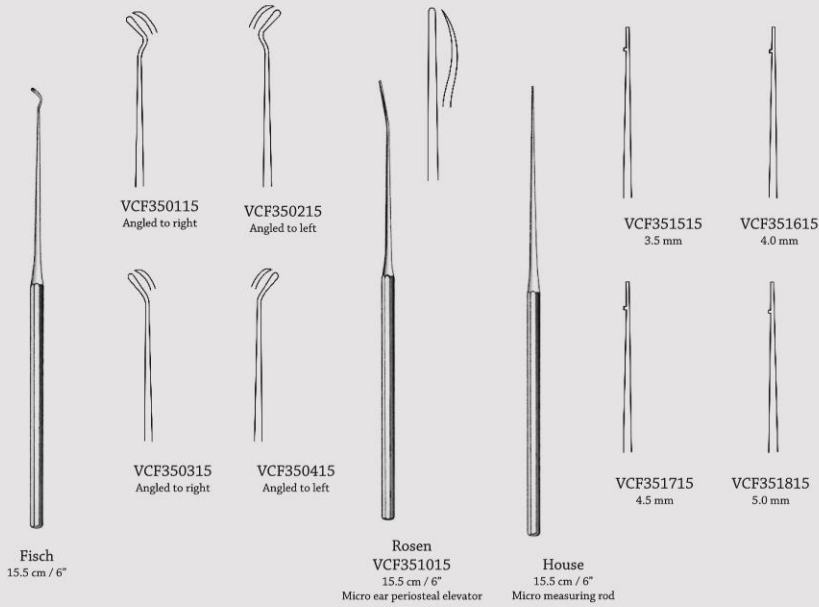
VCF348000
0.6 mm

Shambaugh
VCF348500
1.0 mm

Shea
VCF349000
2.0 mm
Exploring hook
Blunt

Austin
VCF349500
3.0 mm
Attic dissector
Blunt

اتولوژی
شنوایی
هوک ها



VCF350115
Angled to right

VCF350215
Angled to left

VCF351515
3.5 mm

VCF351615
4.0 mm

VCF350315
Angled to right

VCF350415
Angled to left

VCF351715
4.5 mm

VCF351815
5.0 mm

Fisch
15.5 cm / 6"

Rosen
VCF351015
15.5 cm / 6"
Micro ear periosteal elevator

House
15.5 cm / 6"
Micro measuring rod



CE

SQS Certificate
ISO 9001:2000
ISO 13485:2003

467



Otology

Micro Curettes, Tympanum Needles
Mikro-Karetten, Trommelfelnnadeln
Micro cucharillas, Aguja para timpano

اتولوژی
شنوایی
کورت ها



CE

SQS Certificate
ISO 9001:2000
ISO 13485:2003

468



House
14.5 cm / 5 3/4"



VCF352014
1.0/1.2 mm



VCF352114
1.5/1.8 mm



House
14.5 cm / 5 3/4"



VCF352514
1.0/1.2 mm



VCF352614
1.5/1.8 mm



Langenbeck
VCF353013
13 cm / 5"
Blunt



Shapleigh
15 cm / 6"
Ear curette
Delicate



VCF353515
2.5 mm



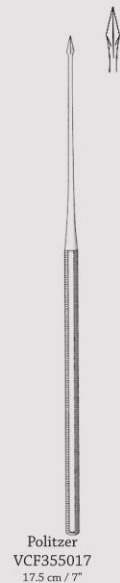
VCF353615
3.5 mm



Jansen
VCF354017
17 cm / 6 3/4"
Sharp



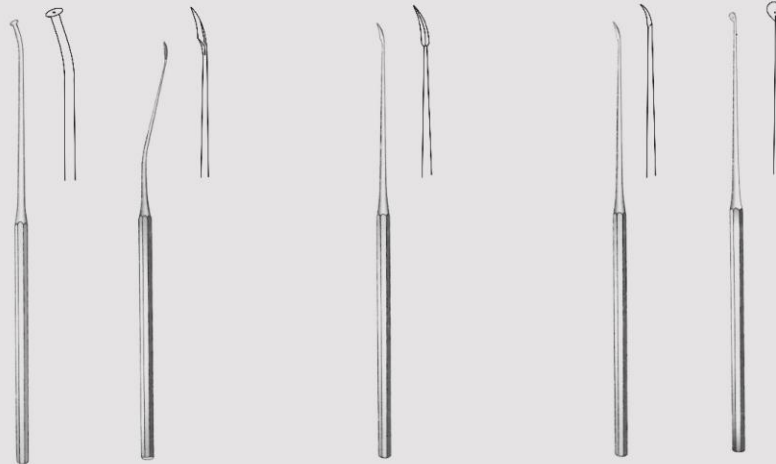
Poltzer
VCF354514
14.5 cm / 5 3/4"
Furuncle knife



Poltzer
VCF355017
17.5 cm / 7"



Otology
Micro Ear Knives
Mikro-Ohrmesser
Micro cuchillos auriculares



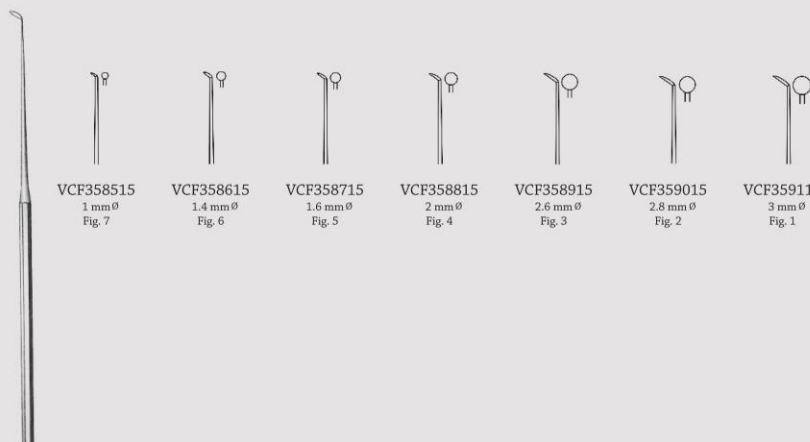
Schuknecht
VCF356000
Rotary knife

Schuknecht
VCF356514
14.5 cm / 5 3/4"
Sickle knife

Wullstein
VCF357015
15.5 cm / 6"
Sickle knife

Tabb
VCF357500
Mucosa knife

Plester
VCF358015
15 cm / 6"
Flap knife



VCF358515
1 mm Ø
Fig. 7

VCF358615
1.4 mm Ø
Fig. 6

VCF358715
1.6 mm Ø
Fig. 5

VCF358815
2 mm Ø
Fig. 4

VCF358915
2.6 mm Ø
Fig. 3

VCF359015
2.8 mm Ø
Fig. 2

VCF359115
3 mm Ø
Fig. 1

Rosen
15 cm / 6"
Circular cut knives



CE

SQS Certificate
ISO 9001:2000
ISO 13485:2003

469



Otology

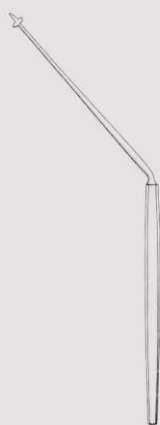
Tympanum Needles, Currettes and Scoop
Trommelfellnadeln, Kuretten, Löffel
Agujas para tímpano y Curretas y Cuchillas

اتولوژی
شنوایی
چاقوها
کورت ها
لوپ ها



SQS Certificate
ISO 9001:2000
ISO 13485:2003

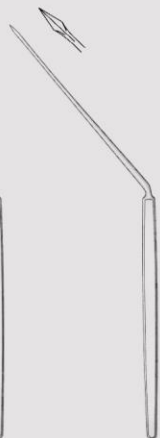
470



Troeltsch
VCF359518
18 cm / 7"



Poltzer
VCF360116
16.5 cm / 6 1/2"



Poltzer
VCF360516
16.5 cm / 6 1/2"
Needle horizontal



Lucae
VCF361018
18 cm / 7"



Lucae
VCF361518
18 cm / 7"



Barker
VCF362017
17 cm / 6 3/4"



Gross
VCF362512
12 cm / 4 3/4"
Blunt / Sharp



Gross
VCF363012
12 cm / 4 3/4"
Ear scoop / hook
Blunt



Gross
VCF363512
12 cm / 4 3/4"
Blunt



Gross
VCF364012
12 cm / 4 3/4"
Blunt / Sharp



Gross
VCF364512
12 cm / 4 3/4"



Billeau
16.5 cm / 6 1/2"
Ear loop

VCF365016
2.75 mm

VCF365116
3.75 mm

VCF365216
5.5 mm

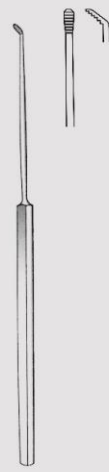


Otology

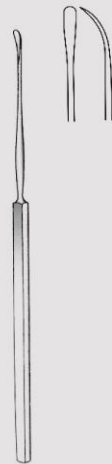
Foreign Body Instruments
Fremdkörperinstrumente
Instrumentos para cuerpos extraños



Weber-Loch
VCF365516
16.5 cm / 6½"
Ear loop



Moldenhauer
VCF366015
15.5 cm / 6"
Foreign body lever



Zaufal
VCF366515
15 cm / 6"
Foreign body lever



Hartmann
VCF367016
16 cm / 6¼"
Sharp, ear hooklet

اتولوژی
شنوایی
الویتورها



CE

SQS Certificate
ISO 9001:2000
ISO 13485:2003

471



Otology
Ear Hooklets
Ohrhakchen
Ganchitos auriculares

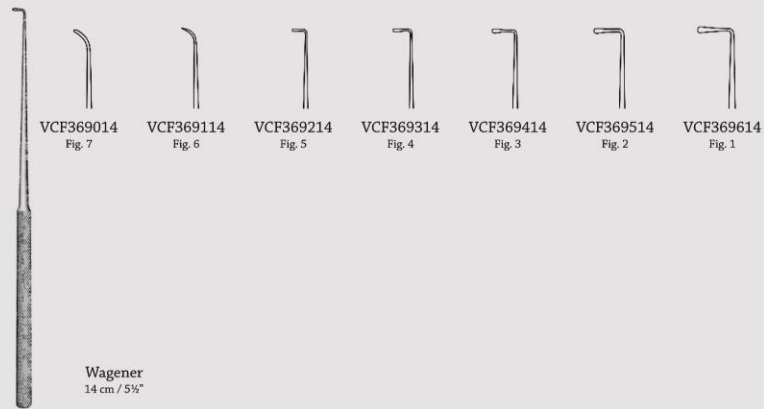
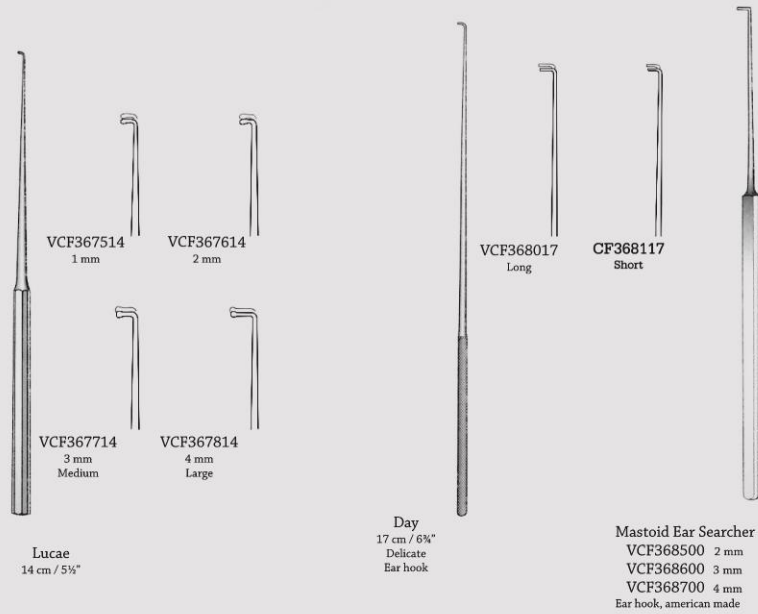
اتولوژی
شنوایی
هوک ها



CE

SQS Certificate
ISO 9001:2000
ISO 13485:2003

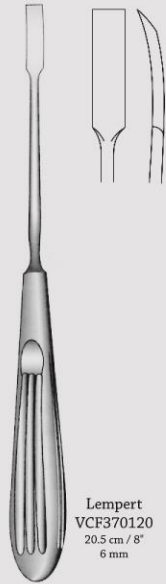
472



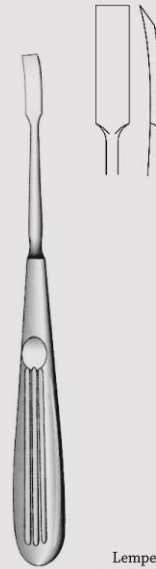


Otology

Ear Periosteal Elevators, Ear Scoops
Ohrraspatorien, Ohrloeffel
Legras auriculares, Cucharillas auriculares



Lempert
VCF370120
20.5 cm / 8"
6 mm



Lempert
VCF370518
18 cm / 7"
6 mm

○
VCF371421

○
VCF371321

○
VCF371221

○
VCF371121

○
VCF371021

Lempert
21.5 cm / 8½"
Sharp



اتولوژی
شنوایی
پریوست الویتورها
کورتها



CE

SQS Certificate
ISO 9001:2000
ISO 13485:2003

473



Otology
Ear Curettes
Ohrkuretten
Curetas auriculares



اتولوژی
شنوایی
کورت ها



CE
SQS Certificate
ISO 9001:2000
ISO 13485:2003











Buck
16.5 cm / 6 1/2"

- | | |
|---|---|
|  |  |
| VCF372016 Fig. 000 | VCF373016 |
| VCF372116 Fig. 00 | VCF373116 |
| VCF372216 Fig. 0 | VCF373216 |
| VCF372316 Fig. 1 | VCF373316 |
| VCF372416 Fig. 2 | VCF373416 |
| VCF372516 Fig. 3 | VCF373516 |
| VCF372616 Fig. 4 | VCF373616 |
| VCF372716 Fig. 5 | VCF373716 |

Blunt



Sharp

- | | | | |
|---|---|---|---|
|  |  |  |  |
| Fig. 000 | Fig. 00 | Fig. 0 | Fig. 1 |
|  |  |  |  |
| Fig. 2 | Fig. 3 | Fig. 4 | Fig. 5 |

- | | |
|---|---|
|  |  |
| VCF374016 Fig. 000 | VCF376016 Fig. 000 |
| VCF374116 Fig. 00 | VCF376116 Fig. 00 |
| VCF374216 Fig. 0 | VCF376216 Fig. 0 |
| VCF374316 Fig. 1 | VCF376316 Fig. 1 |
| VCF374416 Fig. 2 | VCF376416 Fig. 2 |
| VCF374516 Fig. 3 | VCF376516 Fig. 3 |
| VCF374616 Fig. 4 | VCF376616 Fig. 4 |
| VCF374716 Fig. 5 | VCF376716 Fig. 5 |

Round handle
Blunt

Octagonal handle
Blunt

- | | |
|---|---|
|  |  |
| VCF375016 Fig. 000 | VCF377016 Fig. 000 |
| VCF375116 Fig. 00 | VCF377116 Fig. 00 |
| VCF375216 Fig. 0 | VCF377216 Fig. 0 |
| VCF375316 Fig. 1 | VCF377316 Fig. 1 |
| VCF375416 Fig. 2 | VCF377416 Fig. 2 |
| VCF375516 Fig. 3 | VCF377516 Fig. 3 |
| VCF375616 Fig. 4 | VCF377616 Fig. 4 |
| VCF375716 Fig. 5 | VCF377716 Fig. 5 |

Round handle
Sharp

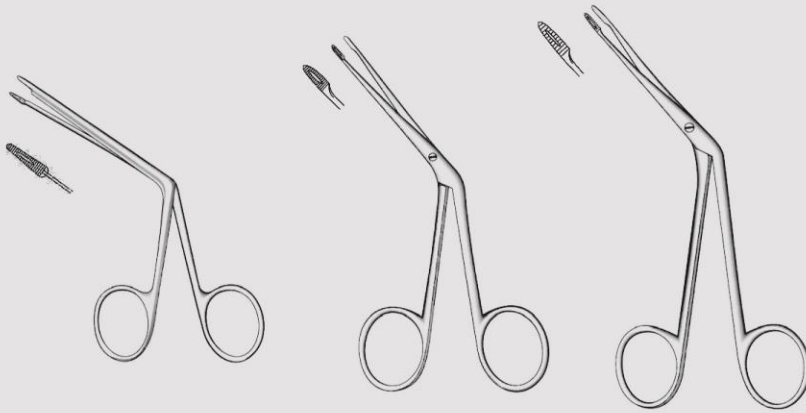
Octagonal handle
Sharp

Buck
16.5 cm / 6 1/2"
extra extra fine

Buck
16.5 cm / 6 1/2"

Myles
17 cm / 6 3/4"

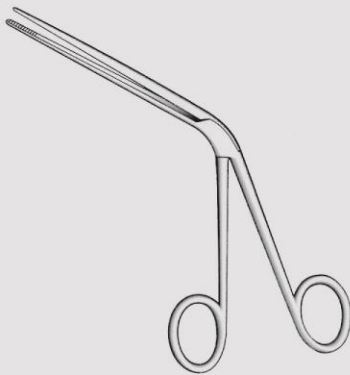
- | | |
|---|-----------|
|  | VCF378017 |
|  | VCF378117 |
|  | VCF378217 |
|  | VCF378317 |
|  | VCF378417 |



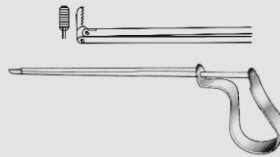
Littauer
VCF379012
12 cm / 4 3/4"

Hartmann
VCF379512
12 cm / 4 3/4"
Fine model

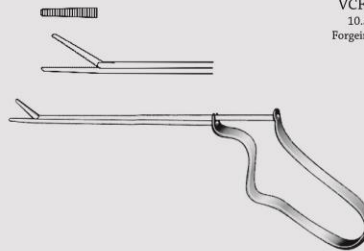
Hartmann
VCF380114
14 cm / 5 1/2"
Regular model



Tilley
VCF380516
16.5 cm / 6 1/2"



Quire
VCF381000
10.5 cm / 4"
Forgein body lever



Buck
VCF381500
11.5 cm / 4 1/2"
Forgein body forceps



Otology

Ear Polypus Snares and Foreign Body Forceps
Polypenzangen, Fremdkörperhebel
Pinzas para polipos, Elevadores para cuerpos extraños

اتولوژی
شنوایی
پنس ها



CE

SQS Certificate
ISO 9001:2000
ISO 13485:2003

475



Otology
 Ear Polypus Forceps
 Ohrpolypenzangen
 Pinzas para polipos auriculares

اتولوژی
 شنوایی
 پنس ها



CE

SQS Certificate
 ISO 9001:2000
 ISO 13485:2003

476



Hartmann
 VCF382008 8.5 cm / 3 1/2"
 VCF382012 12 cm / 4 3/4"
 VCF382014 14 cm / 5 1/2"
 VCF382016 16.5 cm / 6 1/2"



Hartmann Wullstein
 VCF382508 8.5 cm / 3 1/2"



Hartmann Wullst
 VCF383008 8.5 cm / 3 1/2"



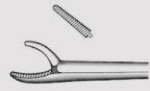
Hartmann
 VCF383508 8.5 cm / 3 1/2"
 VCF383512 12 cm / 4 3/4"
 VCF383514 14 cm / 5 1/2"
 1:2 Teeth



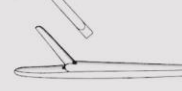
Hartmann Noyes
 VCF384009 9 cm / 3 1/2"



Hartmann Noyes
 VCF384509 9 cm / 3 1/2"
 1:2 Teeth



Hartmann Weingartner
 VCF385008 8.5 cm / 3 1/2"



Hartmann
 VCF385508 8.5 cm / 3 1/2"



Hartmann
 VCF386008 8.5 cm / 3 1/2"
 VCF386012 12 cm / 4 3/4"
 VCF386014 14 cm / 5 1/2"
 2 mm Ø
 VCF386108 8.5 cm / 3 1/2"
 VCF386112 12 cm / 4 3/4"
 VCF386114 14 cm / 5 1/2"
 2.5 mm Ø
 VCF386208 8.5 cm / 3 1/2"
 VCF386212 12 cm / 4 3/4"
 VCF386214 14 cm / 5 1/2"
 3 mm Ø



Hartmann
 VCF386508 8.5 cm / 3 1/2"



Struempel
 VCF387008 8.5 cm / 3 1/2"



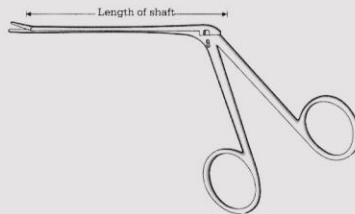
Hartmann
 VCF387508 8.5 cm / 3 1/2"



Hartmann
 VCF388008 8.5 cm / 3 1/2"



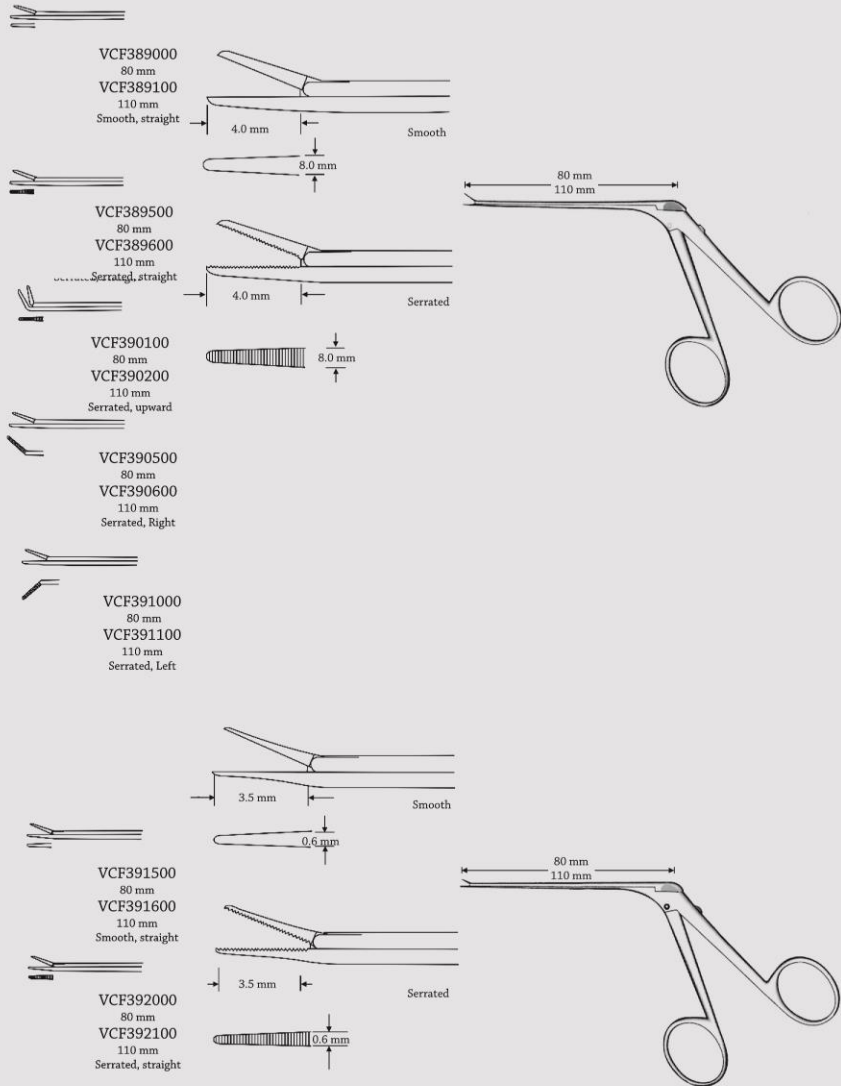
Hartmann Hoffmann
 VCF388508 8.5 cm / 3 1/2"



Hartmann



Otology
Micro Ear Forceps
Mikro-Ohrzangchen
Micro pinzas auriculares



Mini-McGee

اتولوژی
شنوایی
پنس ها



CE

SQS Certificate
ISO 9001:2000
ISO 13485:2003





Otology
Micro Ear Forceps
Mikro-Ohrzangchen
Micro pinzas auriculares

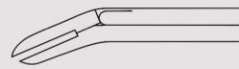
اتولوژی
شنوایی
پنس ها



CE

SQS Certificate
ISO 9001:2000
ISO 13485:2003

478

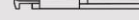
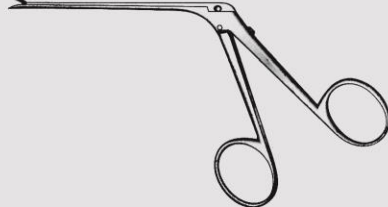


VCF392500
VCF392600 Black finish
80 mm
VCF392700
VCF392800 Black finish
110 mm
0.8 x 3.5 mm



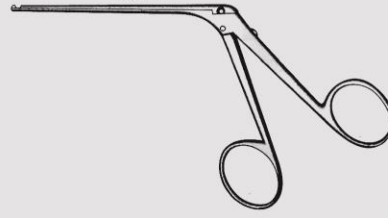
VCF393000
VCF393100 Black finish
80 mm
VCF393200
VCF393300 Black finish
110 mm
0.8 x 6 mm

80 mm
110 mm



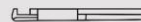
VCF393500
VCF393600 Black finish
80 mm
VCF393700
VCF393800 Black finish
110 mm
Downward cutting
VCF394000
VCF394100 Black finish
80 mm
VCF394200
VCF394300 Black finish
110 mm
Upward cutting

80 mm
110 mm



McGee
Wire bending forceps
bends downward

House-Dieter
Malleus nipper



VCF394500 Right cutting
VCF394600 Right, black finish
80 mm
VCF394700 Right cutting
VCF394800 Right, black finish
110 mm

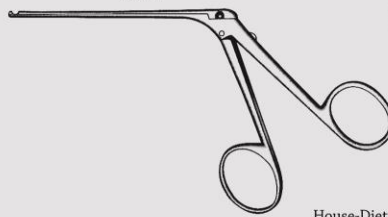


VCF395500
VCF395600 Black finish
80 mm
VCF396000
VCF396100 Black finish
110 mm
For teflon prosthesis

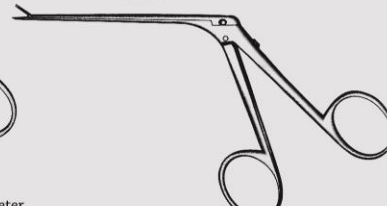


VCF395000 Left cutting
VCF395100 Left, black finish
80 mm
VCF395200 Left cutting
VCF395300 Left, black finish
110 mm

80 mm
110 mm

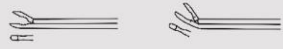


80 mm
110 mm



House-Dieter
Malleus nipper

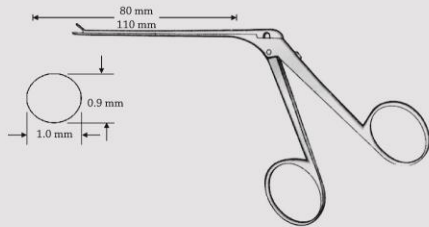
Fuller
Introducing forceps



VCF396500	80 mm	VCF397000
Straight		Curved up
VCF396600	80 mm	VCF397100
Straight, black finish		Curved up, black finish
VCF396700	110 mm	VCF397200
Straight		Curved up
VCF396800	110 mm	VCF397300
		Curved up, black finish

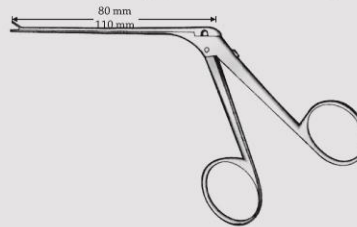


VCF397500	80 mm	VCF398000
Right		Left
VCF397600	80 mm	VCF398100
Right, black finish		Left, black finish
VCF397700	110 mm	VCF398200
Right		Left
VCF397800	110 mm	VCF398300
Right, black finish		Left, black finish



VCF398500	80 mm	VCF399000
Straight		Curved up
VCF398600	80 mm	VCF399100
Straight, black finish		Curved up, black finish
VCF398700	110 mm	VCF399200
Straight		Curved up
VCF398800	110 mm	VCF399300
		Curved up, black finish

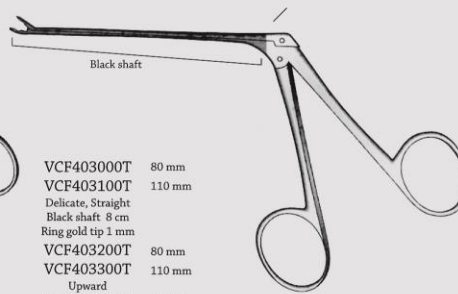
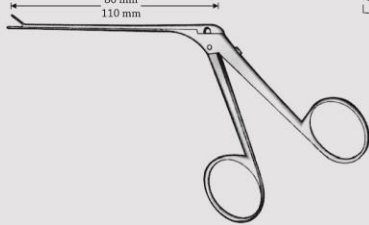
VCF399500	80 mm	VCF400100
Right		Left
VCF399600	80 mm	VCF400200
Right, black finish		Left, black finish
VCF399700	110 mm	VCF400300
Right		Left
VCF399800	110 mm	VCF400400
Right, black finish		Left, black finish



VCF401000	80 mm	VCF401500
Straight		Curved up
VCF401100	80 mm	VCF401600
Straight, black finish		Curved up, black finish
VCF401200	110 mm	VCF401700
Straight		Curved up
VCF401300	110 mm	VCF401800
Straight, black finish		Curved up, black finish



VCF402000	80 mm	VCF402500
Right		Left
VCF402100	80 mm	VCF402600
Right, black finish		Left, black finish
VCF402200	110 mm	VCF402700
Right		Left
VCF402300	110 mm	VCF402800
Right, black finish		Left, black finish



VCF403000T	80 mm
VCF403100T	110 mm
Delicate, Straight	
Black shaft 8 cm	
Ring gold tip 1 mm	
VCF403200T	80 mm
VCF403300T	110 mm
Upward	
VCF403400T	80 mm
VCF403500T	110 mm
Downward	

Alligator Forceps



Otology

Micro Cup-Shaped Forceps and Micro Ear Forceps
 Mikro Löffelzangen und Mikro-Ohrzangen
 Micro-Pinzas con boca en forma de
 Cucharilla y Micro-pinza auriculares

اوتولوژی
پانچ ها



CE

SQS Certificate
 ISO 9001:2000
 ISO 13485:2003

479



Otology
Micro Ear Scissors
Mikro Ohrscheren
Micro-tijeras auriculares

اتولوژی
شنوایی
قیچی ها

ایزاد
دندان

CE

SQS Certificate
ISO 9001:2000
ISO 13485:2003

480

	VCF404000	Straight		
	VCF404100	Straight, black finish	80 mm	
	VCF404200	Straight		
	VCF404300	Straight, black finish	110 mm 4.0 x 0.6 mm	
	VCF404500	Straight		
	VCF404600	Straight, black finish	80 mm	
	VCF404700	Straight		
	VCF404800	Straight, black finish	110 mm	
	VCF405000	Curved up		
	VCF405100	Curved up, black finish	80 mm	
	VCF405200	Curved up		
	VCF405300	Curved up, black finish	110 mm	
	VCF405500	Right		
	VCF405600	Right, black finish	80 mm	
	VCF405700	Right		
	VCF405800	Right, black finish	110 mm	
	VCF406000	Left		
	VCF406100	Left, black finish	80 mm	
	VCF406200	Left		
	VCF406300	Left, black finish	110 mm	
	VCF406500	Straight		
	VCF406600	Straight, black finish	80 mm	
	VCF406700	Straight		
	VCF406800	Straight, black finish	110 mm	
	VCF407000	Curved up		
	VCF407100	Curved up, black finish	80 mm	
	VCF407200	Curved up		
	VCF407300	Curved up, black finish	110 mm	
	VCF407500	Right		
	VCF407600	Right, black finish	80 mm	
	VCF407700	Right		
	VCF407800	Right, black finish	110 mm	
	VCF408000	Left		
	VCF408100	Left, black finish	80 mm	
	VCF408200	Left		
	VCF408300	Left, black finish	110 mm	

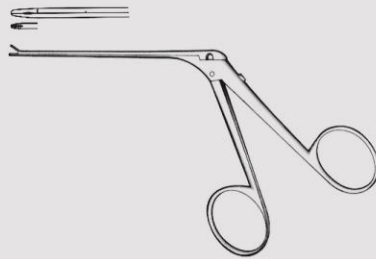
Bellucci
Very delicate

Wullstein



Otology

Wire Closure Forceps, Mastoid Ringers
Draktbijsangangen, Ohr-Knochenstanzen
Pinzas para doblar alambre, Pinzas cortantes para huesos



Greven
VCF408500

2 mm

3 mm



Citelli
VCF409000 2 mm
VCF409100 3 mm

2 mm



Beyer
VCF409500

1 mm



Beyer
VCF410100

اتولوژی
شنوایی
پنس ها
پانچ ها



CE

SQS Certificate
ISO 9001:2000
ISO 13485:2003

481



Rhinology
Nasal Specula
Nasenspekula
Especulos nasales

رینولوژی
اسپیکلوم ها



CE

SQS Certificate
ISO 9001:2000
ISO 13485:2003

482



VCG300100
Fig. 0

VCG300200
Fig. 1

VCG300300
Fig. 2



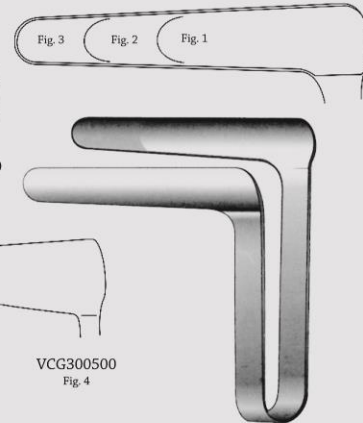
Goldsmith Thudichum



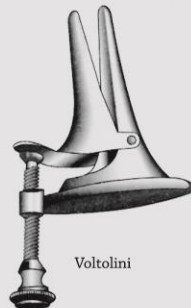
VCG300400
Fig. 3



VCG300500
Fig. 4



St. Clair Thomson
VCG301000 Fig. 1, 35 mm
VCG301100 Fig. 2, 50 mm
VCG301200 Fig. 3, 75 mm



Voltolini



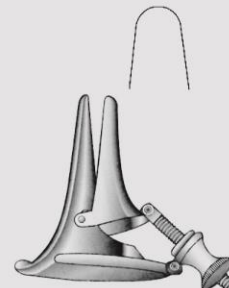
VCG301500
Fig. 1



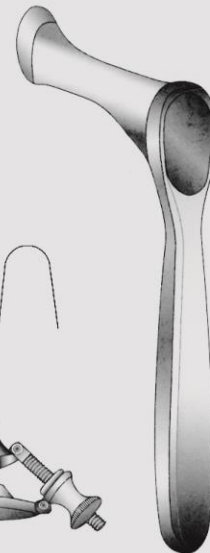
VCG301600
Fig. 2



VCG301700
Fig. 3



Vacher
VCG302000



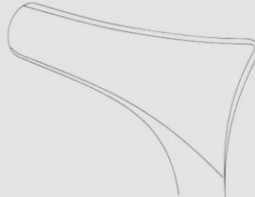
Yankauer
VCG302519
19 cm / 7 1/2"



Rhinology
Nasal Specula
Nasenspekula
Especulos nasales



Hartmann
16.5 cm / 6 1/2"



VCG303016
Fig. 1



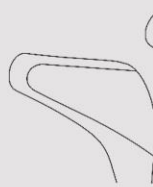
VCG303116
Fig. 2



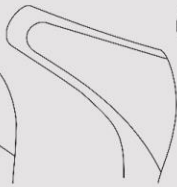
VCG303216
Fig. 3



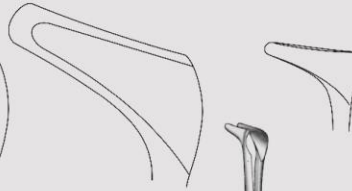
Hartmann-Halle
15 cm / 6"



VCG303515
Fig. 1



VCG303615
Fig. 2



VCG303715
Fig. 3



VCG304013
13 cm / 5"

رینولوژی
اسپیکلوم ها



CE

SQS Certificate
ISO 9001:2000
ISO 13485:2003

483



Rhinology
Nasal Specula
Nasenspekula
Especulos nasales

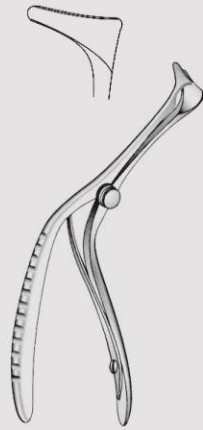
رینولوژی
اسپیکلوم ها



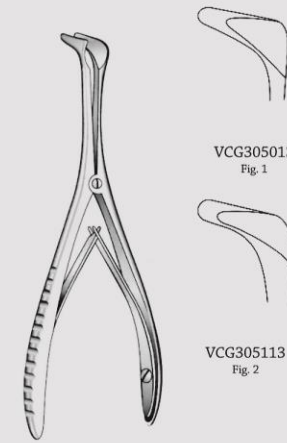
CE

SQS Certificate
ISO 9001:2000
ISO 13485:2003

484



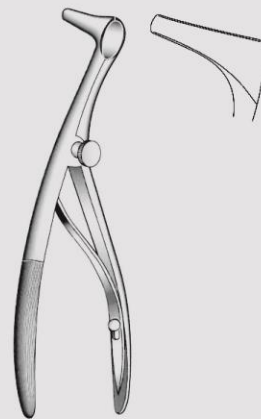
VCG304513
13 cm / 5"



Tieck-Halle
13.5 cm / 5 1/4"

VCG305013
Fig. 1

VCG305113
Fig. 2



Beckman
VCG305515
15 cm / 6"



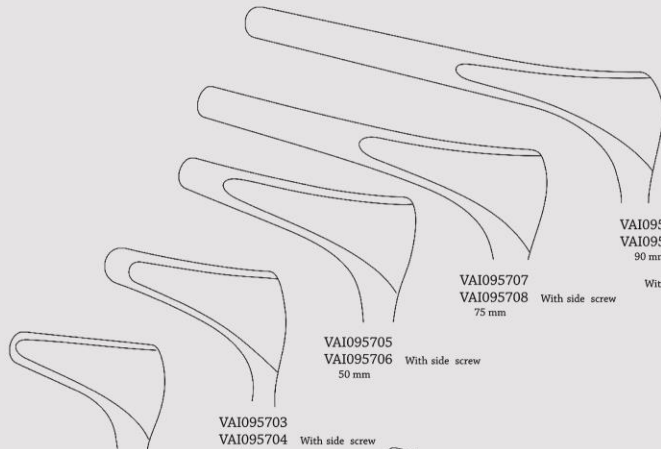
Vienna
VCG306014 Infant
VCG306114 Child
VCG306214 Adult
VCG306314 Sheet
VCG306414 Metal
14.5 cm / 5 3/4"



Rhinology
 Nasal Specula
 Nasenspekula
 Especulos nasales



Killian
 13 cm / 5"



VAI095701
 VAI095702 With side screw
 35 mm

VAI095703
 VAI095704 With side screw
 40 mm

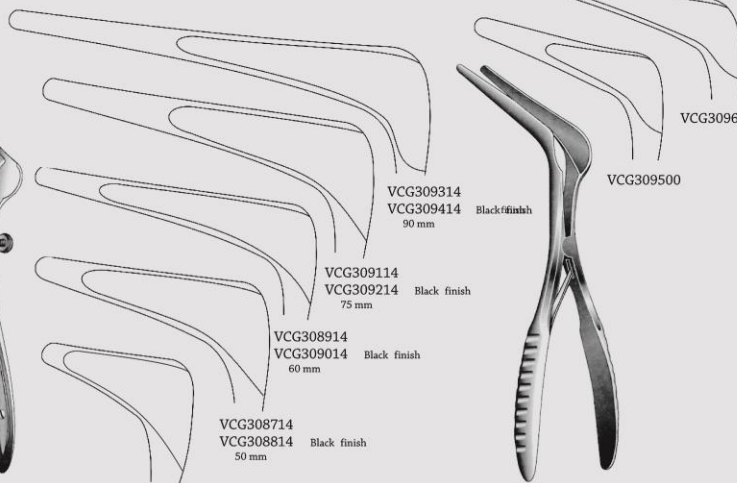
VAI095705
 VAI095706 With side screw
 50 mm

VAI095707
 VAI095708 With side screw
 75 mm

VAI095709
 VAI095710 With side screw
 90 mm



Cottle
 14 cm / 5 1/2"
 Extra thin blades



VCG308514
 VCG308614 Black finish
 35 mm

VCG308714
 VCG308814 Black finish
 50 mm

VCG308914
 VCG309014 Black finish
 60 mm

VCG309114
 VCG309214 Black finish
 75 mm

VCG309314
 VCG309414 Black finish
 90 mm

VCG309500

VCG309600

Dull black chrome plated



CE

SQS Certificate
 ISO 9001:2000
 ISO 13485:2003





Rhinology
Nasal Specula
Nasenspekula
Especulos nasales

رینولوژی
اسپکلوم ها



CE

SQS Certificate
ISO 9001:2000
ISO 13485:2003

486



Tossier
17 cm / 6 3/4"
For dilation, black chromium plated



VCG310117
70 x 8.5 mm blade
For adults



VCG310217
80 x 8.5 mm blade
For adults



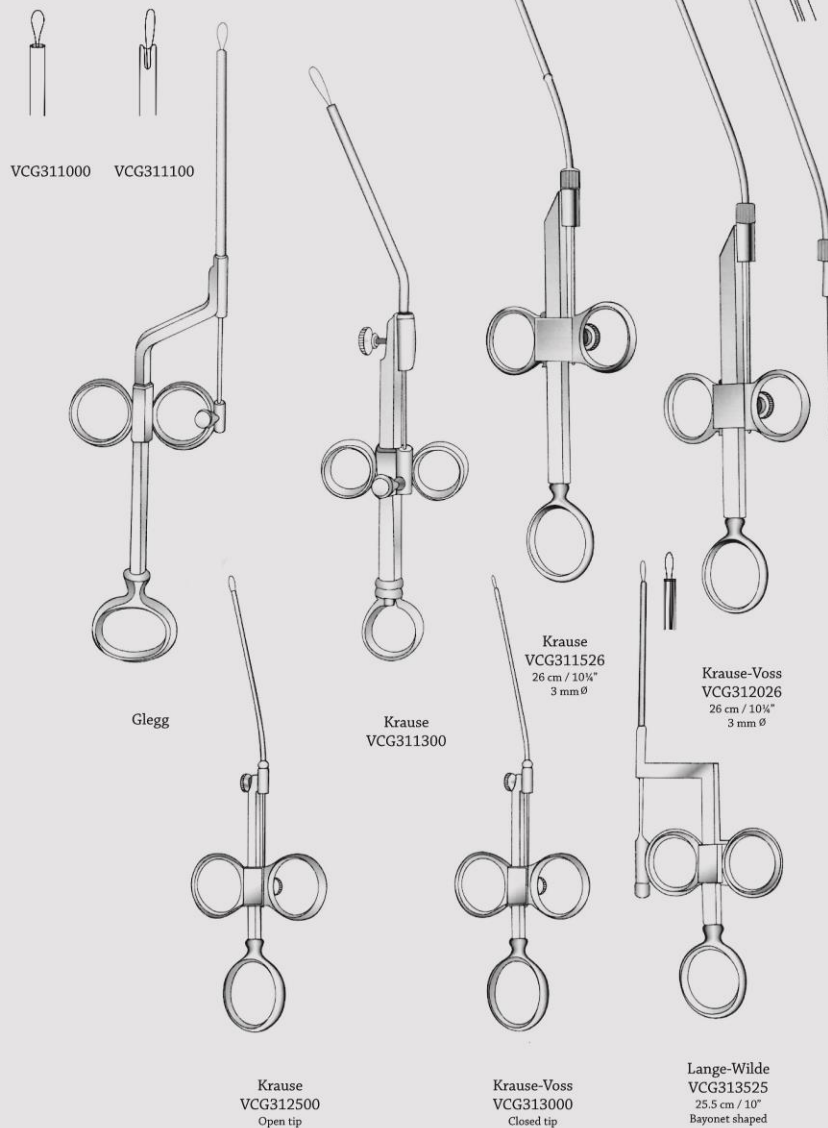
VCG310317
60 x 7.0 mm blade
For children



VCG310417
70 x 7.0 mm blade
For children



Rhinology
 Polypus Snares
 Polypenschnurer
 Polipotomos



رینولوژی



CE

SQS Certificate
 ISO 9001:2000
 ISO 13485:2003





Rhinology

Ear Forceps, Nasal Tampon Forceps
Ohrpinzetten, Nasentamponpinzetten
Pinzas auriculares, Pinzas para tamponamiento

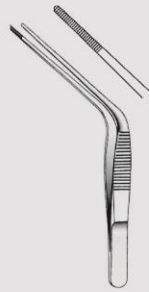
رینولوژی
پنست ها



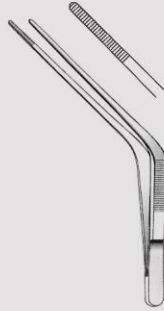
CE

SQS Certificate
ISO 9001:2000
ISO 13485:2003

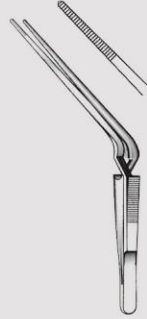
488



Troeltsch (wilde)
VCG314011
11 cm / 4 1/4"



Troeltsch (wilde)
VCG314512
12 cm / 4 3/4"



Troeltsch (wilde)
VCG315013
13 cm / 5"



Lucae
VCG315514
VCG315614 1:2 Teeth
14 cm / 5 1/2"



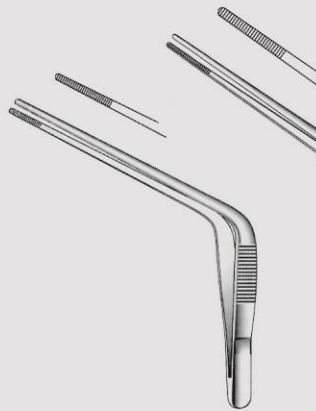
Jansen
VCG316016 16 cm / 6 1/4"
VCG316020 20 cm / 8"



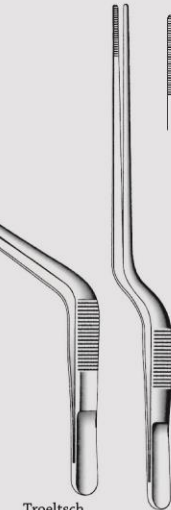
VCG316500 0.3 mm Ø
VCG316600 0.4 mm Ø
Snare wire



VCG317010 0.2 mm Ø
VCG317110 0.3 mm Ø
10.5 cm / 4"
Snare wire
12 pieces



Troeltsch
VCG317515
15 cm / 6"

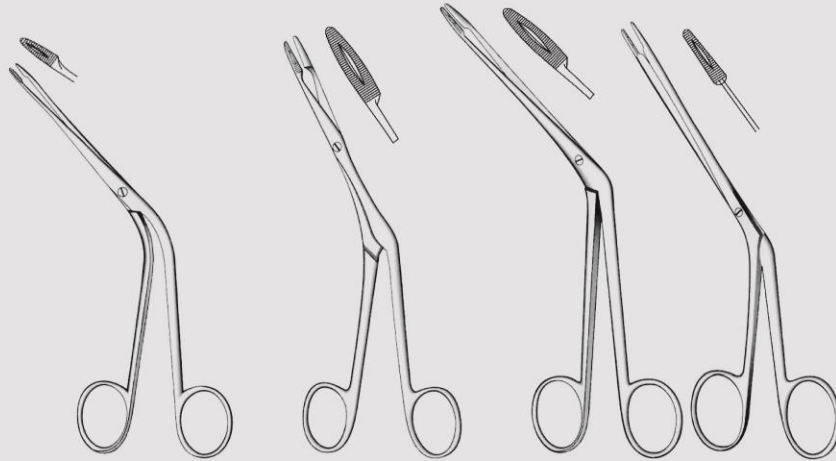


Troeltsch
VCG318018 18 cm / 7"
Gruenwald
(Jansen)
VCG318516 16 cm / 6 1/4"
VCG318520 20 cm / 8"



Rhinology

Nasal Polypus and Septum Compression Forceps
Polypenzangen, Septumzange
Pinzas para Polipos, Pinza para el tabique nasal

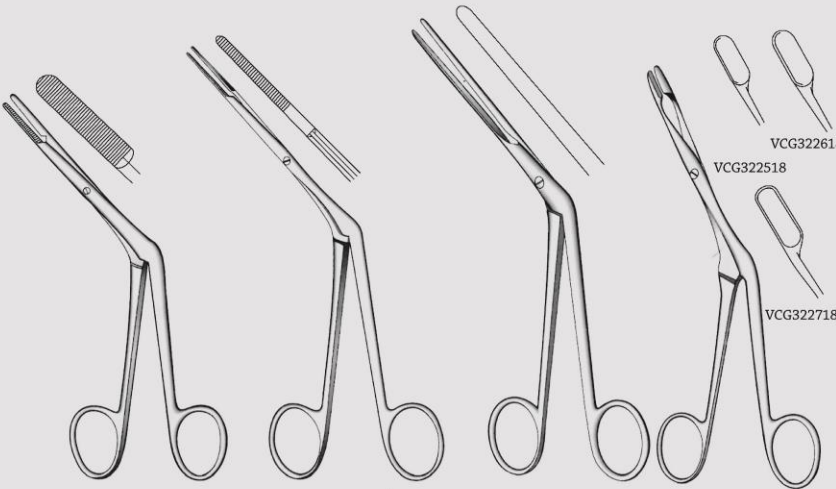


Hartmann
VCG319016
16 cm / 6 1/4"

Heymann-Knight
VCG319518
18 cm / 7"

Hartmann
VCG320120
20 cm / 8"

Littauer
VCG320518
18 cm / 7"



Killian
VCG321017
17 cm / 6 3/4"

Westmacott
VCG321520
20 cm / 8"

Lubet-Barbon
VCG322020
20 cm / 8"
Nasal tampon forceps

Heymann
18 cm / 7"

VCG322618
VCG322518

VCG322718

رینولوژی
پنس ها



CE

SQS Certificate
ISO 9001:2000
ISO 13485:2003

489



Rhinology

Septum Forceps, Ethmoid Bone Forceps
Septumzangen, Siebbeinzangen
Pinzas para tabique nasal, Pinzas para etmoides

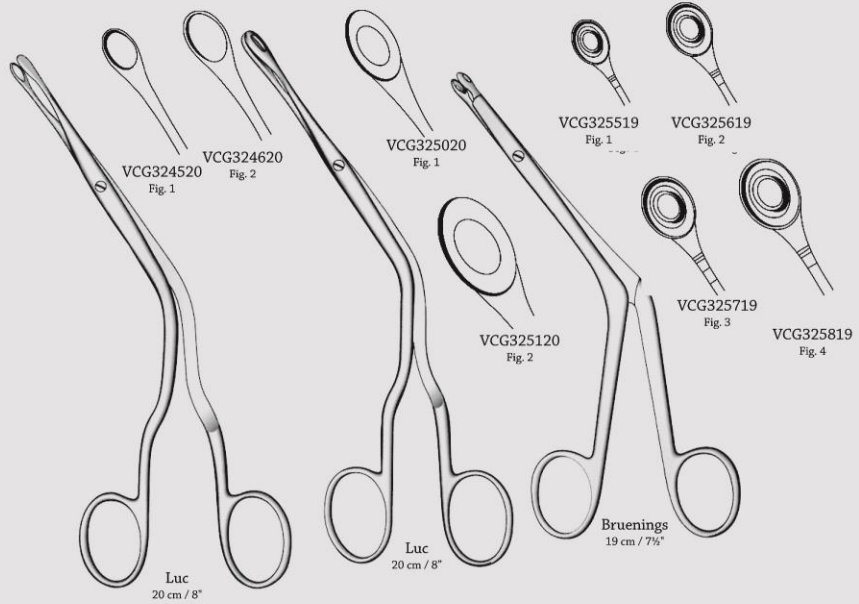
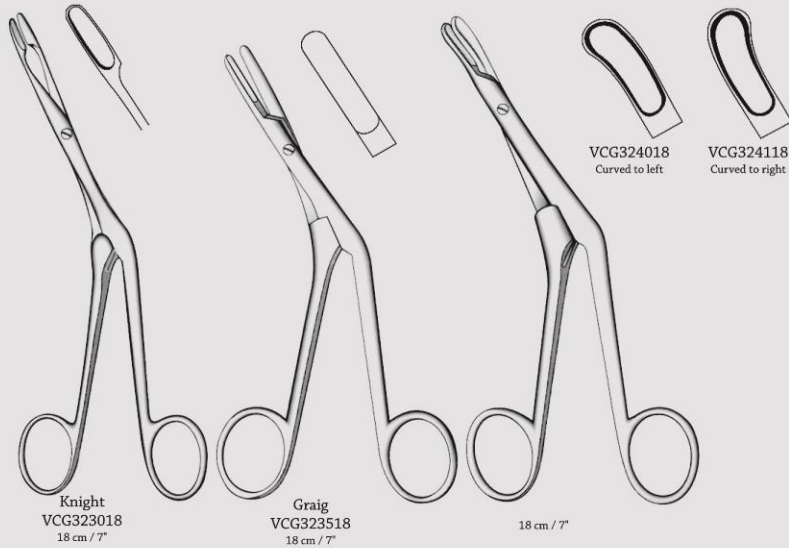
رینولوژی
پنس ها



CE

SQS Certificate
ISO 9001:2000
ISO 13485:2003

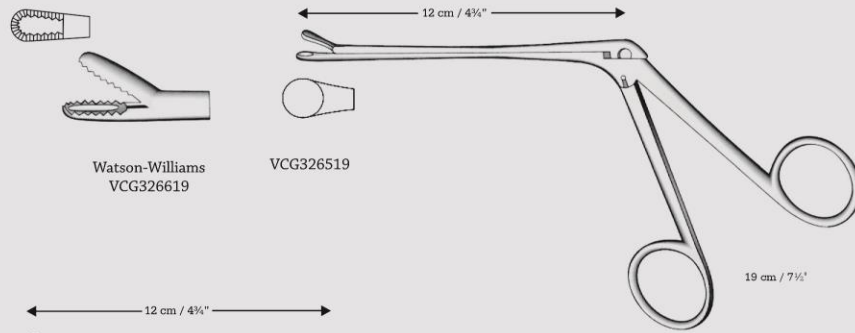
490





Rhinology

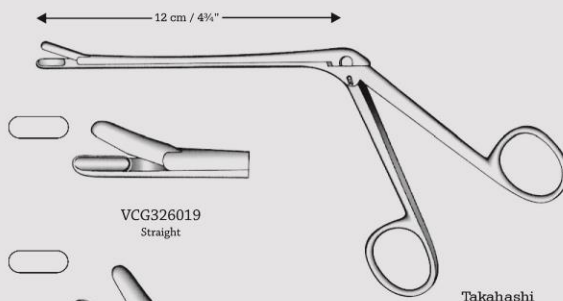
Ethmoid Bone Forceps, Nasal Cutting Forceps
Siebbeinzangen, Scharfe Nasenzangen
Pinzas para etmoides, Pinzas nasales cortantes



Watson-Williams
VCG326619

VCG326519

19 cm / 7 1/2"

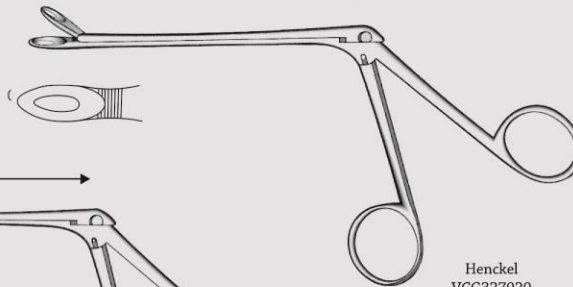


VCG326019
Straight

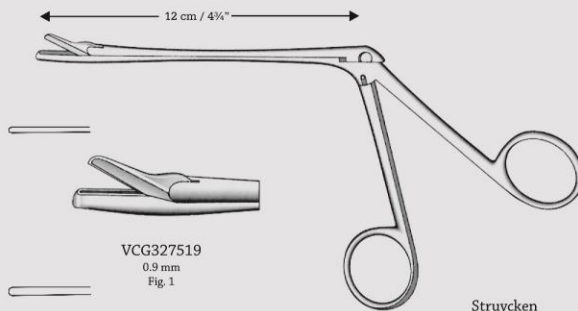
Takahashi
19 cm / 7 1/2"



VCG326119
Upward

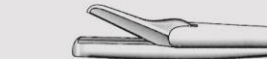


Henckel
VCG327020
20 cm / 8"



VCG327519
0.9 mm
Fig. 1

Struycken
19 cm / 7 1/2"



VCG327619
1.2 mm
Fig. 2

رینولوژی
پنس ها



CE

SQS Certificate
ISO 9001:2000
ISO 13485:2003

491



Rhinology

Nasal Cutting Forceps, Ethmoid Bone Forceps
Scharfe Nasenzangen, Siebbeinzangen
Pinzas nasales cortantes, Pinzas para etmoides

رینولوژی
پانچ ها



CE

SQS Certificate
ISO 9001:2000
ISO 13485:2003

492



Straight



Fig.1
VCG328019
VCG329019
Through cut
3.0 mm



Fig.2
VCG328119
VCG329119
Through cut
3.5 mm



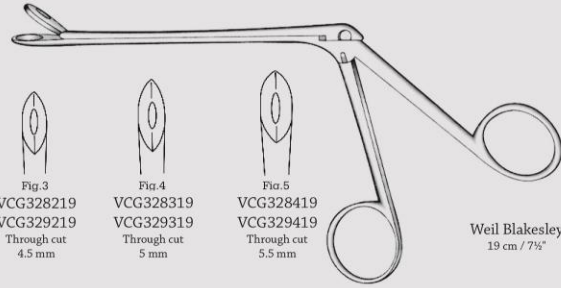
Fig.3
VCG328219
VCG329219
Through cut
4.5 mm



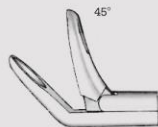
Fig.4
VCG328319
VCG329319
Through cut
5 mm



Fig.5
VCG328419
VCG329419
Through cut
5.5 mm



Weil Blakesley
19 cm / 7 1/2"



45°



Fig.1
VCG330012
Jaw width
VCG331012
Through cut
3.0 mm



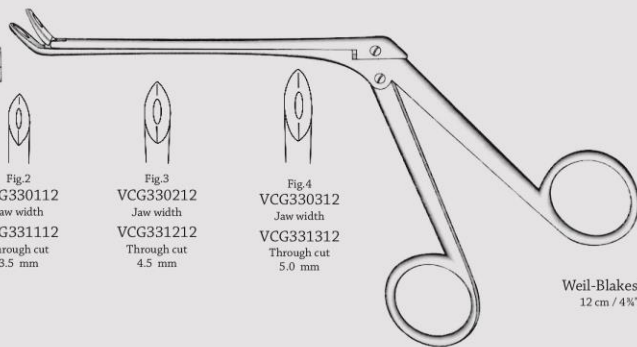
Fig.2
VCG330112
Jaw width
VCG331112
Through cut
3.5 mm



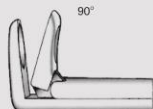
Fig.3
VCG330212
Jaw width
VCG331212
Through cut
4.5 mm



Fig.4
VCG330312
Jaw width
VCG331312
Through cut
5.0 mm



Weil-Blakesley
12 cm / 4 3/4"



90°



Fig.1
VCG331512
3.0 mm



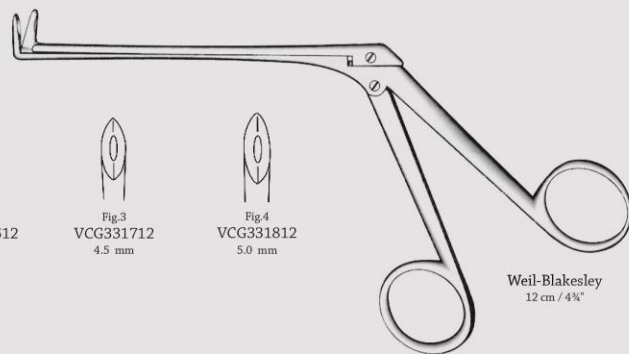
Fig.2
VCG331612
3.5 mm



Fig.3
VCG331712
4.5 mm



Fig.4
VCG331812
5.0 mm



Weil-Blakesley
12 cm / 4 3/4"



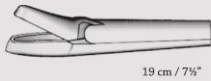
Rhinology
 Nasal Cutting Forceps
 Scharfe Nasenzangen
 Pinzas nasales cortantes

VCG332019
 2.2 mm

VCG332119
 2.6 mm

VCG332219
 3.0 mm

VCG332319
 3.4 mm



19 cm / 7 1/2"

VCG332519

VCG332619

VCG332719



Myles
 19 cm / 7 1/2"
 Shaft 12 cm

VCG333019
 5 mm

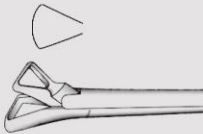
VCG333119
 7 mm

VCG333219
 9 mm

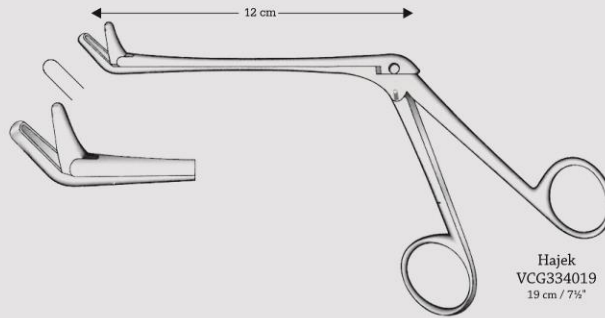
VCG333319
 11 mm



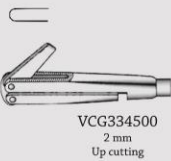
Hartmann
 19 cm / 7 1/2"
 Shaft 12 cm



Schmeden
 VCG333519
 19 cm / 7 1/2"
 Shaft 12 cm



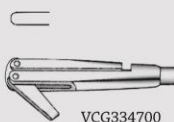
Hajek
 VCG334019
 19 cm / 7 1/2"



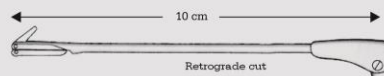
VCG334500
 2 mm
 Up cutting



VCG334600
 2 mm
 Right cutting



VCG334700
 2 mm
 Left cutting



Stamberger
 Antrum punch

رینولوژی
 پنچ ها



CE

SQS Certificate
 ISO 9001:2000
 ISO 13485:2003

493



Rhinology
Septum Forceps and Septum Scissors
Septumzangen und Septumscheren
Pinza para tabique nasal Y Tijeras

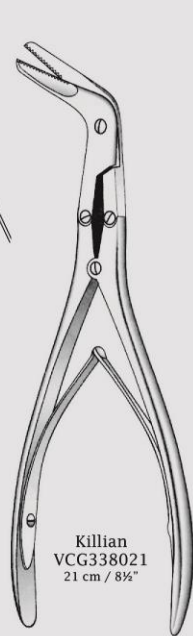
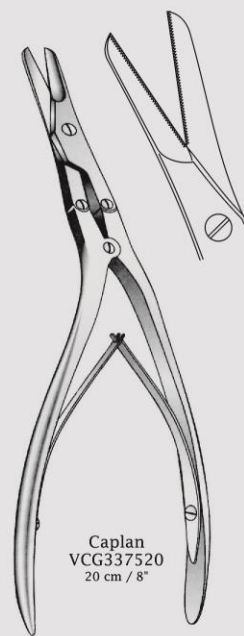
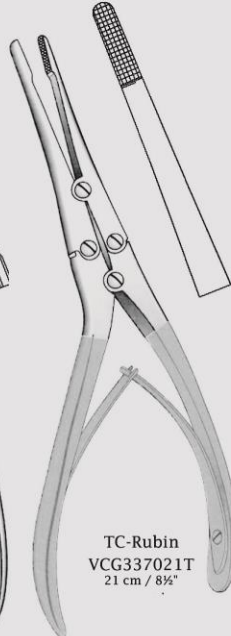
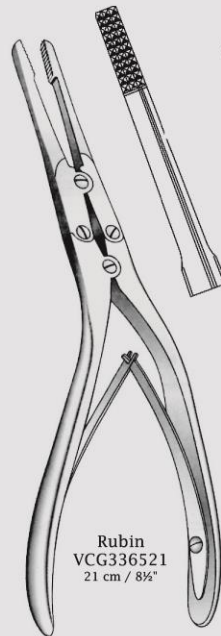
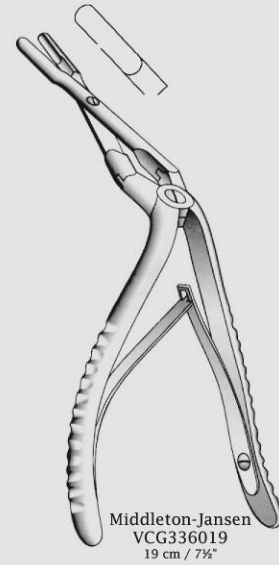
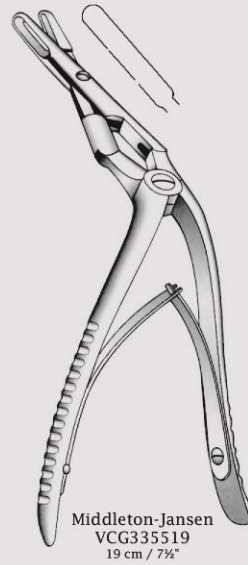
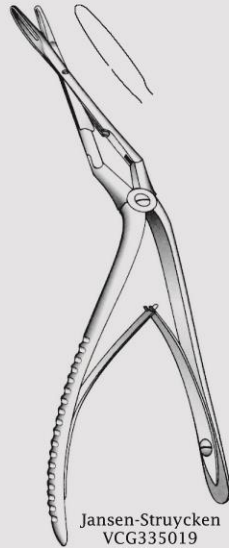
رینولوژی
قیچی ها
پنس های سپتوم



CE
SQS Certificate
ISO 9001:2000
ISO 13485:2003

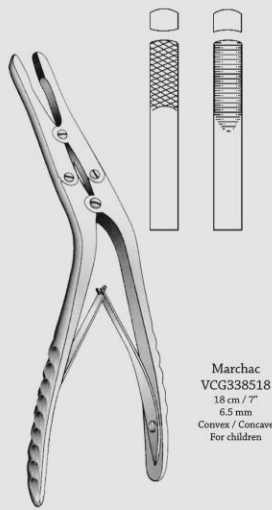
494

Instruments with Tungsten Carbide Inserts
Tc Gold

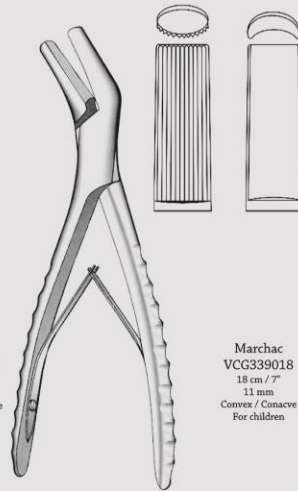




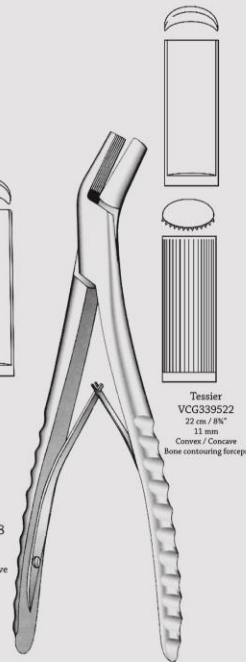
Rhinology
Bone Contouring Forceps
Knochenformzangen
Pinzas para formar huesos



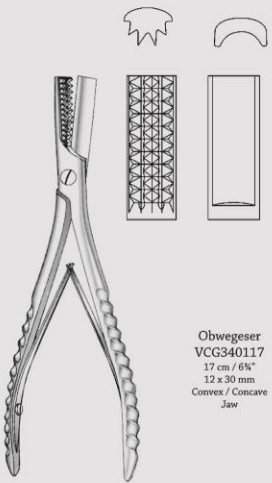
Marchac
VCG338518
18 cm / 7"
6.5 mm
Convex / Concave
For children



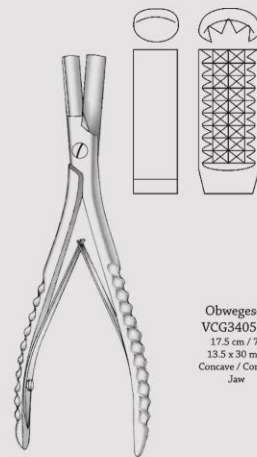
Marchac
VCG339018
18 cm / 7"
11 mm
Convex / Concave
For children



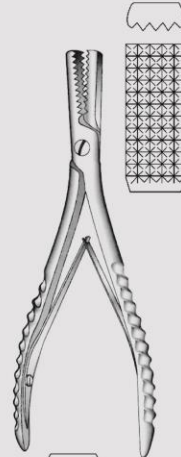
Tessier
VCG39522
22 cm / 8 1/2"
11 mm
Convex / Concave
Bone contouring forceps



Obwegeser
VCG340117
17 cm / 6 3/4"
12 x 30 mm
Convex / Concave
Jaw



Obwegeser
VCG340517
17.5 cm / 7"
13.5 x 30 mm
Concave / Convex
Jaw



Obwegeser
VCG341017
17.5 cm / 7"
13.5 x 30 mm
Flat / Flat
Jaw



SQS Certificate
ISO 9001:2000
ISO 13485:2003

495



Rhinology
Sphenoid Bone Punches
Keilbeinstanzen
Pinzas sacabocadas para esfenoidal

رینولوژی
پانچ ها



CE

SQS Certificate
ISO 9001:2000
ISO 13485:2003

496



4 x 4 mm³
Hajek
VCG341500
Upward cutting



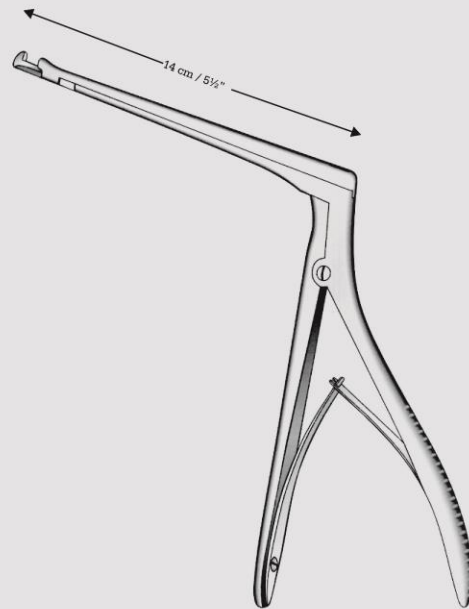
4 x 4 mm
Hajek
VCG341600
Downward cutting



3.5 x 3.5 mm
Hajek-Kofler
VCG341700
Upward cutting



3.5 x 3.5 mm
Hajek-Kofler
VCG341800
Downward cutting





Rhinology

Rongeur Forceps and Antrum Punches Forceps
Meißelzangen, Kieferhakenstangen
Pinzas gubias, Pinzas sacabocas para seno maxilar



- VCG342000 2 x 10 mm
- VCG342100 3 x 10 mm
- VCG342200 4 x 10 mm
- VCG342300 5 x 10 mm
- VCG342400 6 x 10 mm
Curved up

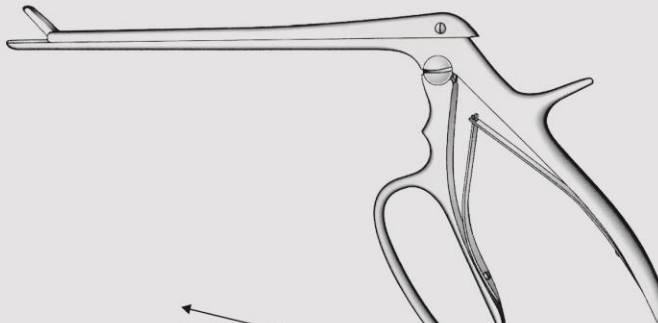


- VCG343000 2 x 10 mm
- VCG343100 3 x 10 mm
- VCG343200 4 x 10 mm
- VCG343300 5 x 10 mm
- VCG343400 6 x 10 mm
Straight



- VCG344000 2 x 10 mm
- VCG344100 3 x 10 mm
- VCG344200 4 x 10 mm
- VCG344300 5 x 10 mm
- VCG344400 6 x 10 mm
Curved down

18 cm / 7"



Ferris-Smith-Cushing



- 4 mm VCG345020
4 x 4 mm
- 5 mm VCG345120
5 x 5 mm
- 6 mm VCG345220
6 x 6 mm



Kerrison
20 cm / 8"
Upward cutting

رینولوژی
پتیتوری
ها
پانچ
ها



CE

SQS Certificate
ISO 9001:2000
ISO 13485:2003

497



Rhinology

Rhinoplastic and Nasal Knives
 Nasenplastik- und Operationsmesser
 Bisturries para plastica Y operaciones de la nariz

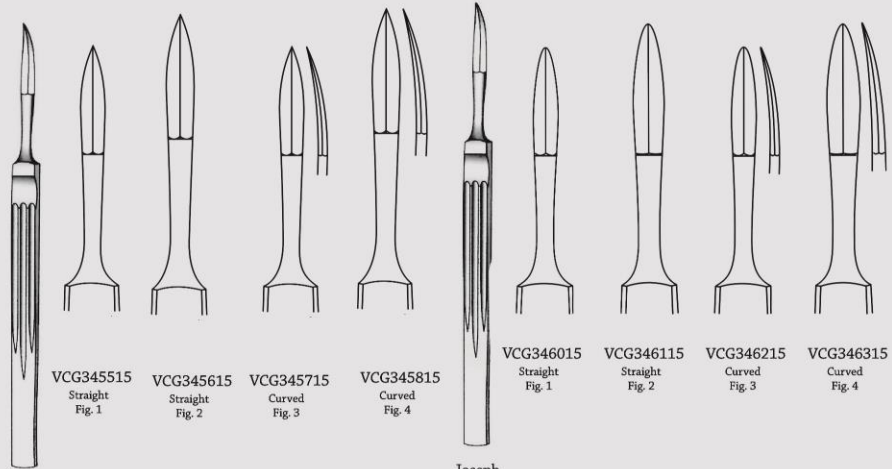
رینولوژی
 چاقوها



CE

SQS Certificate
 ISO 9001:2000
 ISO 13485:2003

498



VCG345515
 Straight
 Fig. 1

VCG345615
 Straight
 Fig. 2

VCG345715
 Curved
 Fig. 3

VCG345815
 Curved
 Fig. 4

VCG346015
 Straight
 Fig. 1

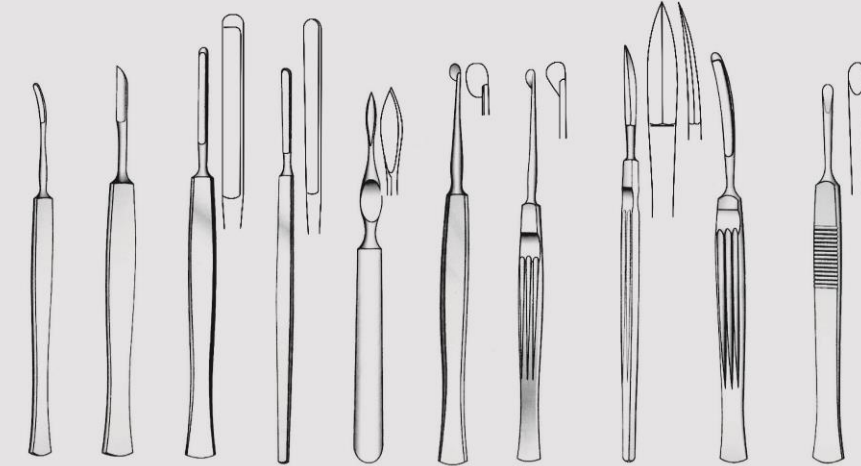
VCG346115
 Straight
 Fig. 2

VCG346215
 Curved
 Fig. 3

VCG346315
 Curved
 Fig. 4

Joseph
 15 cm / 6"
 Sharp

Joseph
 15 cm / 6"
 Blunt



Heymann
 VCG346500

Krieg
 VCG347000

Joseph
 VCG347515
 15 cm / 6"
 Straight

Cottle
 VCG348000

Ballenger
 VCG348500

Freer
 VCG349000

Freer
 VCG349500
 Mucosa knife

Fomon
 VCG350116
 16.5 cm / 6 1/2"

Converse
 VCG350516
 16 cm / 6 1/4"

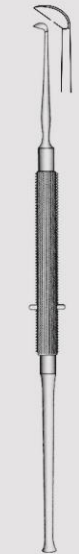
Cottle
 VCG351014
 14 cm / 5 1/2"

Curved blade 4 x 35 mm,
 with button end bistouri



Rhinology

Septum Knife/Septum Elevator and Raspatories
 Septummesser/Septum-Elevator und Raspatorien
 Retortorio para el labio nasal Elevador para el labio nasal T.Legras



Freer
VCG351500



Freer
VCG352000



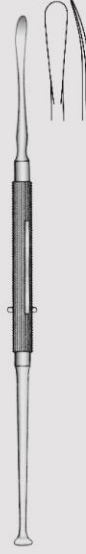
Freer
VCG352519
19 cm / 7½"



Freer
VCG353019
19 cm / 7½"



Freer
VCG353519
19 cm / 7½"
Sharp
5 mm



Freer
VCG354019
19 cm / 7½"
Blunt
6 mm



Freer
VCG354516 16 cm / 6¼"
VCG354519 19 cm / 7½"
Sharp / Blunt
5/5 mm



Durham
VCG355000



Howarth
VCG356000



Hill
VCG356500



Freer
VCG357018 19.5 cm / 7¾"
VCG357022 22 cm / 8¾"
Blunt / Sharp
Square handle



CE

SQS Certificate
 ISO 9001:2000
 ISO 13485:2003

499



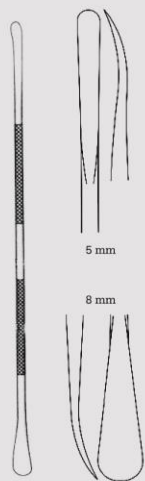
Oral Maxillo-Facial Surgery
Elevators, Graft Packers
Elevatoren, Transplantatstopfer
Elevadores, Atacadores de trasplantes

فک و صورت
پریوست الویتورها



CE
SQS Certificate
ISO 9001:2000
ISO 13485:2003

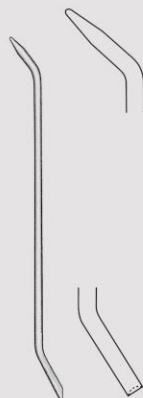
500



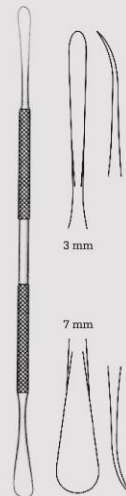
Terry
VCG357517
17 cm / 6 3/4"
For elevation of alveolar flaps



Terry
VCG358011
11 cm / 4 1/4"
Graft packer



VCG358513
13 cm / 5"
Graft packer



Terry
VCG359018
18 cm / 7"
For subperiosteal tunnels



Obwegeser
VCG359520
20.5 cm / 8"



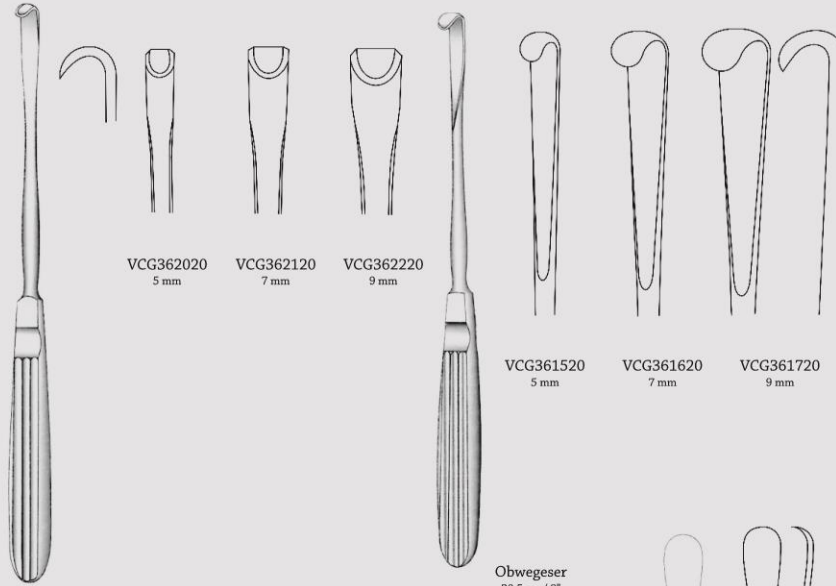
Obwegeser
VCG360120
20.5 cm / 8"



VCG360500
2 mm
Sharp point



Rhinology
Periosteal Elevators
Raspatorien
Legras



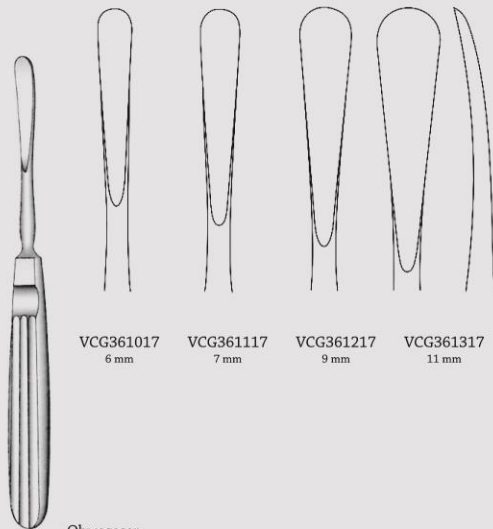
VCG362020 5 mm
VCG362120 7 mm
VCG362220 9 mm

VCG361520 5 mm
VCG361620 7 mm
VCG361720 9 mm

Obwegeser
20.5 cm / 8"

Obwegeser
20.5 cm / 8"

رینولوژی
پریوست الویتورها



VCG361017 6 mm
VCG361117 7 mm
VCG361217 9 mm
VCG361317 11 mm

Obwegeser
17.5 cm / 7"

Lane Periosteal Elevator
VCG363019 Narrow tip sharp
VCG363119 Wide tip sharp
VCG363219 Narrow tip blunt
VCG363319 Wide tip blunt
19 cm / 7 1/2"



CE

SQS Certificate
ISO 9001:2000
ISO 13485:2003

501



Rhinology

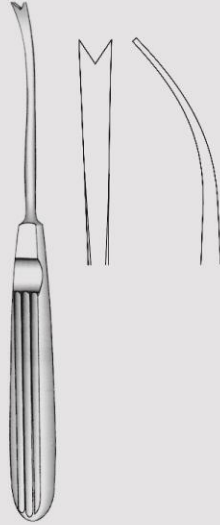
Periosteal Elevators, Swallowtail Raspatories
Raspatorien, Schwabenschwanz-Raspatorien
Legras, Legras en forma de cola de milano

رینولوژی
پریوست الویتورها



SQS Certificate
ISO 9001:2000
ISO 13485:2003

502



Steinhauser
VCG363518
18 cm / 7"
Reposition instrument

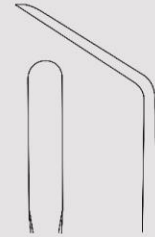


VCG364016
16 cm / 6 1/4"
6 x 12 mm

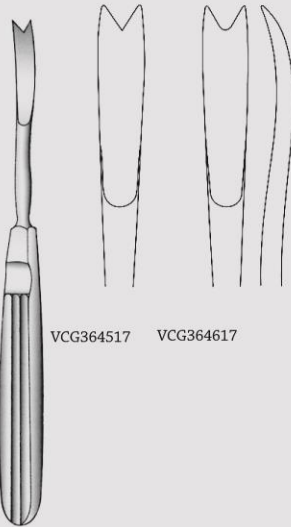
Steinhauser



VCG364116
16.5 cm / 6 1/2"
6 x 19 mm

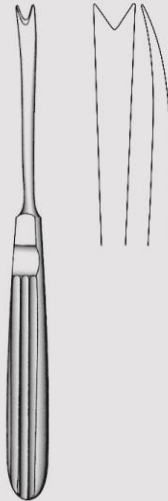


VCG364217
17 cm / 6 3/4"
6 x 26 mm

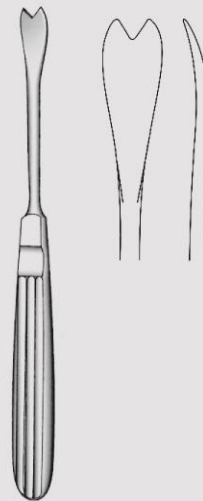


VCG364517 VCG364617

Obwegeser
17.5 cm / 7"



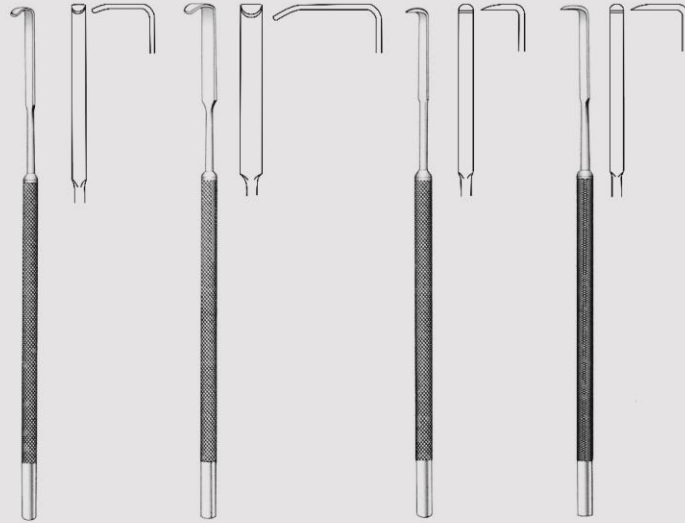
Obwegeser
VCG365017
17.5 cm / 7"
7.5 mm



Obwegeser
VCG365517
17.5 cm / 7"
11 mm



Rhinology
Cleft Palate Instruments
Gaumenspalten Instrumente
Instrumentos paladares



Salyer
VCG366018
18.5 cm / 7 1/4"
Cleft palate hooklet
Short blade

Salyer
VCG366518
18.5 cm / 7 1/4"
Cleft palate hooklet
Long blade

Salyer
VCG367018
18 cm / 7"
Cleft palate dissector
Nasal

Salyer
VCG367518
18 cm / 7"
Cleft palate dissector
Nasal



Salyer
VCG368018
18 cm / 7"
Cleft palate instruments

Salyer
VCG368518
18 cm / 7"
Cleft palate elevator

Salyer
VCG369018
18 cm / 7"
Cleft palate elevator

Jaboma
VCG369517
17 cm / 6 3/4"
Cleft palate periosteal elevator



SQS Certificate
ISO 9001:2000
ISO 13485:2003

503



Rhinology
Periosteal Elevators
Raspatorien
Legras

رینولوژی
پریوست الویتور



CE

SQS Certificate
ISO 9001:2000
ISO 13485:2003

504



Obwegeser
18 cm / 7"
Angled cutting

VCG370118
6 mm



VCG370218
7 mm



VCG370318
9 mm



VCG370418
11 mm

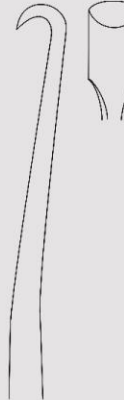


Hargis
23 cm / 9"

VCG371023
6.5 mm
Right



VCG371123
9 mm
Right



VCG371223
6.5 mm
Left



VCG371323
9 mm
Left





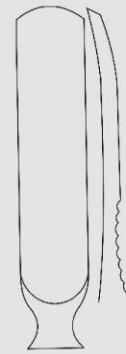
Rhinology
Periosteal Elevators
Raspatorien
Legras para periostio



Marchac
15.5 cm / 6"



VCG371515
7.5 mm



VCG371615
12 mm



Marchac
17 cm / 6 3/4"



VCG372017
2 mm



VCG372117
3.5 mm



VCG372217
5 mm

رینولوژی
پریوست الویتورها



CE

SQS Certificate
ISO 9001:2000
ISO 13485:2003

505



Rhinology

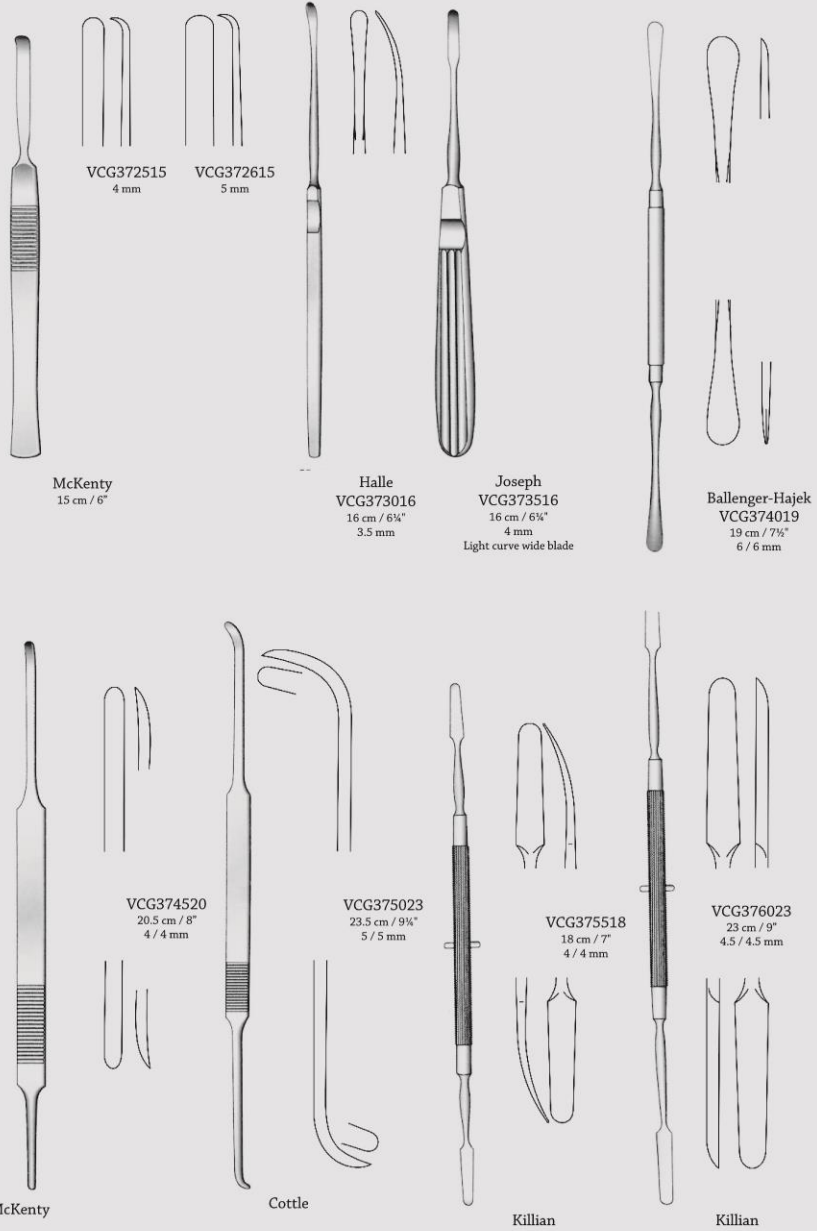
Septum Elevators
Septumelevatorien
Elevadores para tabique nasal

رینولوژی
پریوست الویتورها



SQS Certificate
ISO 9001:2000
ISO 13485:2003

506





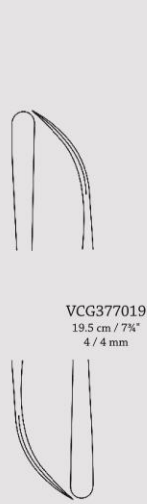
Rhinology

Septum Elevators,
Periosteal Elevators
Septumelevarioren,
Periostelevatoriön
Elevadores para tabique nasal,
Legras para periostio



VCG376521
21.5 cm / 8 1/2"
4 / 4 mm

Pennington



VCG377019
19.5 cm / 7 3/4"
4 / 4 mm

Roger



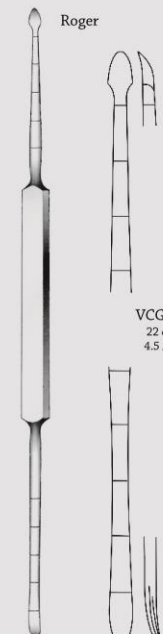
VCG377521
21.5 cm / 8 1/2"
4 mm

Joseph-Masing



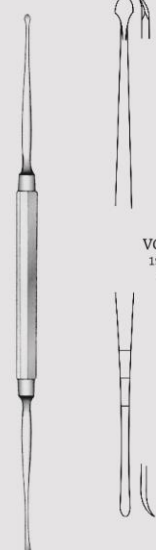
VCG378023
23 cm / 9"
3.3 / 3.7 mm

Cottle



VCG378522
22 cm / 8 3/4"
4.5 / 4.5 mm

Cottle



VCG379019
19.5 cm / 7 3/4"
3 / 2 mm

Masing



CE

SQS Certificate
ISO 9001:2000
ISO 13485:2003

507



Rhinology

Swivel Knives, Septum Gouges / Chisels, Nasal Saws
Schwingmesser, Septum-Hohlmeißel / Meißel, Nasensagen
Cuchillos, Gubias / Circeles para tabique nasal, Sierras nasales

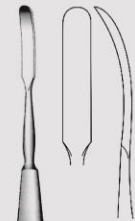
رینولوژی



CE

SQS Certificate
ISO 9001:2000
ISO 13485:2003

508



VCG379518
18 cm / 7"
6.5 mm

Joseph



Ballenger
21 cm / 8 1/4"
Straight



VCG380120
VCG380520
3 mm



VCG380220
VCG380620
4 mm



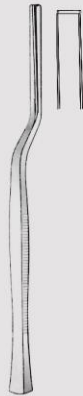
VCG380320 Straight
VCG380720 Angled
5 mm



Ballenger
20 cm / 8"
Angled



Ballenger
VCG381000
15 cm / 6"



Killian
VCG381500
16 cm / 6 1/4"
5 mm



Killian-Claus
VCG382000
16 cm / 6 1/4"
5 mm



Freer
VCG382518
18 cm / 7"



Freer
VCG383018
18 cm / 7"



Joseph
19 cm / 7 5/8"
Working length 40 mm



VCG383519

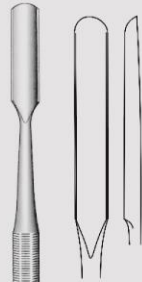


VCG383619



Rhinology

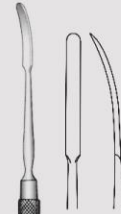
Septum Gouges &
Periosteal Elevators, Nasal Saws
Septum-Hohmeißel und
Raspatorien, Nasensagen
Gubias para tabique nasal Y Legras,
Sierras nasales



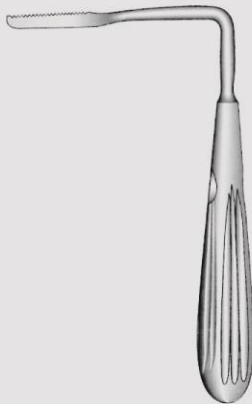
Freer
VCG384015
15 cm / 6"
6 mm
Septum gouges



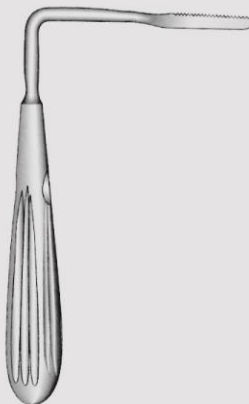
VCG384518
18 cm / 7"
3 x 18 mm



VCG385018
18 cm / 7"
3.5 x 23 mm



Joseph
VCG385500
Angled to left
Nasal knife
17 cm / 6 3/4"



Joseph
VCG386000
Angled to right
Nasal knife
17 cm / 6 3/4"

رینولوژی



CE

SQS Certificate
ISO 9001:2000
ISO 13485:2003

509



Rhinology
Periosteal Elevators
Periostraspatorien
Legras para periostio

رینولوژی
پریوست الویتورها



CE

SQS Certificate
ISO 9001:2000
ISO 13485:2003

510



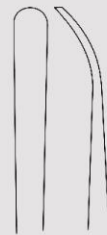
Tessier
20.5 cm / 8"



VCG386520
12 mm



VCG386620
15 mm



Tessier
VCG387018
18.5 cm / 7 1/4"
6 mm
Angled 30°



Tessier
VCG387518
18 cm / 7"
6 mm
Angled 60°



Rhinology

Nasal Hooks, Nasal Retractors,
Alar Hooklets
Nasenhaken, Nasenhaken,
Nasenflugelhaken
Ganchitos nasales, Separadores
nasales, Ganchitos para alas de nariz



Joseph
VCG388015
15 cm / 6"
Sharp



Cottle
VCG388516
16 cm / 6 1/4"
Sharp



Cottle
15 cm / 6"



VCG389015



VCG389115



VCG389215



Kilner
VCG389510
10 cm / 4"
Sharp



Converse
VCG390112
12 cm / 4 3/4"
Double ended
Sharp



Freer
VCG390515
15 cm / 6"
Sharp



VCG391516
2 mm



VCG391616
5 mm



VCG391716
7 mm



VCG391816
10 mm



Joseph
16 cm / 6 1/4"

رینولوژی
هوک ها



CE

SQS Certificate
ISO 9001:2000
ISO 13485:2003

511



Rhinology

Alar Hooklets, Retractors
Nasenflügelhaken, Wundhaken
Ganchitos para alas de nariz, Separadores

رینولوژی
هوک ها

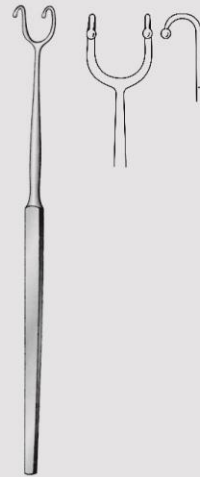


SQS Certificate
ISO 9001:2000
ISO 13485:2003

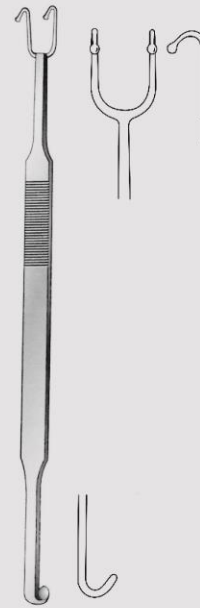
512



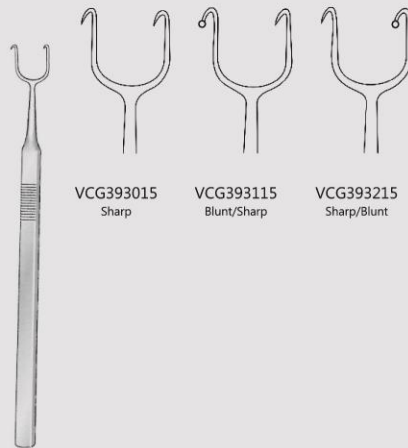
Weighted Nasal Hook
VCG394000
Approx. weight, 2oz
Nasal hook



Fomon
VCG392016
16 cm / 6 1/4"



Cottle-Neivert
VCG392520
20 cm / 8"

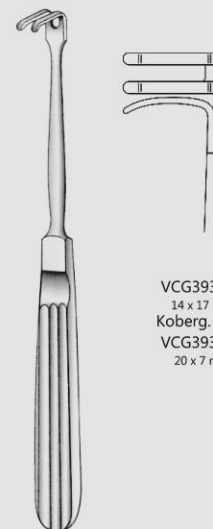


Cottle
15 cm / 6"

VCG393015
Sharp

VCG393115
Blunt/Sharp

VCG393215
Sharp/Blunt



18.5 cm / 7 1/4"

VCG393518
14 x 17 mm
Koberg. mod
VCG393618
20 x 7 mm



Rhinology

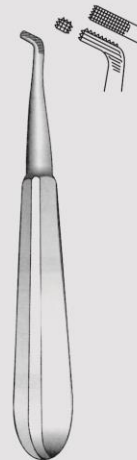
Wire Pushers, Arch Bar,
Zygoma Elevators
Drahtpositionierer, Drahtbogen,
Zygoma Elevatorien
Empujadores de alambres,
Arco de alambre, Elevadores
cigomaticos



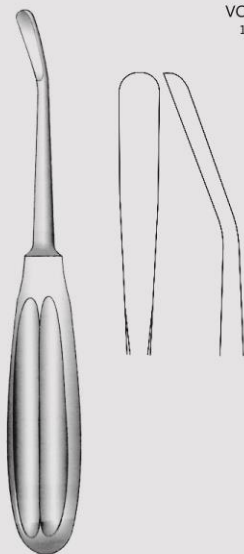
VCG394517
17 cm / 6 3/4"



Rowe
VCG395015
15 cm / 6"



Mershon
VCG395215
15 cm / 6"



Gillies
VCG395520
20 cm / 8"



Dingmann
VCG396021
21 cm / 8 1/4"
Tip 5.0 mm^Ø

رینولوژی



CE

SQS Certificate
ISO 9001:2000
ISO 13485:2003

513



Rhinology

Adenoid Curettes
Ringmesser
Cuchillos para Vegetaciones adenoides

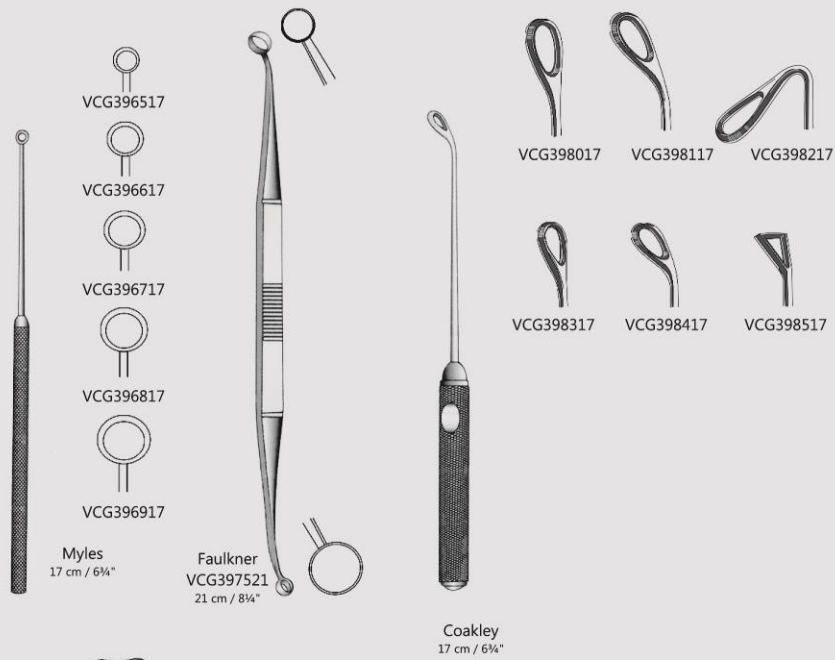
رینولوژی
کورت ها



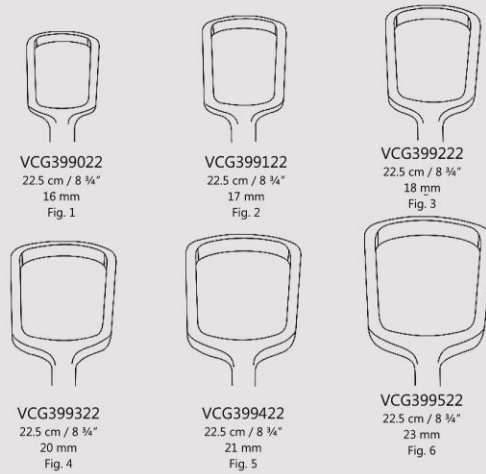
CE

SQS Certificate
ISO 9001:2000
ISO 13485:2003

514



Beckmann
22 cm / 8 3/4"
Trapezoidal fenestrated

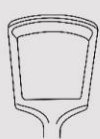




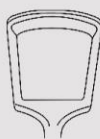
Rhinology
 Adenoid Currettes,
 Bone Currettes, Curette Sharpener
 Ringmesser,
 Scharfe Kuretten,
 Kuretzenscharfer
 Cuchillos para Vegetaciones adenoides,
 Curretas cortantes, Afilador para curretas



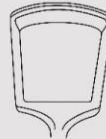
Beckmann
 22 cm / 8 3/4"



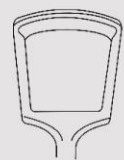
VCG400122
 Fig. 1



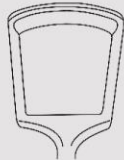
VCG400222
 Fig. 2



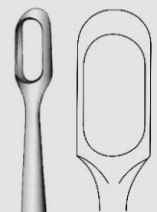
VCG400322
 Fig. 3



VCG400422
 Fig. 4



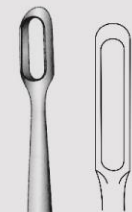
VCG400522
 Fig. 5



Tessier
 VCG401021
 21.5 cm / 8 1/2"
 12 mm



Tessier
 VCG401519
 19.5 cm / 7 3/4"
 Curette sharpener



Tessier
 VCG402021
 21.5 cm / 8 1/2"
 6 mm

رینولوژی
 کورت ها



CE

SQS Certificate
 ISO 9001:2000
 ISO 13485:2003





Rhinology

Adenoid Currettes & Cannulas
Ringmesser und Kanülen
Cuchillos para vegetaciones adenoides Y Sonda

رینولوژی



SQS Certificate
ISO 9001:2000
ISO 13485:2003

516



St. Clair-Thomson
21 cm / 8 1/4"



VCG402521
11 mm



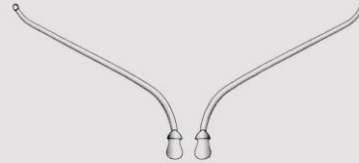
VCG402621
13 mm



VCG402721
15 mm



VCG402821
17 mm



Hartmann

Fig. 1	mmØ	Fig. 2
VCG403000	2 mm	VCG403500
VCG403100	2.5 mm	VCG403600
VCG403200	3 mm	VCG403700



Hartmann
VCG404000 2 mmØ
VCG404100 2.5 mmØ
VCG404200 3 mmØ
12 cm / 4 3/4"



Eicken-Killian
VCG404500
14 cm / 5 1/2"
3 mmØ
Irrigation cannula



Eicken-Killian
VCG405000
14 cm / 5 1/2"
3 mmØ



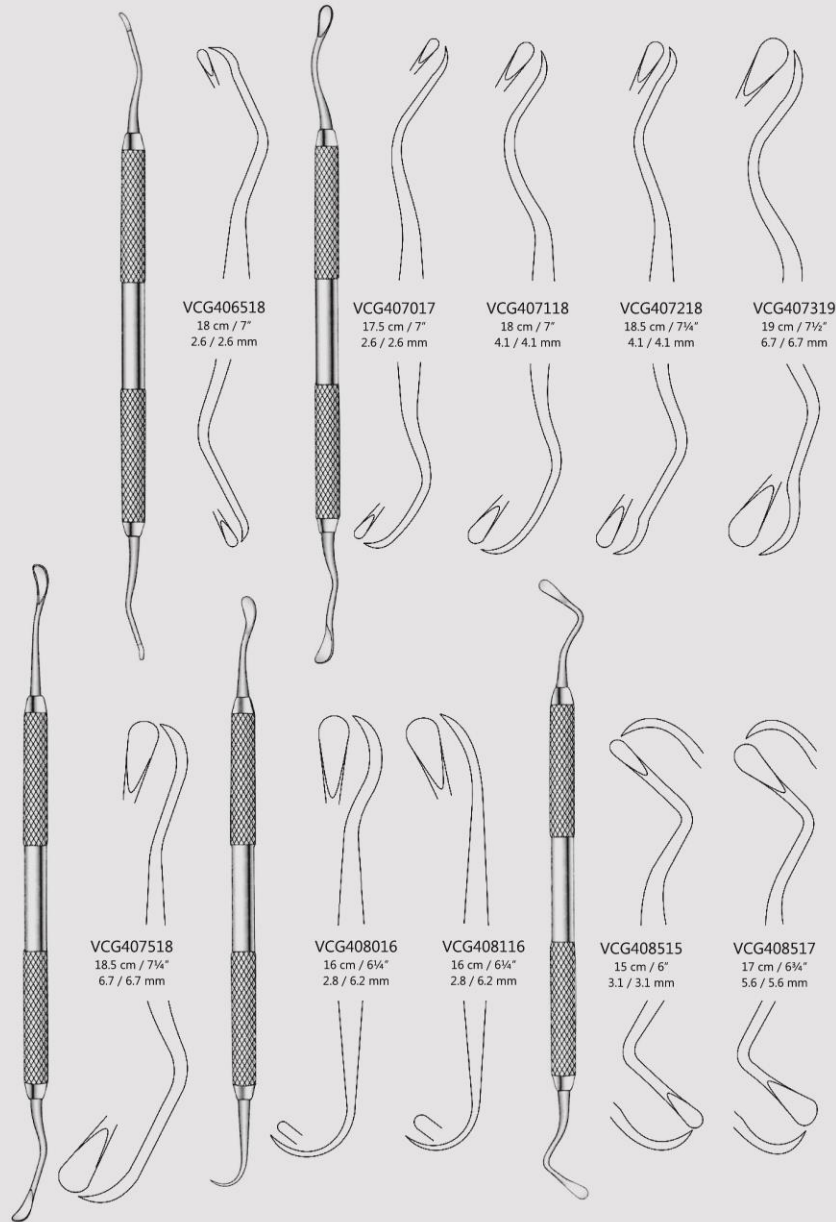
Killian
VCG405500
17 cm / 6 3/4"
1 1/2 mmØ



Marchac
VCG406019
19 cm / 7 1/2"



Oral Maxillo
Facial Surgery
Sinus Lift Currettes
Sinus Lift Kuretten
Curetas para Sinus-lift



VCG406518
18 cm / 7"
2.6 / 2.6 mm

VCG407017
17.5 cm / 7"
2.6 / 2.6 mm

VCG407118
18 cm / 7"
4.1 / 4.1 mm

VCG407218
18.5 cm / 7 1/4"
4.1 / 4.1 mm

VCG407319
19 cm / 7 1/2"
6.7 / 6.7 mm

VCG407518
18.5 cm / 7 1/4"
6.7 / 6.7 mm

VCG408016
16 cm / 6 1/4"
2.8 / 2.8 mm

VCG408116
16 cm / 6 1/4"
2.8 / 2.8 mm

VCG408515
15 cm / 6"
3.1 / 3.1 mm

VCG408517
17 cm / 6 3/4"
5.6 / 5.6 mm

فک و صورت



CE

SQS Certificate
ISO 9001:2000
ISO 13485:2003

517



Oral Maxillo Facial Surgery
Sinus Lift Curettes
Sinus Lift Kuretten
Curetas para Sinus-lift

فک و صورت



CE

SQS Certificate
ISO 9001:2000
ISO 13485:2003

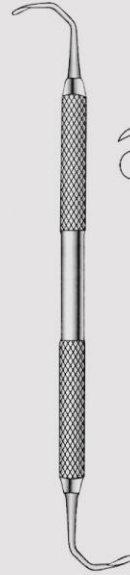
518



VCG409016
16.5 cm / 6½"
Fig. 1



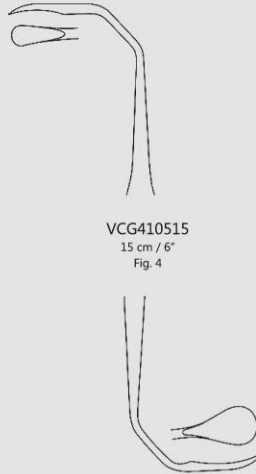
VCG409516
16.5 cm / 6½"
Fig. 2



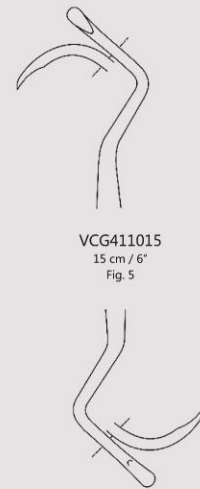
VCG410114
14 cm / 5½"
Fig. 3



VCG410515
15 cm / 6"
Fig. 4



VCG411015
15 cm / 6"
Fig. 5



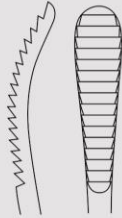


Rhinology

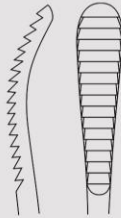
Glabella Rasps, Nasal Rasps,
Bone Files
Glabellaraspeln,
Nasenraspel, Knochenfeilen
Escofinas para glabella,
nasales, Limas Para Huesos



Aufricht
21 cm / 8¼"



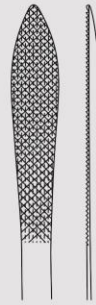
VBC326021
Single ended
forward cutting
32 x 9 mm



VBC326121
Single ended
backward cutting
32 x 9 mm



Joseph
VBC327516
16 cm / 6¼"
60 x 8 mm
Single ended, 8 mm at wide
point, fine cross serrations



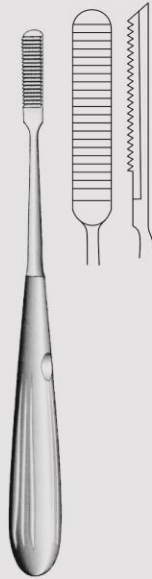
Lewis
19 cm / 7½"



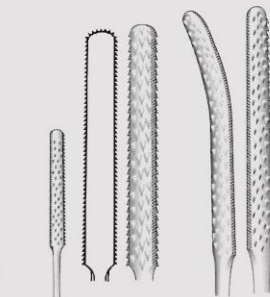
VBC328019
Fine, single ended
15 x 8 mm



VBC328119
Coarse, single ended
15 x 8 mm
Plain serrations

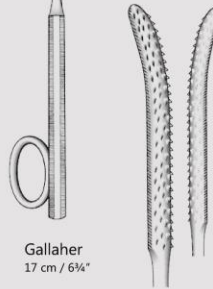


Cottle
VBC328520
21 cm / 8¼"
30 x 8 mm



VCG413517
45 x 6 mm

VCG413617
45 x 6 mm



Gallaher
17 cm / 6¾"

VCG413717
45 x 6 mm

رینولوژی
رَسپ ها



SQS Certificate
ISO 9001:2000
ISO 13485:2003

519



Rhinology
Nasal Rasps
Nasenraspel
Escofinas nasales

رینولوژی
رَسپ ها



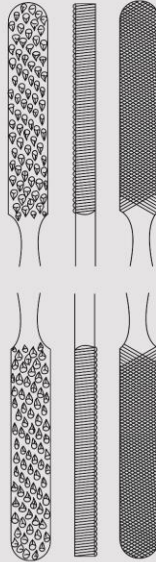
CE

SQS Certificate
ISO 9001:2000
ISO 13485:2003

520



Fomon
VBC324021
21 cm / 8 1/4"
Double ended, fine and
coarse teeth 4-side, convex and flat
blades 30 x 8 mm



Wiener
18 cm / 7"



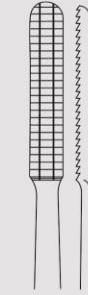
Maltz
18 cm / 7"
Single ended
10 mm width



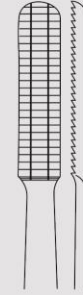
VCG415018



VCG415118



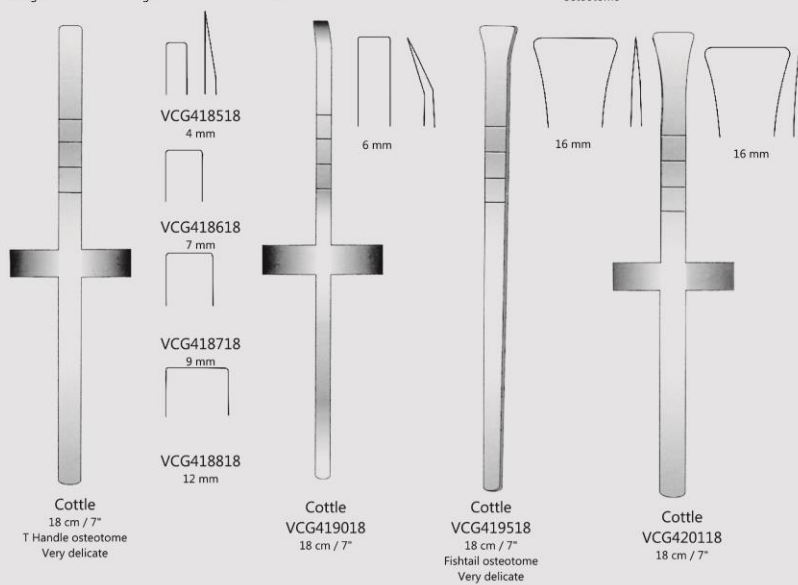
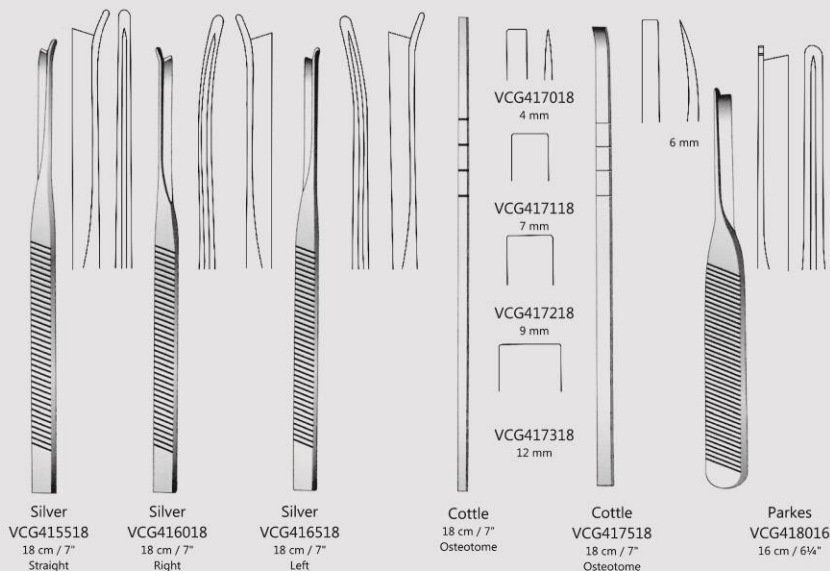
VCG414018
34 x 7 mm
Backward cutting



VCG414118
34 x 7 mm
Forward cutting



Rhinology
Rhinoplastic Chisels &
Osteotomes
Nasenmeißel und Osteotome
Cinceles nasales Y Osteotomos



رینولوژی
استاتوم ها



CE

SQS Certificate
ISO 9001:2000
ISO 13485:2003

521



Rhinology
Osteotomes
Osteotome
Osteotomos

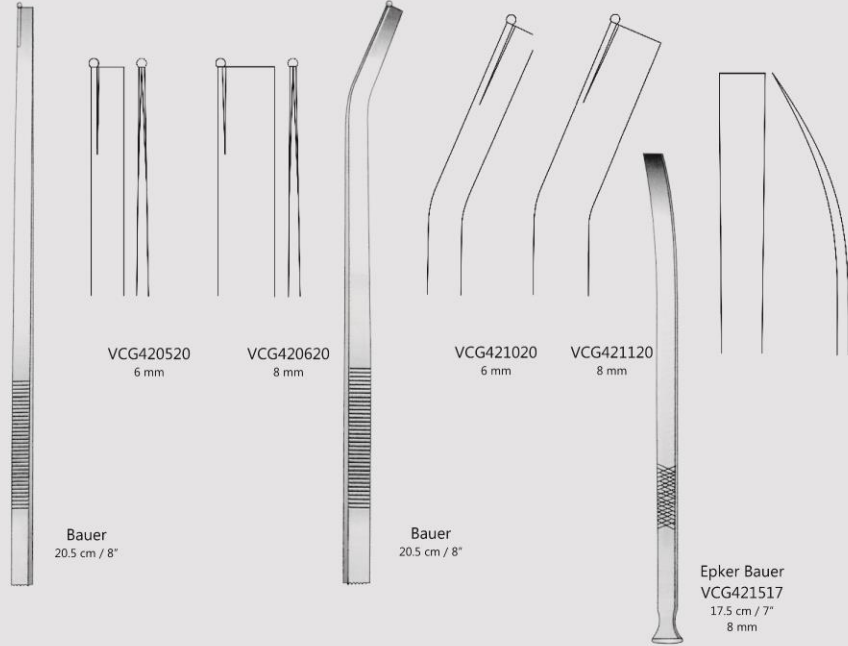
رینولوژی
استاتوم ها



CE

SQS Certificate
ISO 9001:2000
ISO 13485:2003

522



VCG420520
6 mm

VCG420620
8 mm

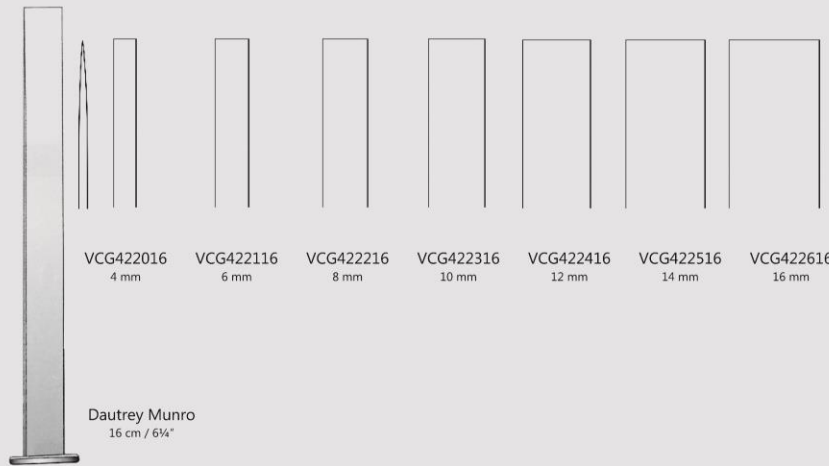
VCG421020
6 mm

VCG421120
8 mm

Bauer
20.5 cm / 8"

Bauer
20.5 cm / 8"

Epker Bauer
VCG421517
17.5 cm / 7"
8 mm



VCG422016
4 mm

VCG422116
6 mm

VCG422216
8 mm

VCG422316
10 mm

VCG422416
12 mm

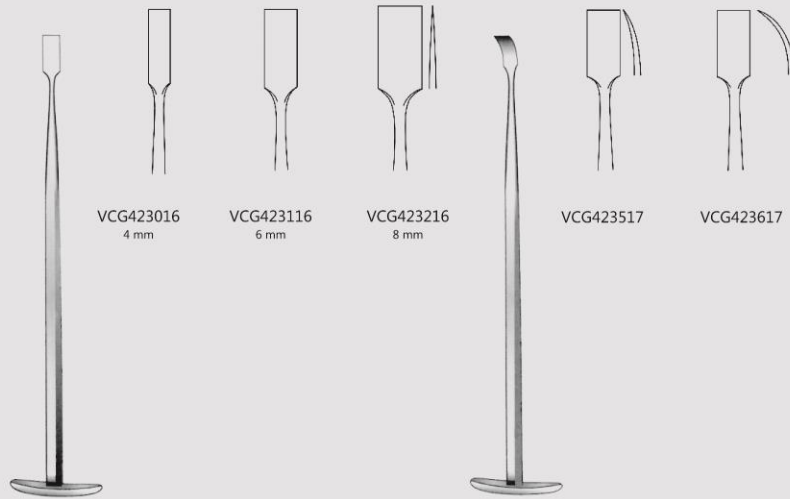
VCG422516
14 mm

VCG422616
16 mm

Dautrey Munro
16 cm / 6 1/4"



Rhinology
Osteotomes
Osteotome
Osteotomos



VCG423016
4 mm

VCG423116
6 mm

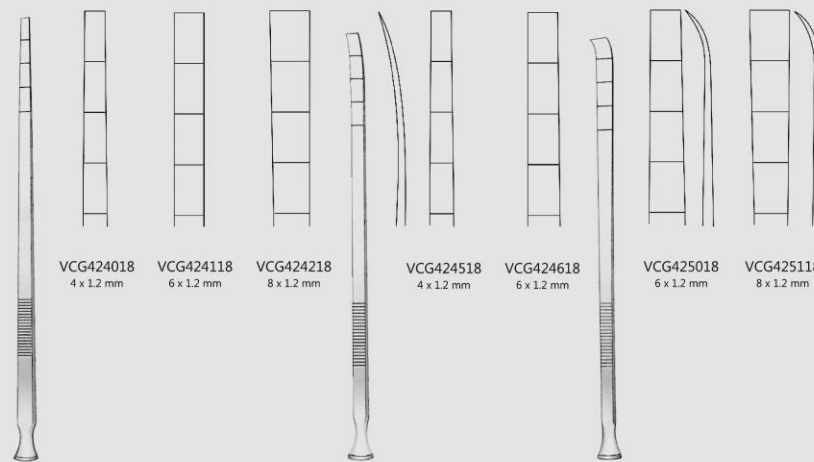
VCG423216
8 mm

VCG423517

VCG423617

Dunn Dautrey
16.5 cm / 6½"

Dunn Dautrey
17 cm / 6¾"
6 mm



VCG424018
4 x 1.2 mm

VCG424118
6 x 1.2 mm

VCG424218
8 x 1.2 mm

VCG424518
4 x 1.2 mm

VCG424618
6 x 1.2 mm

VCG425018
6 x 1.2 mm

VCG425118
8 x 1.2 mm

Epker
18 cm / 7"

Epker
18 cm / 7"

Epker
18 cm / 7"

رینولوژی
استاتوم ها



CE

SQS Certificate
ISO 9001:2000
ISO 13485:2003

523



Rhinology

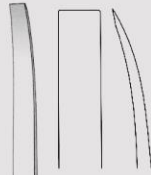
Wälzler, Weber, Witz, Zinnober, Pergande & Seppel, Gossamer, Durr, Rehnert
Türker, Müller, Dürschmid, Hirsch, Pergande & Seppel, Gossamer, Durr, Rehnert
Türker, Müller, Dürschmid, Hirsch, Pergande & Seppel, Gossamer, Durr, Rehnert

رینولوژی استاتوم ها

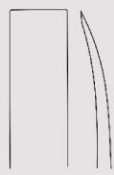


CE
SQS Certificate
ISO 9001:2000
ISO 13485:2003

524



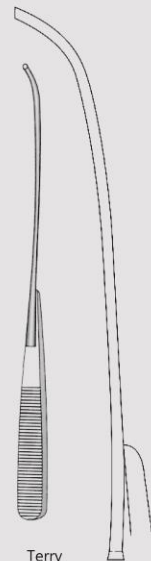
VCG425523
8 mm



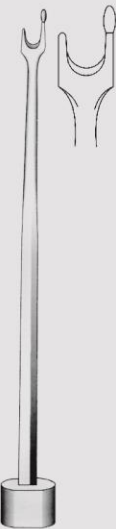
VCG425623
11 mm



VCG426022
22 cm / 8 3/4"



Terry
VCG426517
17 cm / 6 1/2"



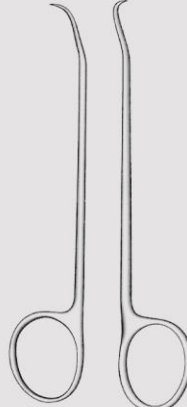
Terry
VCG427019
19 cm / 7 1/2"

Obwegeser
23.5 cm / 9 1/4"

Hargis



Terry
VCG427514
14 cm / 5 1/2"
Occlusal wedge

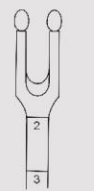


Terry
VCG428015
15 cm / 6"
Left

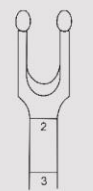
Terry
VCG428515
15 cm / 6"
Right



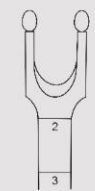
Obwegeser
18.5 cm / 7 1/4"
Graduated



VCG429018
4 mm



VCG429118
6 mm

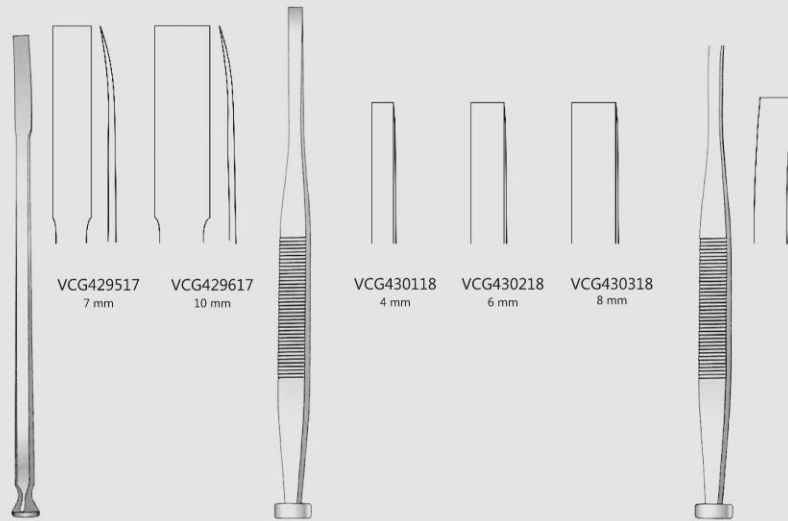


VCG429218
8 mm



Rhinology

Ramus Osteotomes, Chisels
Ramusosteotome, Meißel
Osteotomos de rama, Cinceles



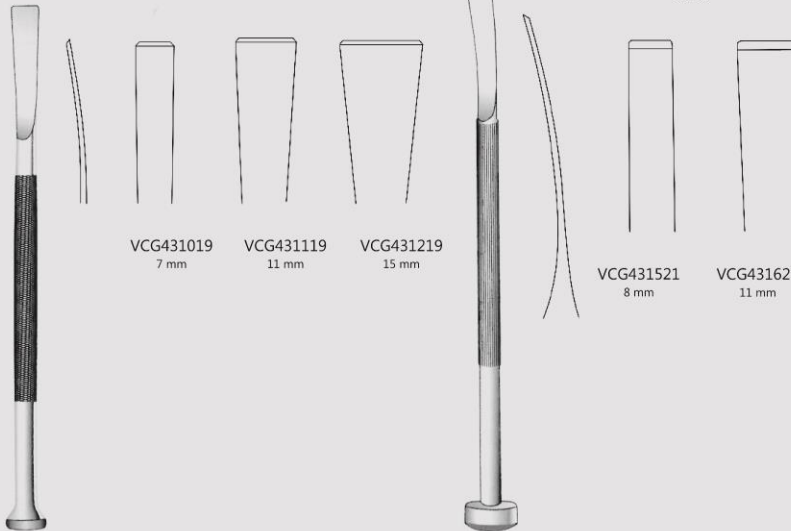
VCG429517 7 mm
VCG429617 10 mm

VCG430118 4 mm
VCG430218 6 mm
VCG430318 8 mm

Steinhauser
17 cm / 6 3/4"
Flexible

Marchac
18.5 cm / 7 1/4"

Marchac
VCG430518
18.5 cm / 7 1/4"
6 mm
Curved



VCG431019 7 mm
VCG431119 11 mm
VCG431219 15 mm

VCG431521 8 mm
VCG431621 11 mm

Steinhauser
19 cm / 7 1/2"
Flexible

Obwegeser
21 cm / 8 1/4"
Elastic blade

رینولوژی
استاتوم ها



CE

SQS Certificate
ISO 9001:2000
ISO 13485:2003

525



Rhinology

Raspatories, Osteotomes, Maxillary Mobilizer
Raspatorien, Osteotome, Maxilla-Mobilisator
Legras, Osteotomos, Mobilizador maxilar

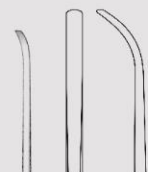
رینولوژی
استاتوم ها



CE

SQS Certificate
ISO 9001:2000
ISO 13485:2003

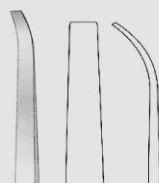
526



VCG432016
16.5 cm / 6½"
3 mm



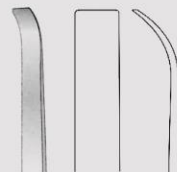
Steinhauser



VCG432518
18 cm / 7"
5 mm



Steinhauser



VCG433018
18 cm / 7"
8 mm

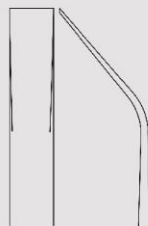


Steinhauser



VCG433523
6 mm

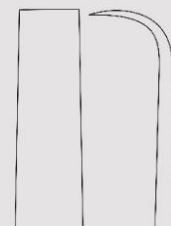
Wolford
23 cm / 9"



VCG433623
8 mm

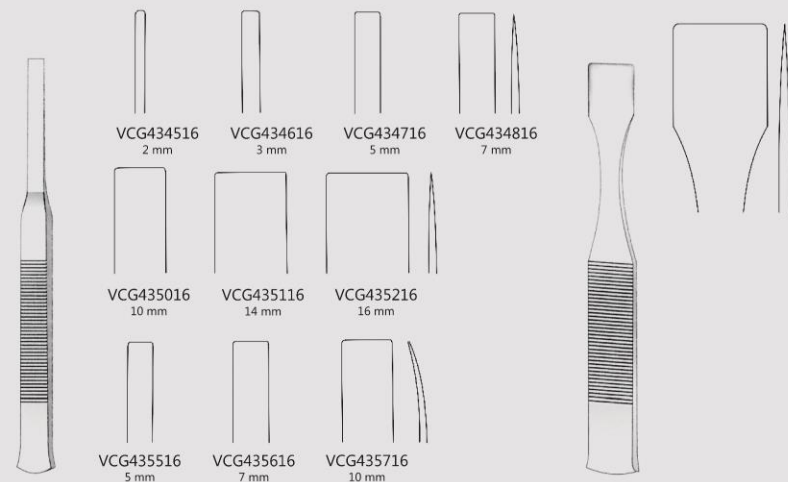


Obwegeser
VCG434023
23 cm / 9"
12 mm





Rhinology
Osteotomes
Osteotome
Osteotomos



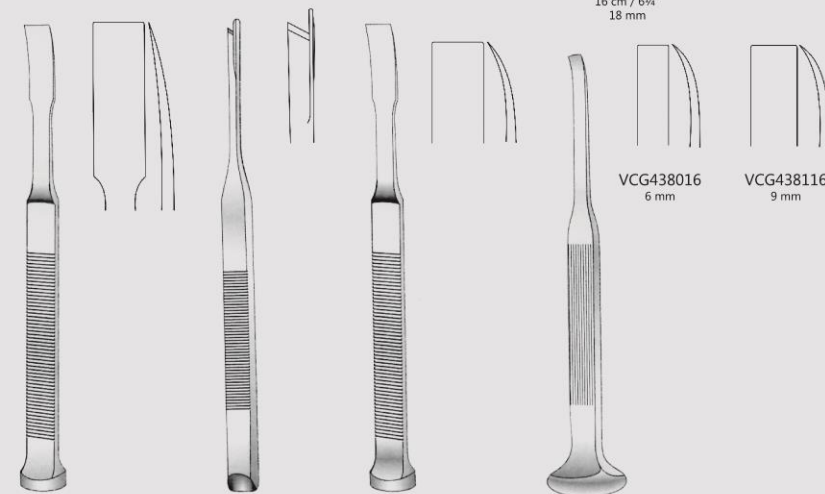
VCG434516 2 mm
VCG434616 3 mm
VCG434716 5 mm
VCG434816 7 mm

VCG435016 10 mm
VCG435116 14 mm
VCG435216 16 mm

VCG435516 5 mm
VCG435616 7 mm
VCG435716 10 mm

Tessier
16 cm / 6¼"

Tessier
VCG436016
16 cm / 6¼"
18 mm



VCG438016
6 mm

VCG438116
9 mm

Tessier
VCG436518
18 cm / 7"
10 mm

Tessier
VCG437018
18.5 cm / 7¼"
Septonasal osteotome

Tessier
VCG437518
18 cm / 7"
10 mm

Tessier
16.5 cm / 6½"
Retromaxillary chisel

رینولوژی
استاتوم ها



CE

SQS Certificate
ISO 9001:2000
ISO 13485:2003

527



Rhinology

Osteotomes
Osteotome
Osteotomos

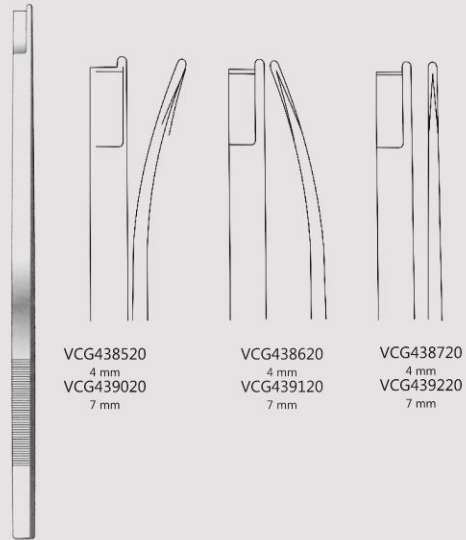
رینولوژی
استاتوم ها



CE

SQS Certificate
ISO 9001:2000
ISO 13485:2003

528

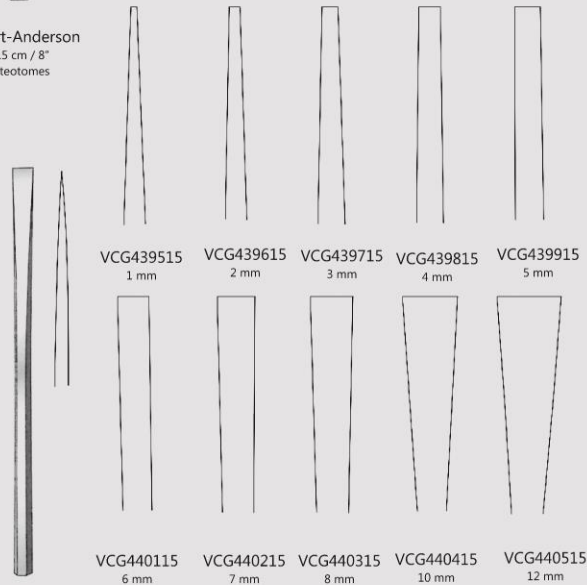


VCG438520
4 mm
VCG439020
7 mm

VCG438620
4 mm
VCG439120
7 mm

VCG438720
4 mm
VCG439220
7 mm

Neivert-Anderson
20.5 cm / 8"
Osteotomes



VCG439515
1 mm

VCG439615
2 mm

VCG439715
3 mm

VCG439815
4 mm

VCG439915
5 mm

VCG440115
6 mm

VCG440215
7 mm

VCG440315
8 mm

VCG440415
10 mm

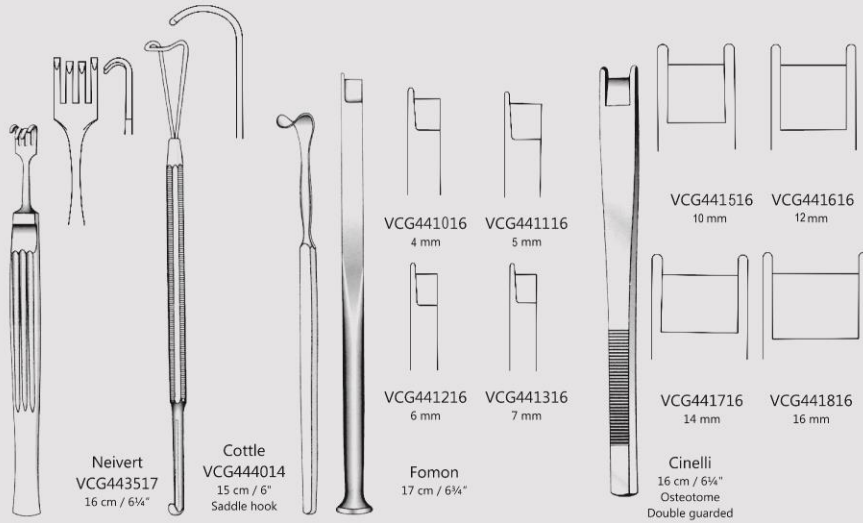
VCG440515
12 mm

Sheehan
15 cm / 6"



Rhinology

Osteotomes, Alar Hooklets, Nasal Retractors
Osteotome, Nasenflügelhäkchen, Nasenhaken
Osteotomos, Ganchitos para alas de nariz, Separadores nasales



Neivert
VCG443517
16 cm / 6¼"

Cottle
VCG444014
15 cm / 6"
Saddle hook

VCG441016
4 mm

VCG441116
5 mm

VCG441216
6 mm

VCG441316
7 mm

Fomon
17 cm / 6¾"

VCG441516
10 mm

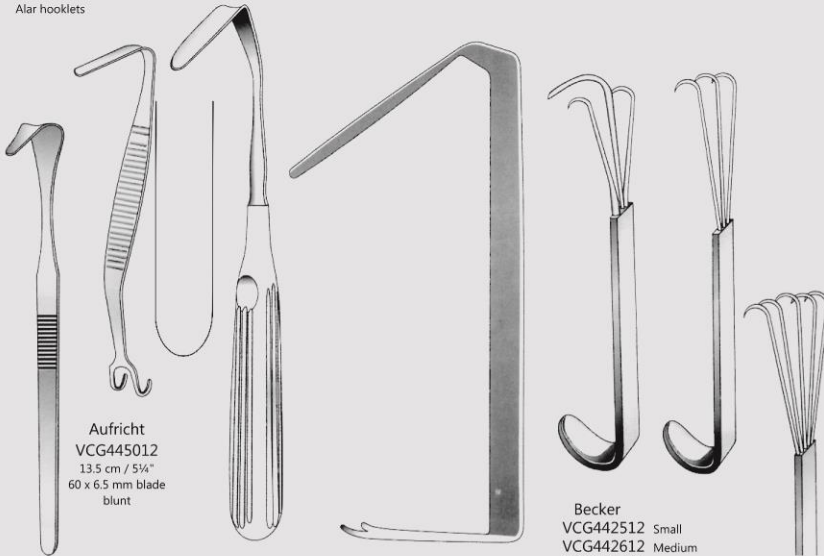
VCG441616
12 mm

VCG441716
14 mm

VCG441816
16 mm

Cinelli
16 cm / 6¼"
Osteotome
Double guarded

Cottle
VCG442014
14 cm / 5½"
Alar hooklets



Aufricht
VCG445012
13.5 cm / 5¼"
60 x 6.5 mm blade
blunt

Cottle
VCG444516
15 cm / 6"

Aufricht
VCG445519
19 cm / 7½"
40 x 12 mm blade

Aufricht
VCG445516
16 cm / 6¼"
45 x 6 mm blade

Aufricht
VCG446011
11 cm / 4¼"
50 x 6 mm

Becker
VCG442512 Small
VCG442612 Medium
VCG442712 Large
VCG442812 X-Large
12 cm / 4¾"
Plastic surgery, american made
open retractors

Anderson
VCG443012 Three prong
VCG443112 Five prong
12 cm / 4¾"

Short
VCG443016 Three prong
VCG443116 Five prong
16 cm / 6¼"
Long
Plastic surgery, american
made retractor



SQS Certificate
ISO 9001:2000
ISO 13485:2003

529



Rhinology

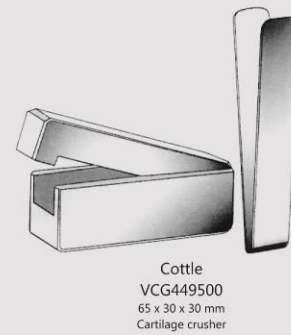
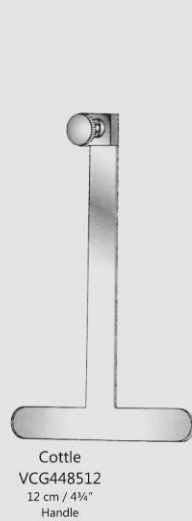
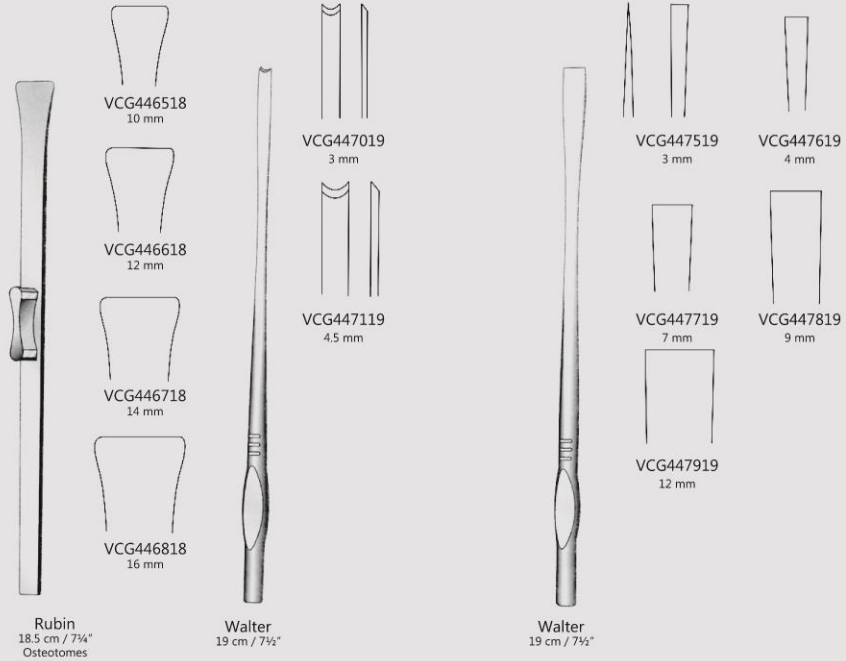
Osteotomes, Gouges, Cartilage Crusher
Osteotome, Hohmeißel, Knorpelquetsche
Osteotomos, Gubias, Machacadora

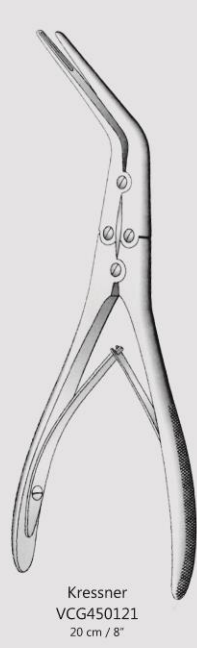
رینولوژی
استاتوم ها



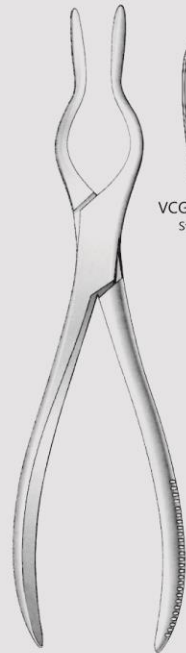
SQS Certificate
ISO 9001:2000
ISO 13485:2003

530

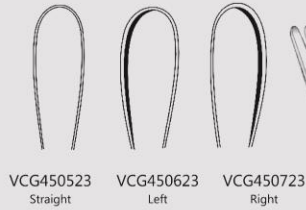




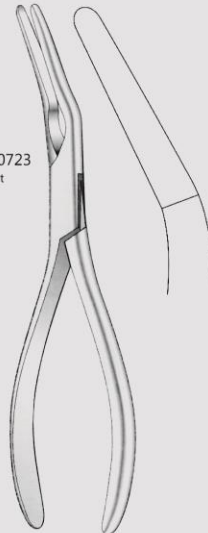
Kressner
VCG450121
20 cm / 8"



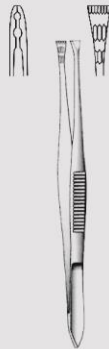
Cottle-Walsham
23 cm / 9"



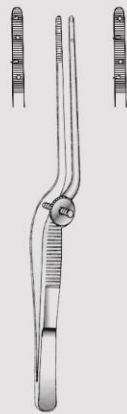
VCG450523 Straight
VCG450623 Left
VCG450723 Right



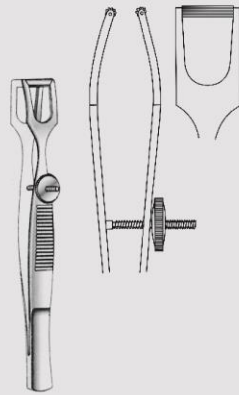
Asch
VCG451022
23 cm / 9"



Ogura
VCG451511
11 cm / 4 1/4"
4 mm wide



Cottle
VCG452014
14 cm / 5 1/2"
1.7 mm wide with teeth



Cottle
VCG452511
11 cm 4 1/4"
12 mm wide
Columella forceps



Aiach
VCG453015
15.5 cm / 6"
5 mm wide
Columella suturing forceps



Rhinology

Septum Forceps, Septum
Straightening Forceps,
Skin Grasping Forceps
Septumzangen,
Septumrichtzangen,
Hautfasspinzetten
Pinzas para tabique nasal,
Pinzas para enderezar el
tabique nasal, Pinzas para piel

رینولوژی
پنس ها



CE

SQS Certificate
ISO 9001:2000
ISO 13485:2003

531



Rhinology

Rhinoplastic Instruments etc.
Instrumente zur Nasenplastik usw.
Instrumentos para la plastica nasal etc.

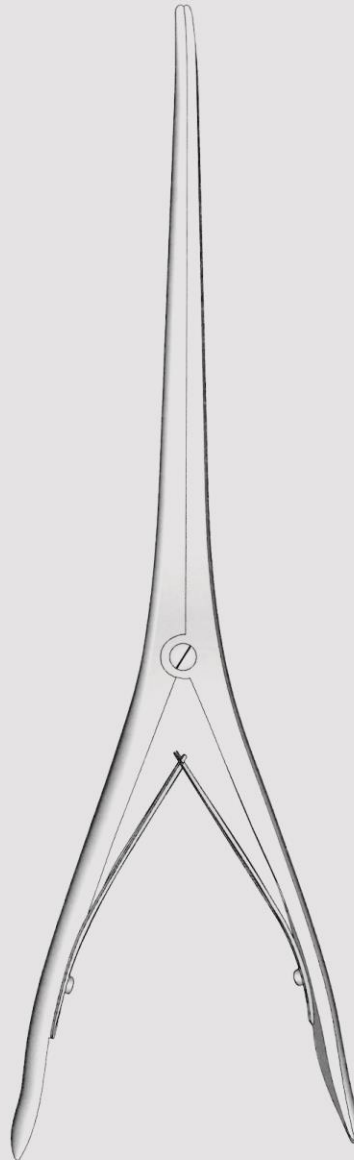
رینولوژی
رینوپلاستی



CE

SQS Certificate
ISO 9001:2000
ISO 13485:2003

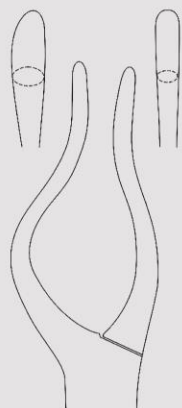
532



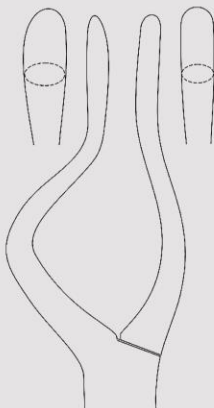
LaRoe Tissue Spreaders
VCG453523 Straight
VCG453623 Curved
23 cm / 9"
Small
VCG453526 Tapered, mod
VCG453626 Curved
26 cm / 10 1/4"
Large



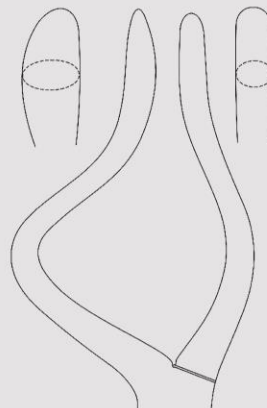
Rhinology
Disimpaction Forceps
Repositionszangen
Pinzas para reposicion



VCG454022 Left
VCG454024 Right



VCG454122 Left
VCG454124 Right



VCG454222 Left
VCG454224 Right



Rowe
22.5 cm / 9"
Left



Rowe
24 cm / 9 1/2"
Right

رینولوژی
پنس ها



CE

SQS Certificate
ISO 9001:2000
ISO 13485:2003

533



Rhinology
Disimpaction Forceps
Repositionszangen
Pinzas de reposicion

رینولوژی
پنس ها



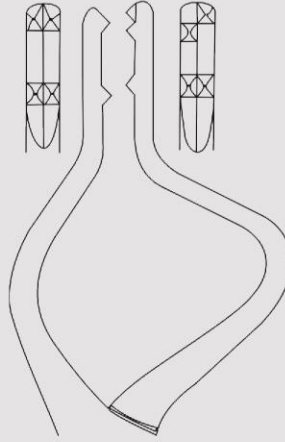
CE

SQS Certificate
ISO 9001:2000
ISO 13485:2003

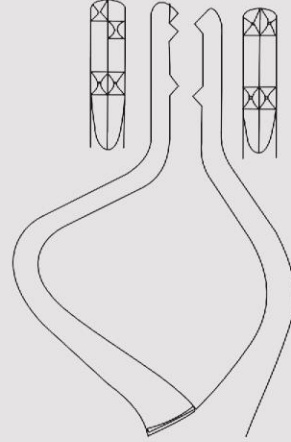
534



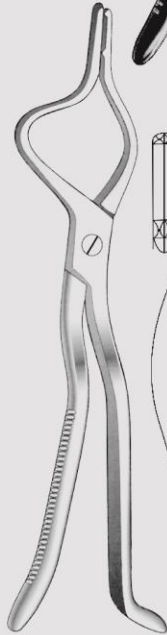
Tessier
23 cm / 9"
For adults



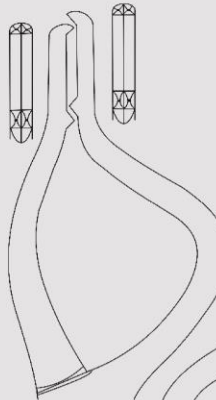
VCG455023
Left



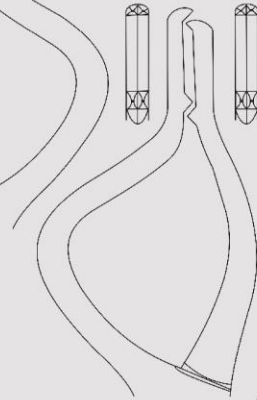
VCG455123
Right



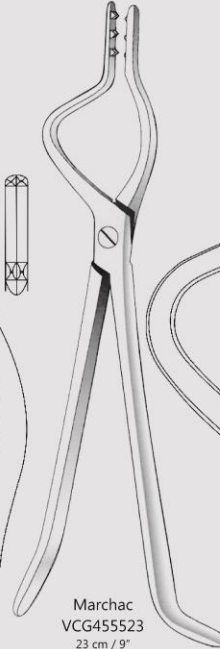
Tessier
22 cm / 8 3/4"
For children



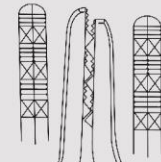
VCG454522
Left



VCG454622
Right



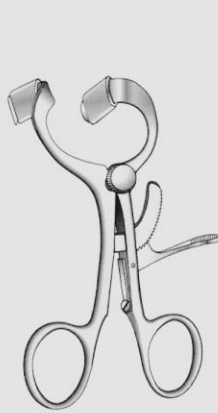
Marchac
VCG455523
23 cm / 9"
For children



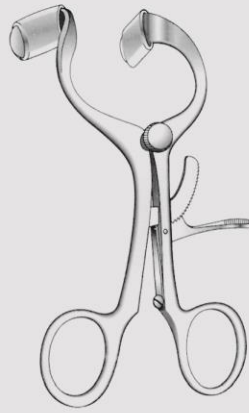
Tessier
23 cm / 9"
For adults



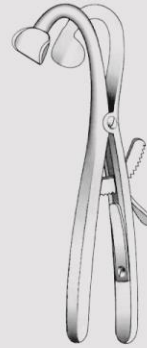
Oral Instruments
Mouth Gags
Mundsperrer
Abre bocas



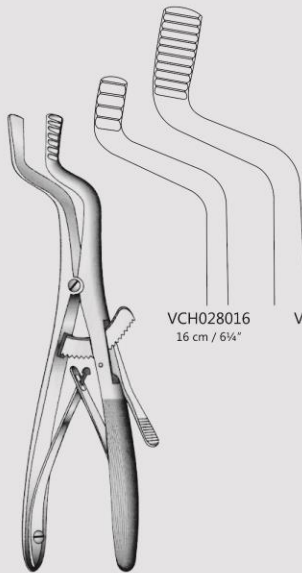
Molt/Doyen
VCH026211
11 cm / 4 1/4"



Molt/Doyen
VCH026214
14 cm / 5 1/2"



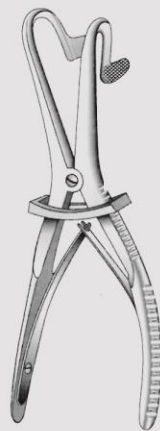
Denhart
VCH027212
12 cm / 4 1/4"
16 mm jaw



Roser-Konig

VCH028016
16 cm / 6 1/4"

VCH028019
19 cm / 7 1/2"



VCH300116
VCH300119
Ackland jaws

Fergusson

16 cm / 6 1/4"
19 cm / 7 1/2"

VCH300216
VCH300219
Parallel jaws

Mason
VCH300516 16 cm / 6 1/4"
VCH300519 19 cm / 7 1/2"
Ackland jaws

VCH300616
VCH300619
Parallel jaws

فک و صورت
دهان بازکن



CE

SQS Certificate
ISO 9001:2000
ISO 13485:2003

535



Oral Instruments

Mouth Gags
Mundsperrer
Abrebocas

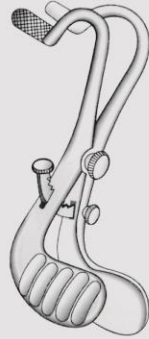
فک و صورت



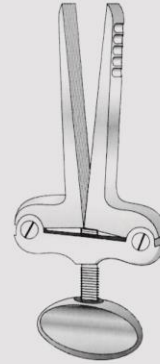
CE

SQS Certificate
ISO 9001:2000
ISO 13485:2003

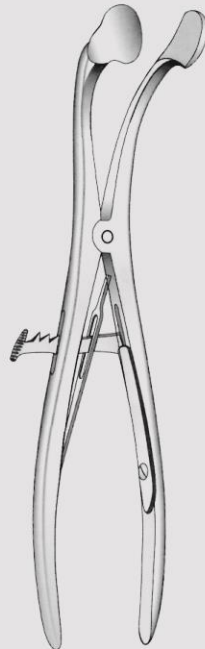
536



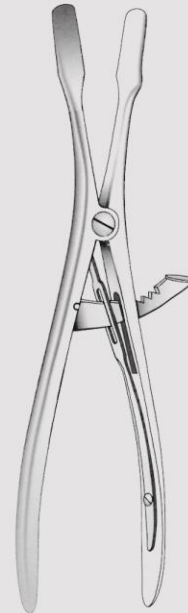
Buxton
VCH301000 Ackland jaws
VCH301100 Parallel jaws



Heister
VCH024113
13 cm / 5"



Delabarre
VCH301520
20 cm / 8"

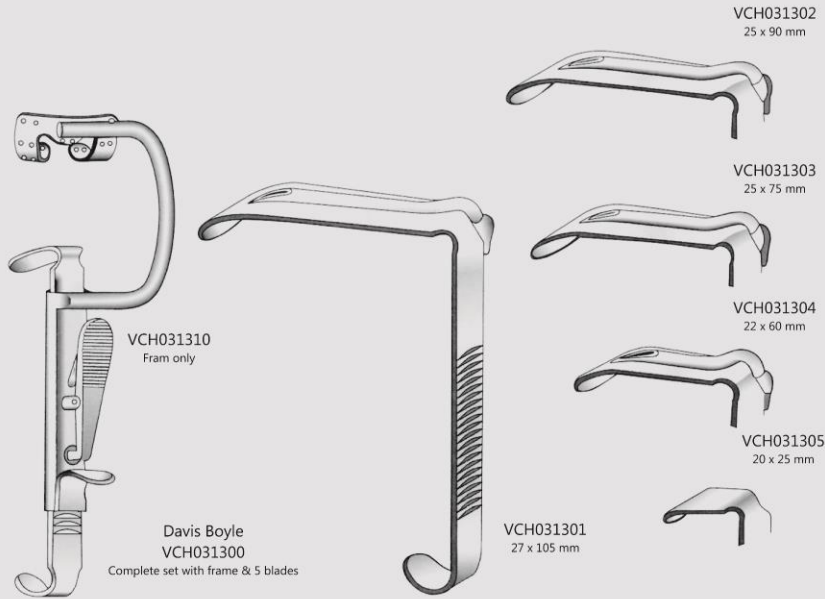


Terrier
VCH302020 Straight
VCH302120 Curved
20 cm / 8"



Oral Instruments
Mouth Gags
Mundsperrer
Abreibocas

فک و صورت
دیویس گگ



CE

SQS Certificate
ISO 9001:2000
ISO 13485:2003





Oral Instruments
Mouth Gags
Mundsperrer
Abrebocas

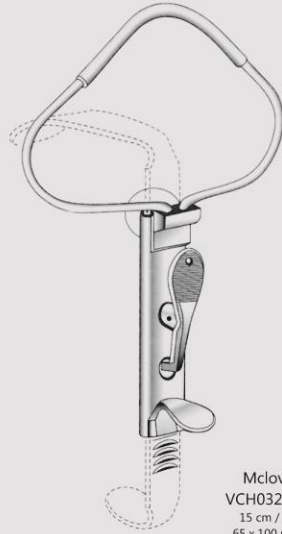
فک و صورت
دیویس گگ



CE

SQS Certificate
ISO 9001:2000
ISO 13485:2003

538

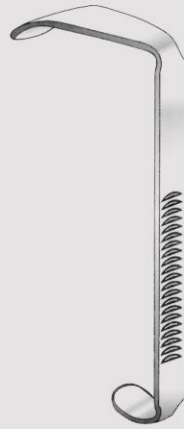


Mclovr
VCH032310
15 cm / 6"
65 x 100 mm
Frame for mouth gag

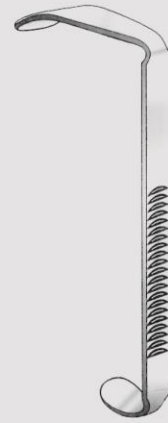
VCH032300
Complete with frame
and 3 tongue blades



Mclovr
VCH032301
13.5 cm / 5¼"
100 x 26 mm
Tongue depressor



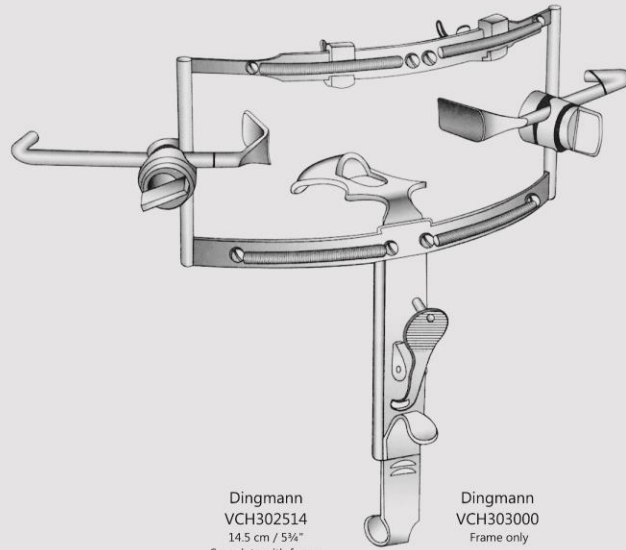
Mclovr
VCH032302
13.5 cm / 5¼"
85 x 25 mm
Tongue depressor



Mclovr
VCH032303
13.5 cm / 5¼"
75 x 23 mm
Tongue depressor



Oral Instruments
Mouth Gags
Mundsperrer
Abre bocas



Dingmann
VCH302514
14.5 cm / 5 3/4"
Complete with frame,
3 tongue depressors
and 2 adjustable lateral blades

Dingmann
VCH303000
Frame only

فک و صورت
دیویس گگ



Dingmann
VCH303113
13.5 cm / 5 1/4"
65 x 25 mm
Tongue depressor

Dingmann
VCH303213
13.5 cm / 5 1/4"
70 x 29 mm
Tongue depressor

Dingmann
VCH303313
13.5 cm / 5 1/4"
80 x 32 mm
Tongue depressor



CE

SQS Certificate
ISO 9001:2000
ISO 13485:2003

539



Oral Instruments

Mouth Gags and Finger Protector
Mundsparrer und Fingerschutz
Abreboças Y Dedal

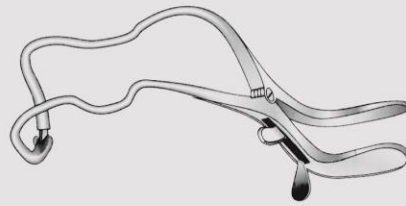
فک و صورت
دهان بازکن



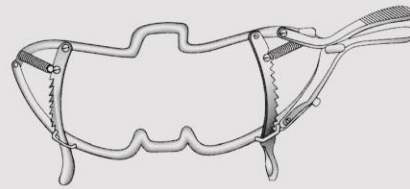
CE

SQS Certificate
ISO 9001:2000
ISO 13485:2003

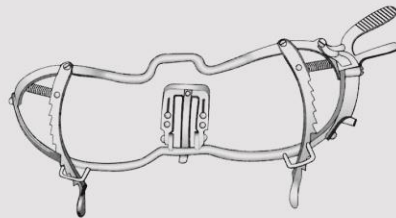
540



Jenning
VCH033809 9 cm / 3½"
VCH033811 11 cm / 4¼"
VCH033813 13 cm / 5"
VCH033815 15 cm / 6"



Whitehead
VCH033211 11 cm / 4¼"
VCH033213 13 cm / 5"
VCH033215 15 cm / 6"



Whitehead
VCH200111 11 cm / 4¼"
VCH200113 13 cm / 5"
VCH200115 15 cm / 6"



Langenbeck
VCH021201



Langenbeck
VCH021202



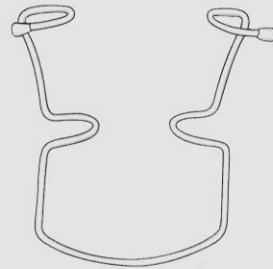
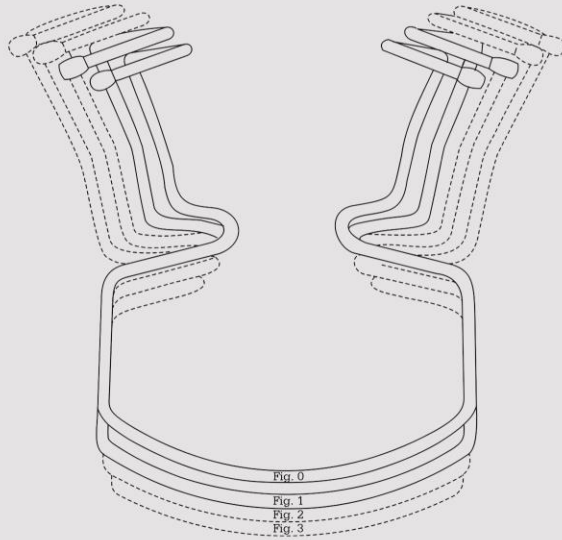
Langenbeck
VCH021203



Oral Instruments

Lip and Cheek Retractors
Lippen- u. Wangenhalter
Separadores para labios Y mejillas

فک و صورت



Oringer
Self retaining

VCH034100	Fig. 0
9.5 cm / 3 3/4"	
95 mm	
For children	
VCH034101	Fig. 1
10 cm / 4"	
110 mm	
VCH034102	Fig. 2
10.5 cm / 4"	
115 mm	
VCH034103	Fig. 3
11 cm / 4 1/4"	
120 mm	
VCH034113	Set of 3; Fig. 1 - Fig. 3



CE

SQS Certificate
ISO 9001:2000
ISO 13485:2003

541



Oral Instruments

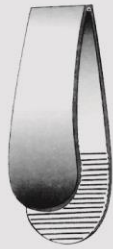
Tongue Depressors & Spatula
Zungendrucker und Zungenspatel
Abaja Lengua Y Espatulas linguales

فک و صورت
آبسلانگ



SQS Certificate
ISO 9001:2000
ISO 13485:2003

542



Tobold
VCH303512
12 cm / 4 3/4"



Mayo
VCH048317
17 cm / 6 1/2"



VCH047414
14 cm / 5 1/2"



VCH047214
14 cm / 5 1/2"



Doyen
VCH047613
13 cm / 5"
24/30 mm
VCH047616
16 cm / 6 1/4"
30/34 mm



Bruenings
VCH048619
19 cm / 7 1/2"
19/15 mm



Collin
VCH049416
16.5 cm / 6 1/2"



Frenzel
VCH049816
16.5 cm / 6 1/2"



Buchwald
VCH046217
17 cm / 6 3/4"



VCH045116
16 cm / 6 1/4"
Wood



VCH045716
15 cm / 6"
Acrylic glass



VCH046418
18.5 cm / 7 1/4"
Nylon



Oral Instruments
Lip and Cheek Retractors
Lippen- u. Wangenhalter
Separadores para labios y mejillas



Simplex
VCH034411
10.5 cm / 4"

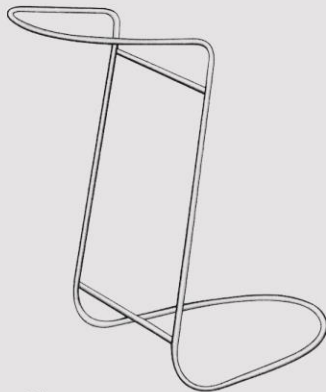


VCH304014
14 cm / 5½"
Vestibulum retractor

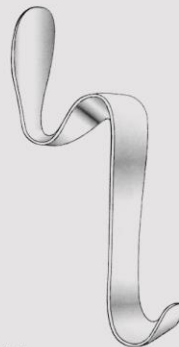


Sternberg
VCH035012 12 cm / 4¾"
VCH035014 14 cm / 5½"
VCH035016 16 cm / 6¼"

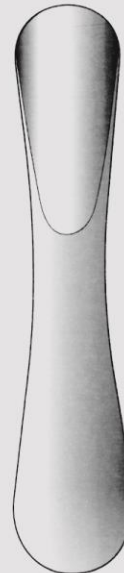
فک و صورت



Obwegeser
VCH304512
12 cm / 4¾"



Bishop
VCH036213
13.5 cm / 5¼"
27 mm



Jaeger
VCH305010 Stainless steel
VCH305110 Plastic
10 cm / 4"
Lid plate



CE

SQS Certificate
ISO 9001:2000
ISO 13485:2003

543



Oral Instruments

Cheek & Nasal Retractors, Alar Hooklet
Wagenhalter und Nasenhaken, Nasenflügelhakchen
Separadores para mejilla y nariz, Ganchos para alas de nariz

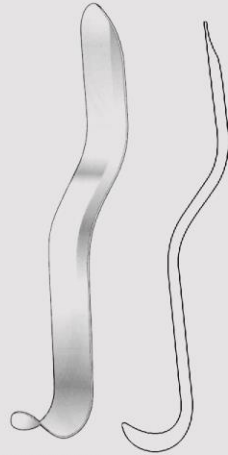
فک و صورت
اکارتورها



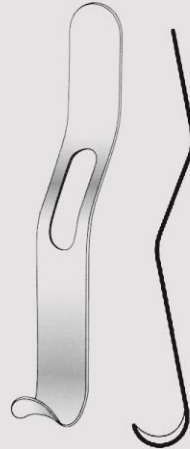
CE

SQS Certificate
ISO 9001:2000
ISO 13485:2003

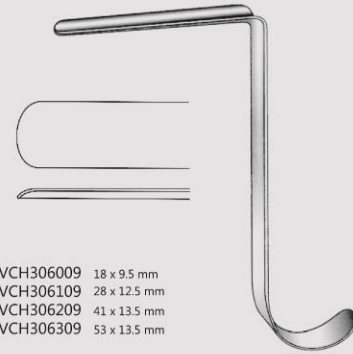
544



Cawood Minnesota
VCH036415
15 cm / 6"
20 mm



VCH305514
14.5 cm / 5 3/4"
Fenestrated

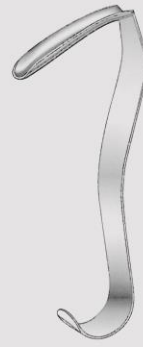
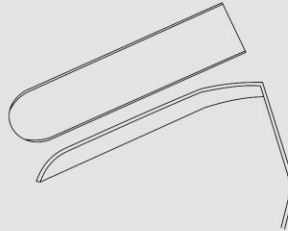


VCH306009 18 x 9.5 mm
VCH306109 28 x 12.5 mm
VCH306209 41 x 13.5 mm
VCH306309 53 x 13.5 mm

Converse
9 cm / 3 1/2"



Lange
VCH306523
23 cm / 9"
Alar hooklet, button end



Converse
VCH307010
10.5 cm / 4"
44 x 11 mm blade



VCH307515 1.5 mm Ø
VCH307615 1.7 mm Ø
VCH307715 2.0 mm Ø
VCH307815 2.5 mm Ø
VCH307915 3.0 mm Ø

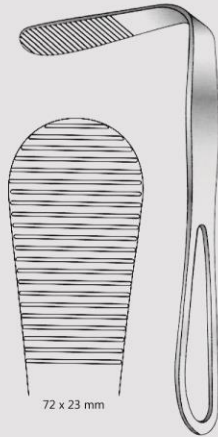
Siebenmann
15 cm / 6"
Antrum cannula



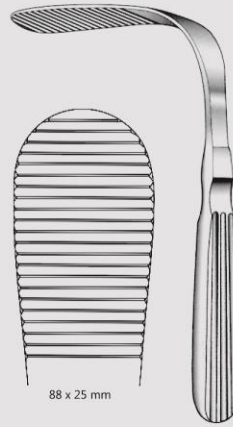
Oral Instruments
Tongue Depressors
Zungendrucker
Abajalenguas



Bosworth
VCH308514
14 cm / 5½"

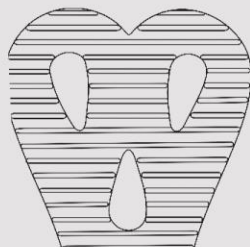


Hartmann
VCH037215
15 cm / 6"

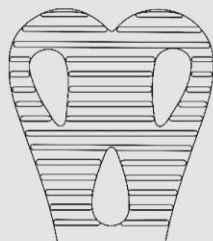


Tobold
VCH037814
15 cm / 6"

Tobold
VCH038214
14 cm / 5½"



VCH039801
14 cm / 5½"
36 mm



VCH039802
15 cm / 6"
43 mm



Lack
VCH309010
10 cm / 4"

Wieder

فک و صورت
اکار توها



SQS Certificate
ISO 9001:2000
ISO 13485:2003

545



Oral Instruments
Tongue Holding Forceps
Zungenzangen
Pinzas tira lengua

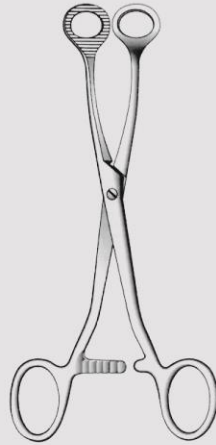
فک و صورت
پنس ها



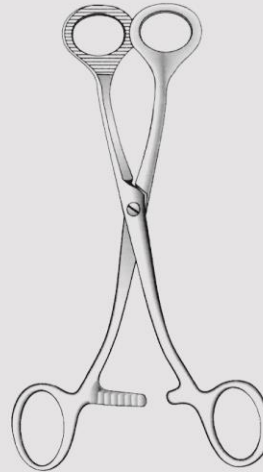
CE

SQS Certificate
ISO 9001:2000
ISO 13485:2003

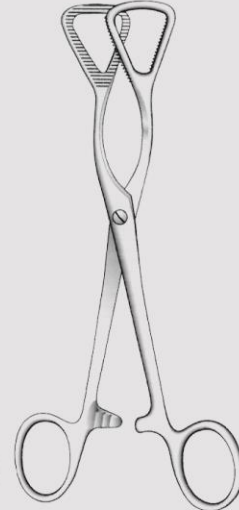
546



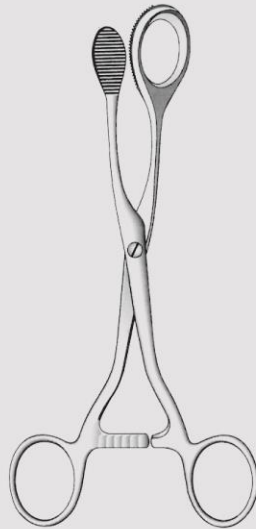
Collin
VCH309516
16 cm / 6¼"



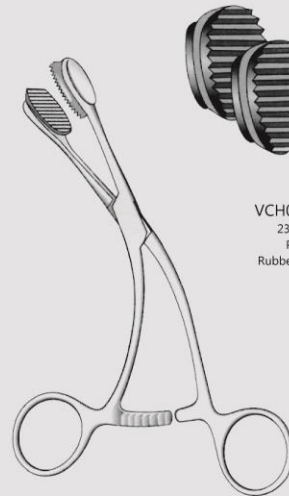
Collin
VCH201016 16 cm / 6¼"
VCH201017 17 cm / 6¼"
VCH201019 19 cm / 7½"



Guy
VCH055919
19 cm / 7½"

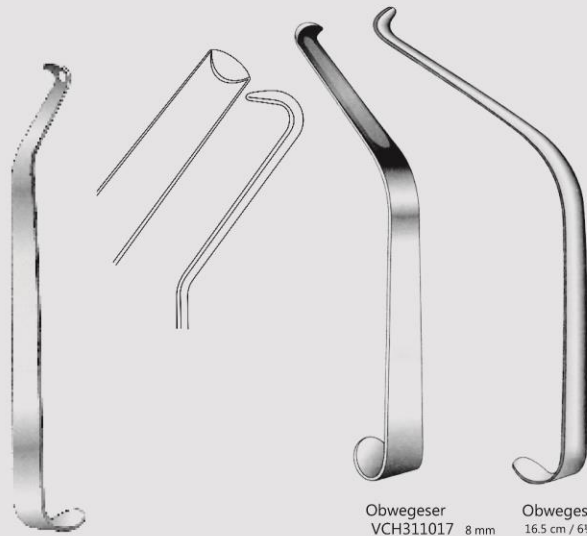


Mathieu
VCH310119
19 cm / 7½"



Young
VCH056817
17 cm / 6¼"

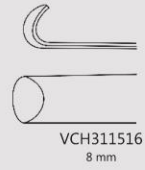
VCH056902
23 x 15
Pair
Rubber Inserts



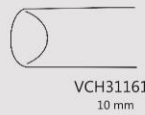
Terry
VCH310516
16.5 cm / 6½"

Obwegeser
VCH311017 8 mm
VCH311117 10 mm
17 cm / 6¾"

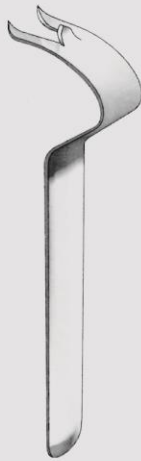
Obwegeser
16.5 cm / 6½"



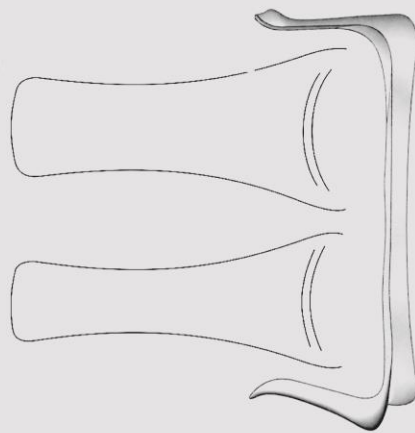
VCH311516
8 mm



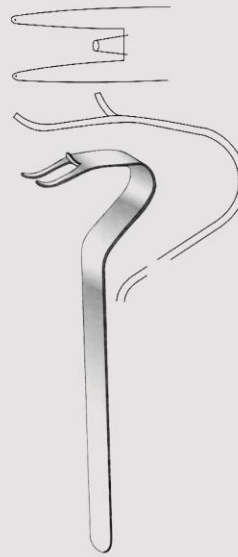
VCH311616
10 mm



Obwegeser
VCH312016
16.5 cm / 6½"



Hargis
VCH312516
16 cm / 6¼"
Lip and cheek retractors



Obwegeser
VCH313016
16 cm / 6¼"
16.5 mm
Chin holder



Oral Instruments

Chin, Channel &
Ramus Retractors
Kinnhalter, Progenierinnen
und Ramushaken
Gancho de menton, Separadores
mandibulares Y de Rama

فک و صورت
اکار تورها



CE

SQS Certificate
ISO 9001:2000
ISO 13485:2003

547



Oral Instruments
Soft Tissue Retractors
Weichteilhaken
Separadores para partes blandas

فک و صورت
اکارتورها



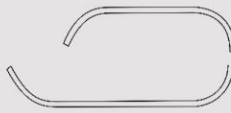
CE

SQS Certificate
ISO 9001:2000
ISO 13485:2003

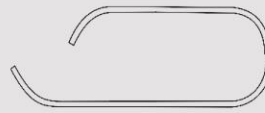
548



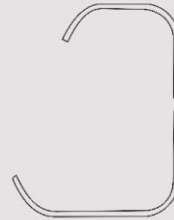
VCH314015
20 x 12 ; 30 x 16 mm



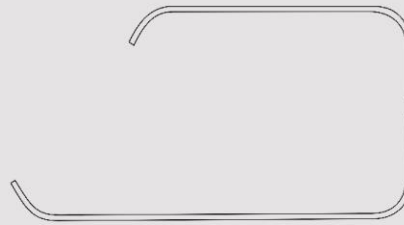
VCH314115
30 x 12 ; 35 x 16 mm



VCH314215
35 x 12 ; 45 x 16 mm



VCH313515
20 x 7 ; 30 x 10 mm



VCH314515
50 x 12 ; 70 x 16 mm



Tessier
15 cm / 6"
Black chromium plated



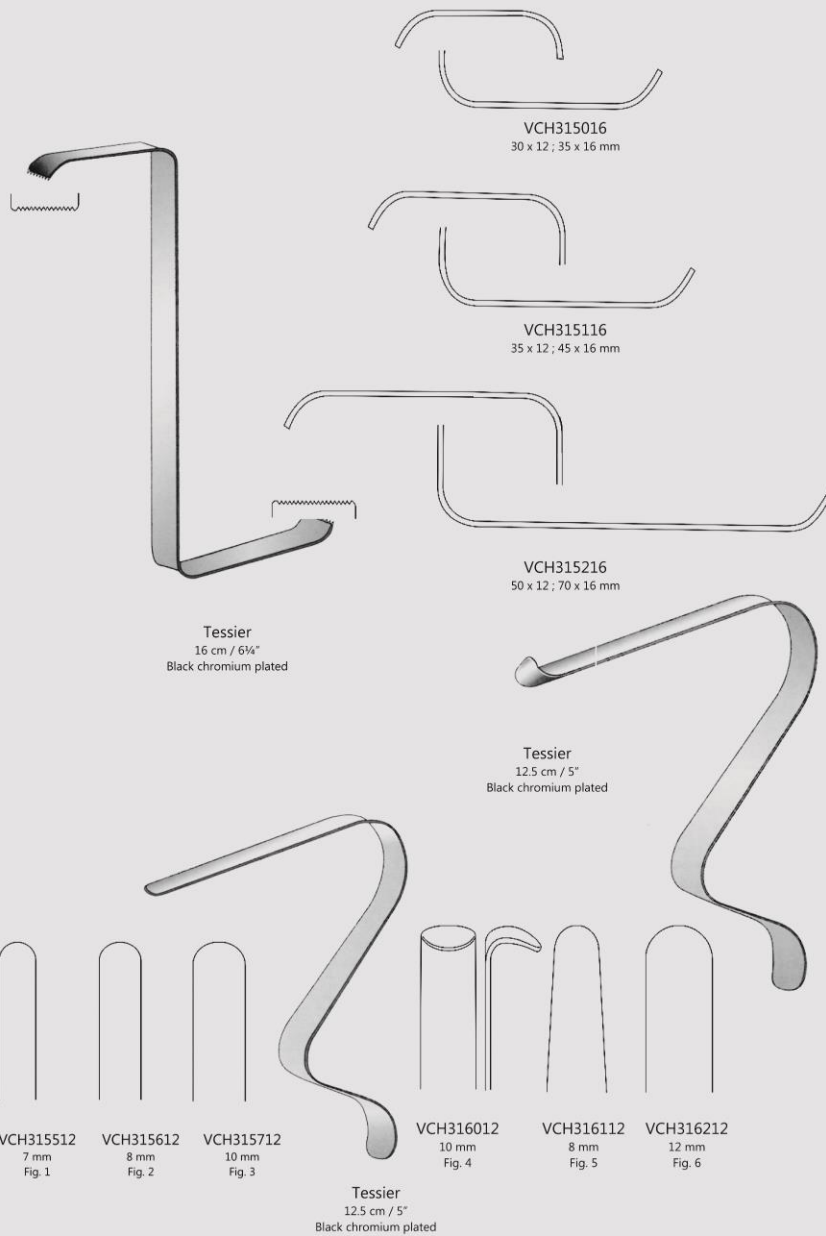
Tessier
15.5 cm / 6"
Black chromium plated



Tessier
15.5 cm / 6"
Black chromium plated



Oral Maxillo-Facial Surgery
Soft Tissue Retractors
Weichteilhaken
Separadores para partes blandas



VCH315016
30 x 12; 35 x 16 mm

VCH315116
35 x 12; 45 x 16 mm

VCH315216
50 x 12; 70 x 16 mm

Tessier
16 cm / 6 3/4"
Black chromium plated

Tessier
12.5 cm / 5"
Black chromium plated

VCH315512
7 mm
Fig. 1

VCH315612
8 mm
Fig. 2

VCH315712
10 mm
Fig. 3

VCH316012
10 mm
Fig. 4

VCH316112
8 mm
Fig. 5

VCH316212
12 mm
Fig. 6

Tessier
12.5 cm / 5"
Black chromium plated

فک و صورت
اکار تورها



CE

SQS Certificate
ISO 9001:2000
ISO 13485:2003





Crano Maxillo-Facial Surgery
Soft Tissue Retractors
Weichteilhaken
Separadores para partes blandas

فک و صورت
اکارتورها



CE

SQS Certificate
ISO 9001:2000
ISO 13485:2003

550



VCH316524
5 x 16 mm

VCH316624
7 x 25 mm

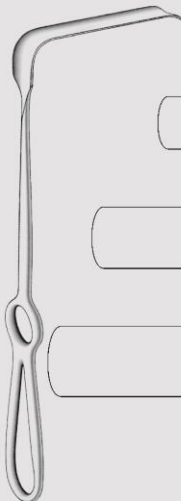
VCH316724
10 x 35 mm

VCH316824
10 x 42 mm

VCH316924
12 x 55 mm

VCH317024
14 x 70 mm

VCH317124
16 x 80 mm



Obwegeser
24 cm / 9½"
Bent downwards



VCH317524
5 x 16 mm

VCH317624
7 x 25 mm

VCH317724
10 x 35 mm

VCH317824
10 x 42 mm

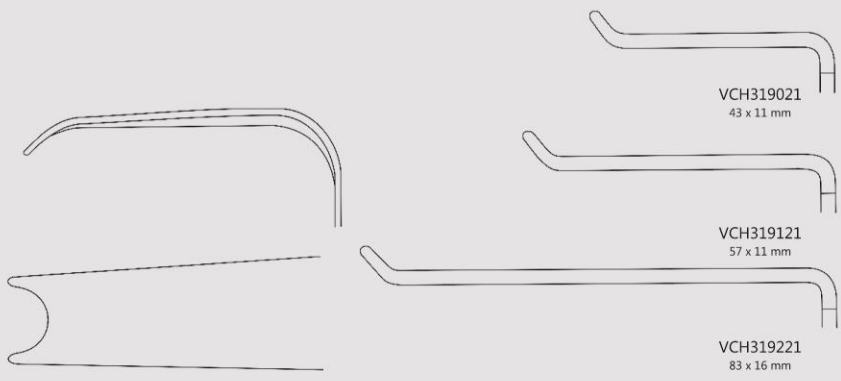
VCH317924
12 x 55 mm

VCH318024
14 x 70 mm

VCH318124
16 x 80 mm



Obwegeser
24 cm / 9½"
Bent upwards



VCH319021
43 x 11 mm

VCH319121
57 x 11 mm

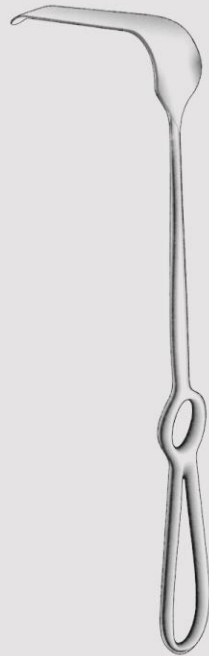
VCH319221
83 x 16 mm



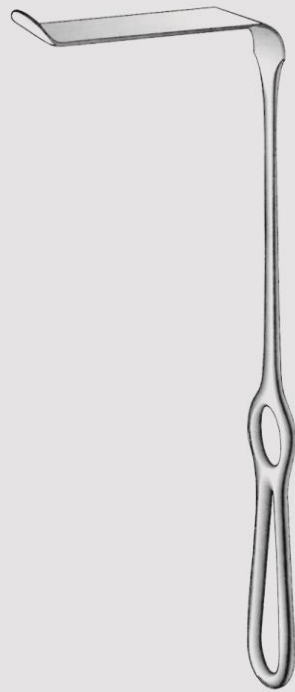
Crano Maxillo-Facial Surgery

Third Molar and Soft
Tissue Retractors
Weisheitszahn Haken
und Weichteilhaken
Separador para muela del
juicio Y para partes blandas

فک و صورت
اکار تورها



Obwegeser
VCH318524
15/22 x 70 mm
24 cm / 9½"
Third molar retractor



Obwegeser
21.5 cm / 8½"



SQS Certificate
ISO 9001:2000
ISO 13485:2003





Oral Maxillo-Facial Surgery
Progeny Retractors
Progeniehaken
Separadores para progenismo

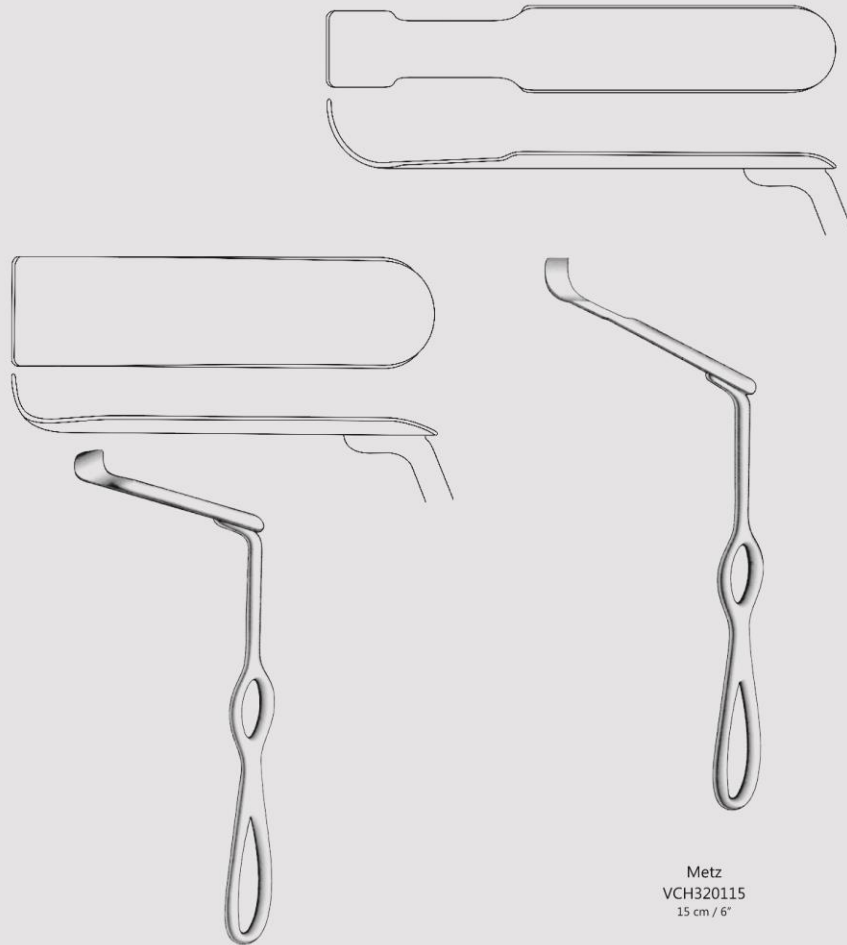
فک و صورت
اکارتورها



CE

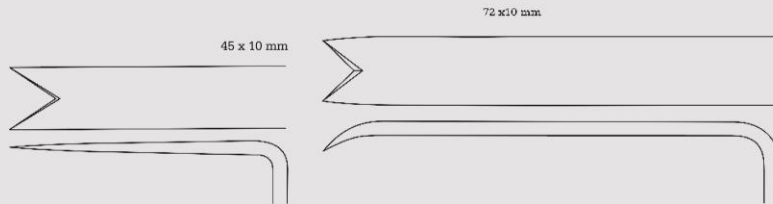
SQS Certificate
ISO 9001:2000
ISO 13485:2003

552



Schuchardt
VCH319515
15 cm / 6"

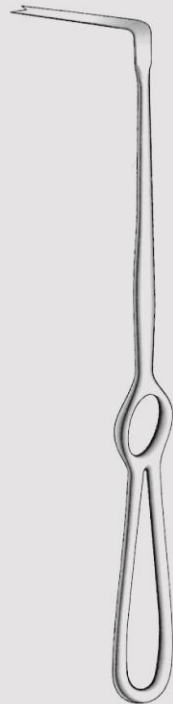
Metz
VCH320115
15 cm / 6"



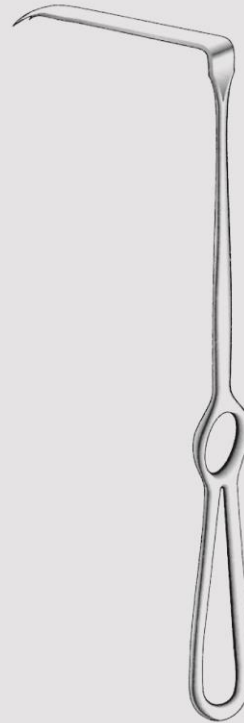
Oral Maxillo-Facial Surgery

Ramus Retractors
Ramushaken
Separadores para el ramo

فک و صورت
اکار تورها



Obwegesser
VCH320522
22 cm / 8 1/4"
Nasal spine retractor



Obwegesser
VCH321022
22 cm / 8 1/4"



CE

SQS Certificate
ISO 9001:2000
ISO 13485:2003





Crano Maxillo-Facial SuRrgery
Ramus and Nasal Spine Retractor
Ramusshaken und Spina nasalis Haken
Separadores para el ramo Y espina nasal

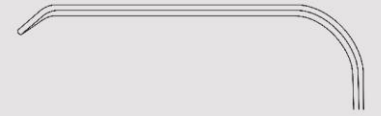
فک و صورت
اکار تورها



CE

SQS Certificate
ISO 9001:2000
ISO 13485:2003

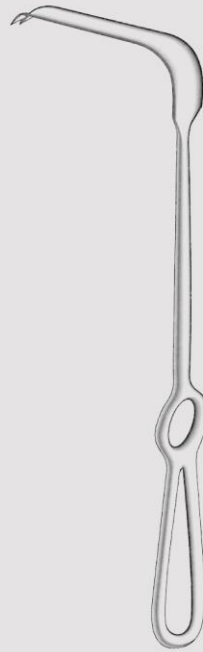
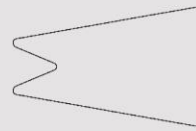
554



VCH321524
11/15 x 70 mm



VCH321624
12/22 x 70 mm



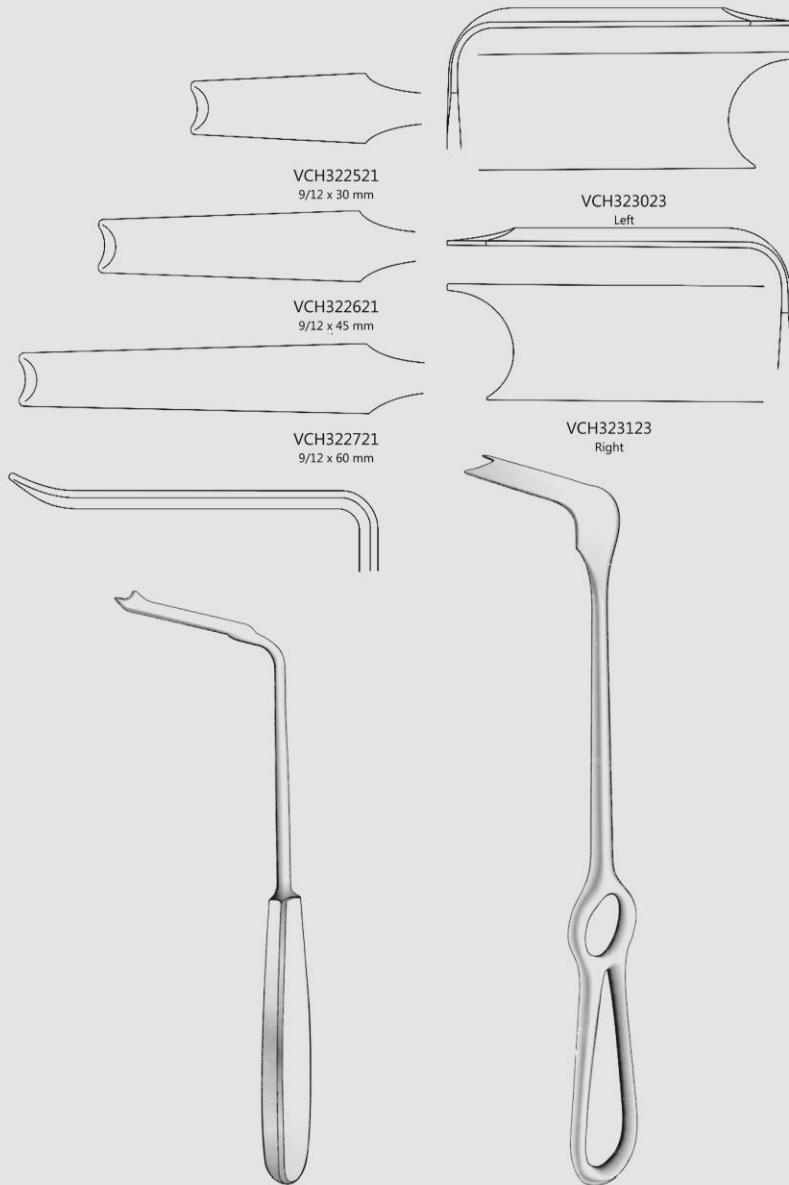
Obwegeser
24.5 cm / 9 3/4"



Obwegeser
VCH322024
24.5 cm / 9 3/4"
10/23 x 40 mm
Nasal spine retractor



Crano Maxillo-Facial Surgery
Mandibular Retractors,
Zygomatic Retractor
Unterkieferhaken,
Zygoma Wundhaken
Separadores mandibulares,
Separador cigomatico



Obwegeser
21 cm / 8¼"

Steinhauser
23 cm / 9"
20 x 50 mm

فک و صورت
اکار تورها



CE

SQS Certificate
ISO 9001:2000
ISO 13485:2003

555



Crano Maxillo-Facial Surgery
 Perform Kim & Ramus Retractors, Mandibular Inferior Border Retractor
 Profunditäts-Haken und Ramushaken, Unterkieferrand Rezipitoren
 Gancho yiforme, Separadores de carne, Legajo para el borde mandibular

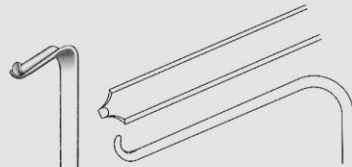
فک و صورت
 اکارتورها



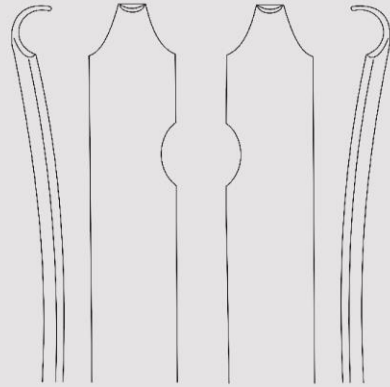
CE

SQS Certificate
 ISO 9001:2000
 ISO 13485:2003

556

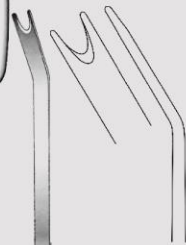


Hargis
VCHB23518
 18.5 cm / 7 1/4"



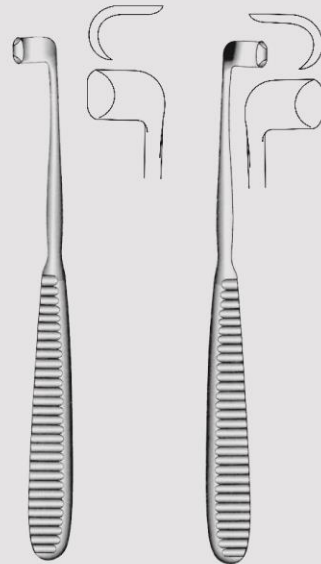
VCHB24019
 Right

VCHB24119
 Left



Terry
VCHB24524
 24 cm / 9 1/2"
 Ramus pusher

Hargis
 19.5 cm / 7 3/4"



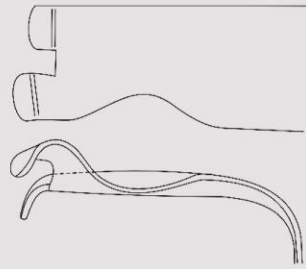
Obwegeser
VCHB25018
 18 cm / 7"
 10 mm
 Angled to left

Obwegeser
VCHB25118
 18 cm / 7"
 10 mm
 Angled to right

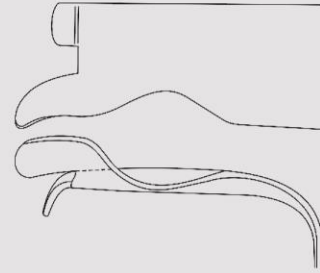


Crano Maxillo-Facial Surgery

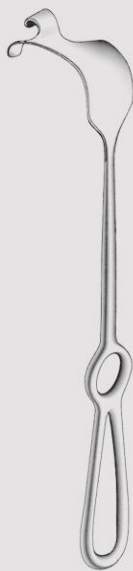
LeFort I Retractors,
Sinus Lift Retractors
LeFort I-Haken,
Sinushaken
Ganchos de LeFort I,
Ganchos para seno



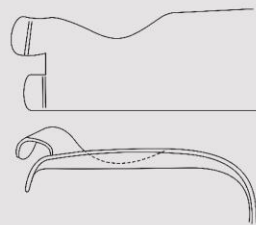
VCH326022
Left



VCH327022
Left



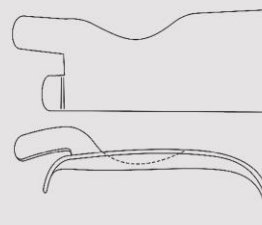
Arnhem
22 cm / 8 3/4"
LeFort I retractor



VCH326522
Right



Arnhem
22 cm / 8 3/4"
Sinus lift retractor



VCH327122
Right

فک و صورت
اکار تورها



SQS Certificate
ISO 9001:2000
ISO 13485:2003

557



Crano Maxillo-Facial Surgery
Mobilizing Retractors, Palatal Expander
Mobilisierhaken, Palatumspreizer
Separadores de mobilización, Separador paladial

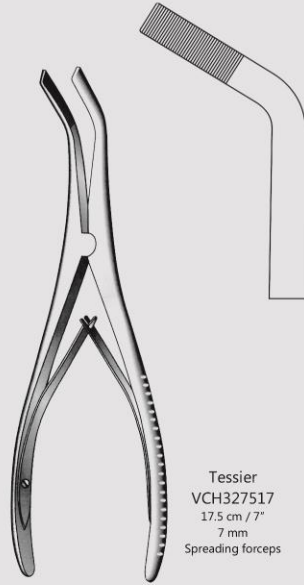
فک و صورت



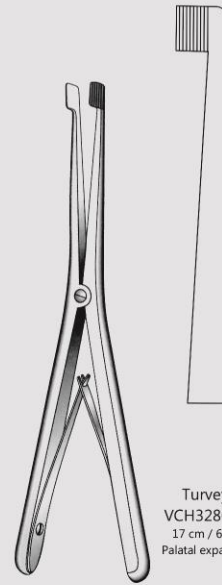
CE

SQS Certificate
ISO 9001:2000
ISO 13485:2003

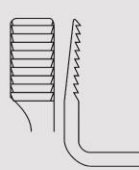
558



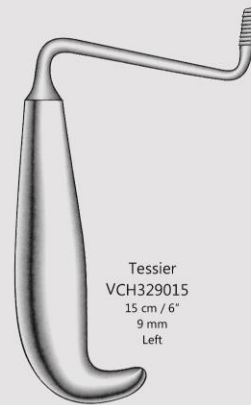
Tessier
VCH327517
17.5 cm / 7"
7 mm
Spreading forceps



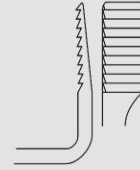
Turvey
VCH328017
17 cm / 6 3/4"
Palatal expander



Tessier
VCH328515
15 cm / 6"
9 mm
Right



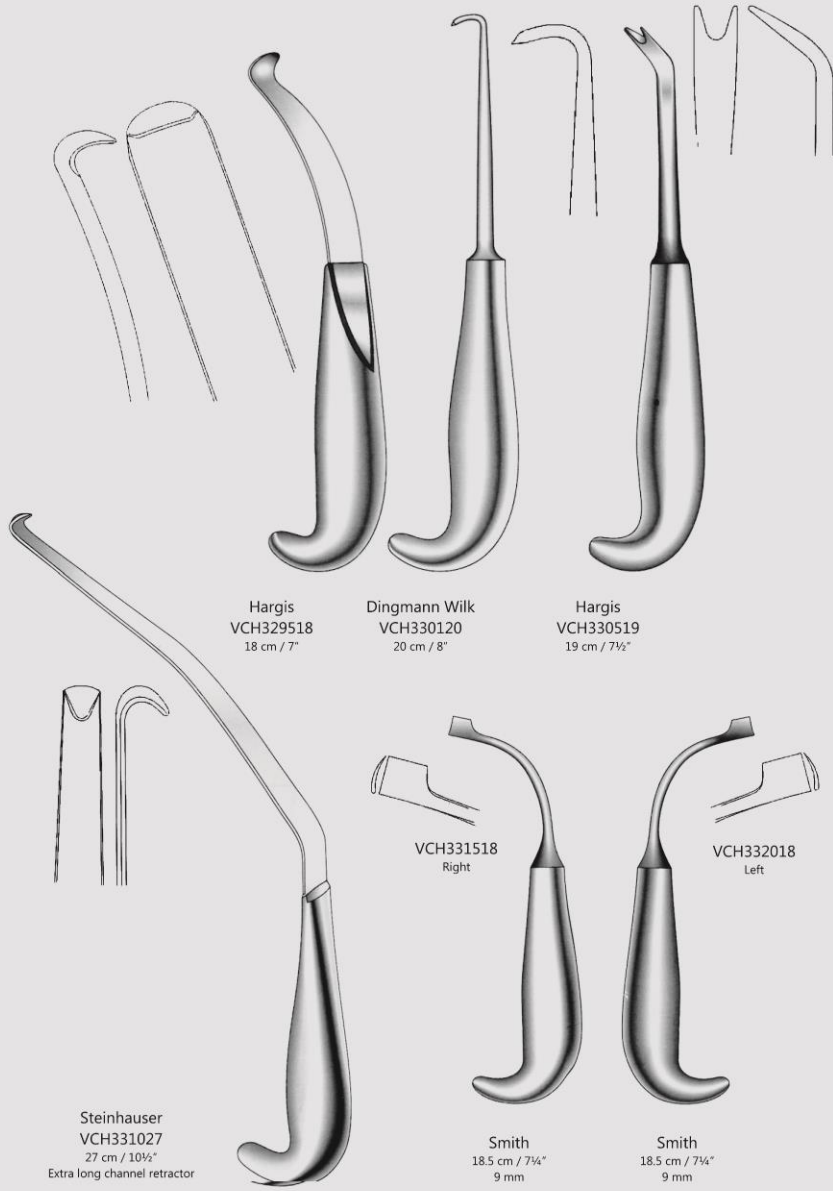
Tessier
VCH329015
15 cm / 6"
9 mm
Left





Crano Maxillo-Facial Surgery

Mandibular Body Retractor,
Anterior Border Stripper,
Sagittal Split Separators
Unterkieferkorperhaken,
Vorderrandstripper,
Sagittalspreizer
Separador para el cuerpo
mandibular Y el borde anteriore,
para Sagitales



فک و صورت
اکار تورها



SQS Certificate
ISO 9001:2000
ISO 13485:2003





Crano Maxillo-Facial Surgery
Intra Oral Retractors
Intraorale Retraktoren
Separadores intra orales

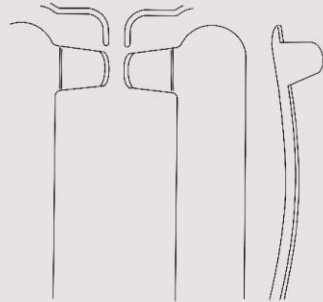
فک و صورت
اکارتورها



CE

SQS Certificate
ISO 9001:2000
ISO 13485:2003

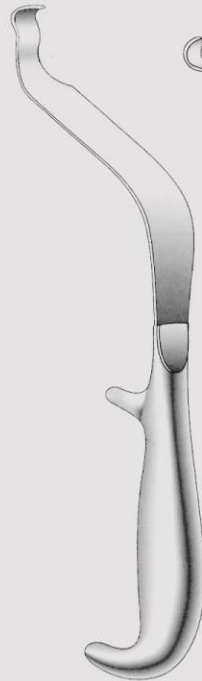
560



VCH332521
21 cm / 8¼"
26.5 / 16 mm
Right



VCH333021
21 cm / 8¼"
26.5 / 16 mm
Left



VCH333525
25 cm / 9¾"
12.5 / 27 mm
L&M. for vertical osteotomy



VCH334022
22 cm / 8¼"
9.5 / 16 mm
Concave blade, fully bent tip
Extra oral retractor
with fiber optic light carrier



VCH334523
23 cm / 9"
25.5 mm
For LeFort osteotomies
with fiber optic light carrier



Crano Maxillo
Facial Surgery
Intra Oral Retractors
Intraorale Retraktoren
Separadores intra orales



VCH335028
28 cm / 11"
12.5 / 27 mm
L&M, for vertical osteotomy
with fiber optic light carrier

Shea
VCH335522
22 cm / 8 3/4"
14.5 mm
Multi purpose retractor
with fiber optic light carrier

VCH336024
24.5 cm / 9 3/4"
26.5 / 16 mm
Right
with fiber optic light carrier

VCH336524
24.5 cm / 9 3/4"
26.5 / 16 mm
Left
with fiber optic light carrier

فک و صورت
اکار توورها



SQS Certificate
ISO 9001:2000
ISO 13485:2003

561



Crano Maxillo-Facial Surgery
Oral Retractors
Orale Retraktoren
Separadores orales

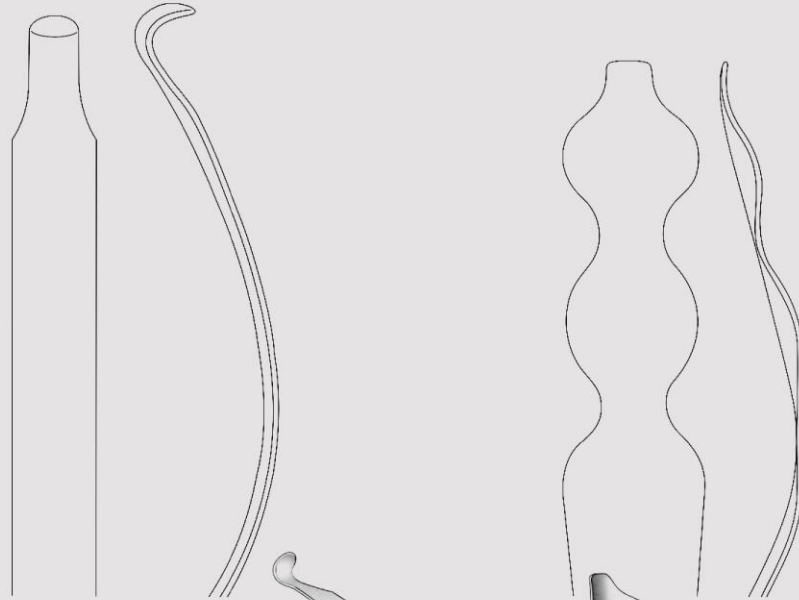
فک و صورت
اکارتورها



CE

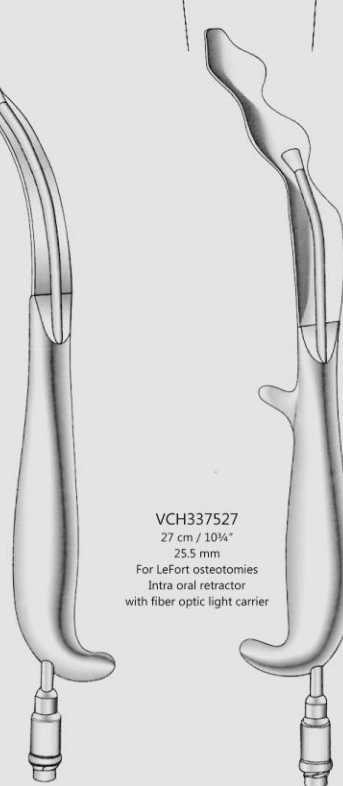
SQS Certificate
ISO 9001:2000
ISO 13485:2003

562



VCH337025
25.5 cm / 10"
9.5 / 16 mm
Concave blade, fully bent tip
Extra oral retractor
with fiber optic light carrier

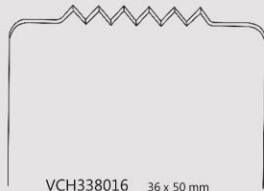
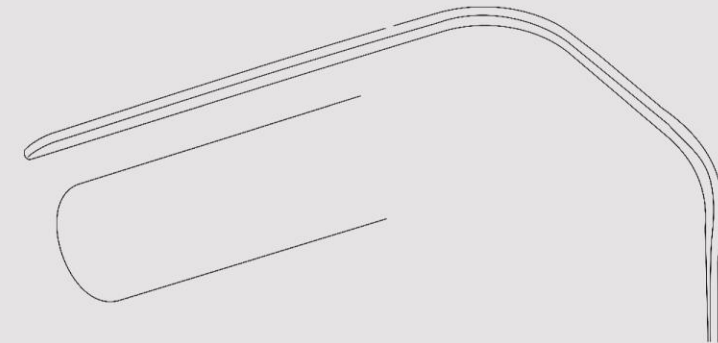
VCH337527
27 cm / 10 3/4"
25.5 mm
For LeFort osteotomies
Intra oral retractor
with fiber optic light carrier



www.Diamondmed.ir



Crano Maxillo-
Facial Surgery
Iliac Crest Retractors,
Thoracic Retractors
Beckenkammspatel,
Thoraxhaken
Separadores para cresta iliaca,
Separadores toracico



VCH338016 36 x 50 mm
VCH338116 52 x 50 mm
VCH338216 59 x 50 mm
VCH338316 66 x 50 mm



Tessier
16 cm / 6¼"
Black chromium plated



Tessier
VCH338520 90 x 22 mm
VCH338620 120 x 28 mm
20.5 cm / 8"
Black chromium plated

فک و صورت
اکارتورها



CE

SQS Certificate
ISO 9001:2000
ISO 13485:2003

563



Tonsil
Tonsil Needles
Tonsillennadeln
Agujas para suturas de amigdalas

لوزه سوزن



CE
SQS Certificate
ISO 9001:2000
ISO 13485:2003

564



Hurd
VCI300121
21 cm / 8 1/4"
For right hand

Hurd
VCI300521
21 cm / 8 1/4"
For left hand

Durham
VCI301025
25 cm / 10"

Durham
VCI301525
25 cm / 10"

Dupuy-Weiss
VCI302022
22 cm / 8 3/4"

Dupuy-Weiss
VCI302522
22 cm / 8 3/4"



Tonsil
Tonsil Knives
Tonsillenmesser
Bisturies para amígdalas



Douglas
VCI303021
21 cm / 8¼"

Colver
VCI303522
22.5 cm / 9"

Fisher
VCI304022
22.5 cm / 9"

Day
VCI304521
21.5 cm / 8½"

Abraham
VCI305021
21.5 cm / 8½"

Canfield
VCI305521
21 cm / 8¼"

Tyding
VCI306021
21 cm / 8¼"

Lynch
VCI306520
20 cm / 8"

لوزه
چاقوها



CE

SQS Certificate
ISO 9001:2000
ISO 13485:2003

565



Tonsil

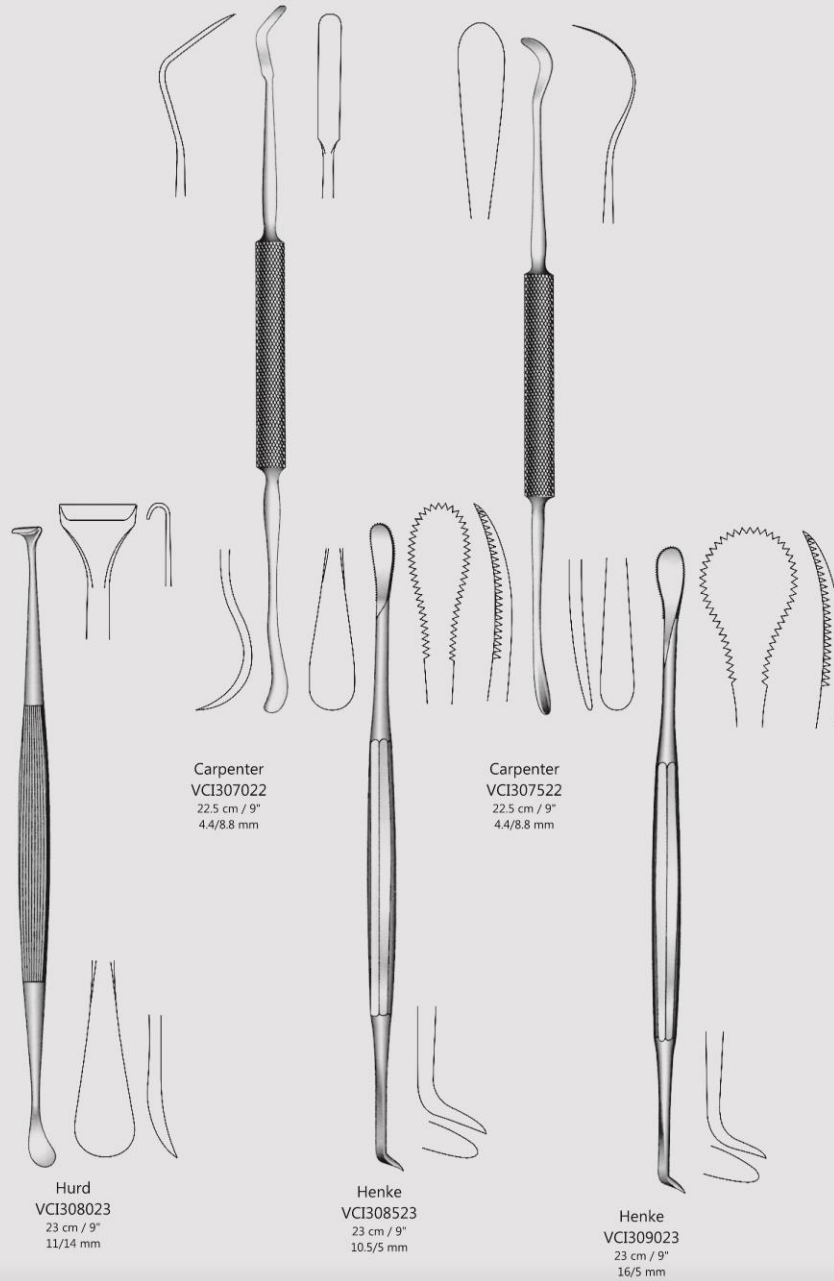
Tonsil Knives, Dissectors, Enucleator, Packer, Retractors
Tonsillenmesser, Dissektoren, Enukleator, Retraktor, usw.
Bisturios, Disecadores, Enucleador, Separador etc.

لوزه
دایسکتورها



SQS Certificate
ISO 9001:2000
ISO 13485:2003

566



Carpenter
VCI307022
22.5 cm / 9"
4.4/8.8 mm

Carpenter
VCI307522
22.5 cm / 9"
4.4/8.8 mm

Hurd
VCI308023
23 cm / 9"
11/14 mm

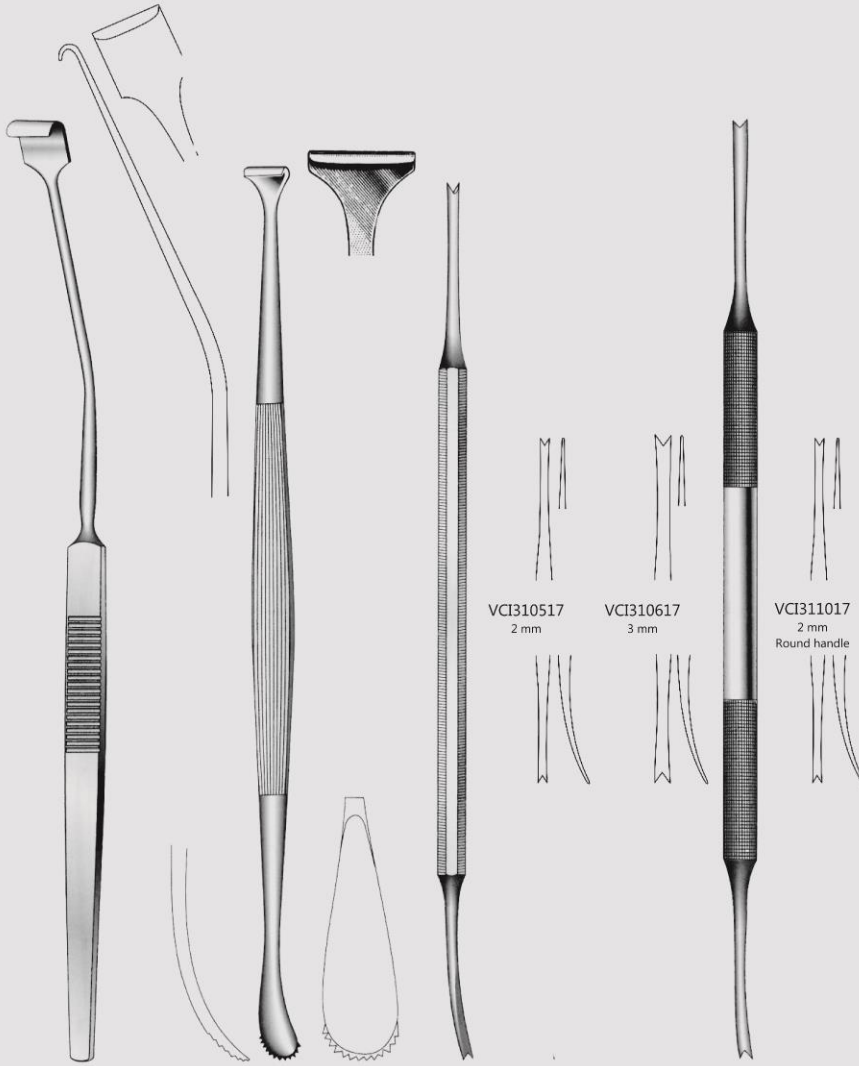
Henke
VCI308523
23 cm / 9"
10.5/5 mm

Henke
VCI309023
23 cm / 9"
16/5 mm



Tonsil

Dissectors, Retractors,
Gauze Packers
Dissektoren, Wundhaken,
Tamponstopfer
Disecadores, Separadore,
Taponeadores



Nager
VCI309524
24 cm / 9½"

Hurd
VCI310122
22 cm / 8¾"
10 x 12 mm wide
Throat retractors and dissector

Luniatschek
17.5 cm / 7"

VCI310517
2 mm

VCI310617
3 mm

VCI311017
2 mm
Round handle

Luniatschek
17.5 cm / 7"

لوزه
داسیکتورها



SQS Certificate
ISO 9001:2000
ISO 13485:2003





Tonsil

Tonsil Haemostatic and Abscess Forceps
Tonsillen-Klemmzangen und Abszesszangen
Pinzas hemostáticas y Lanceta p/ abscesos

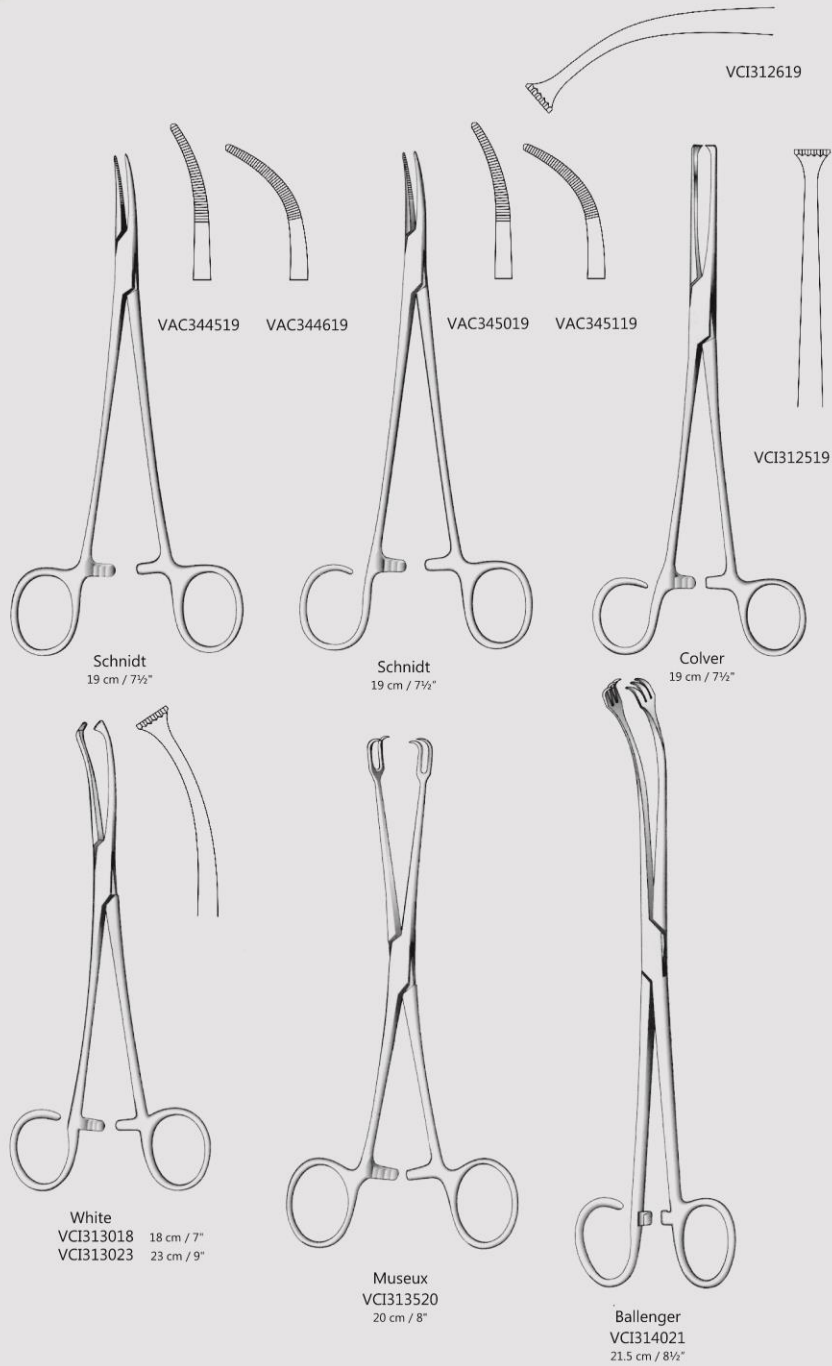
لوزه
پنس ها



CE

SQS Certificate
ISO 9001:2000
ISO 13485:2003

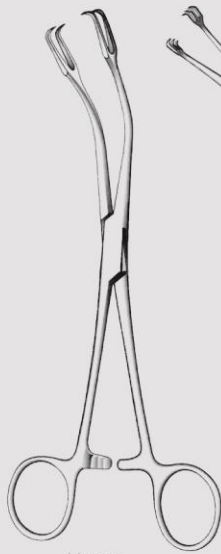
568



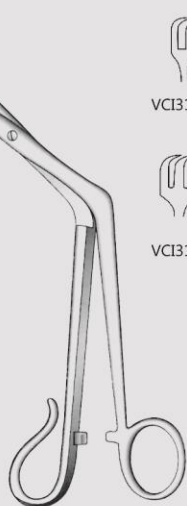


Tonsil

Tonsil Seizing Forceps
Tonsillenzangen
Pinzas para coger las amígdalas



Museux
VCI314520
20 cm / 8"



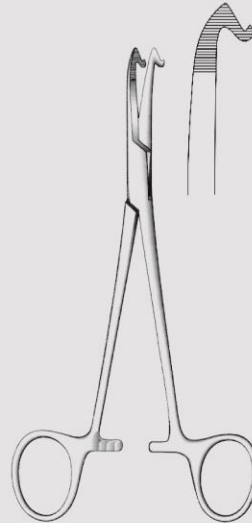
Tivnen-Tyding
21 cm / 8¼"



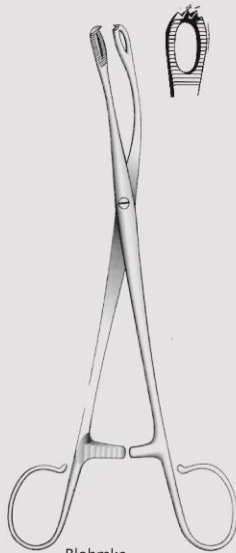
VCI315021



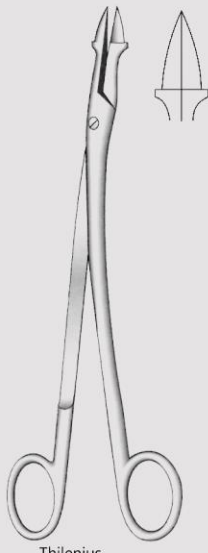
VCI315121



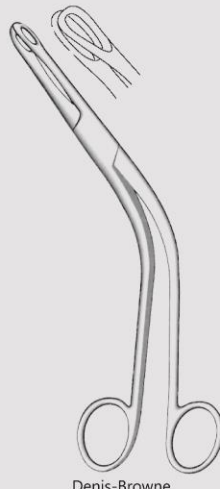
McWhofter-Lothrop
VCI315518
18 cm / 7"



Blohmke
VCI316020
20 cm / 8"



Thilenius
VCI316520
20 cm / 8"



Denis-Browne
VCI317018
18 cm / 7"

لوزه
پنس ها



CE

SQS Certificate
ISO 9001:2000
ISO 13485:2003

569



Tonsil
Tonsil Snares
Tonsillenschnurer
Cierra. Nudos para amígdalas

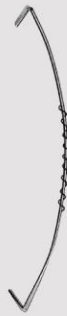
لوزه
سرنو



CE

SQS Certificate
ISO 9001:2000
ISO 13485:2003

570

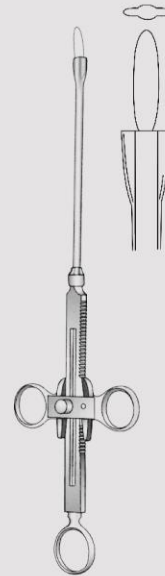


VCI317500
0.3 mm \varnothing

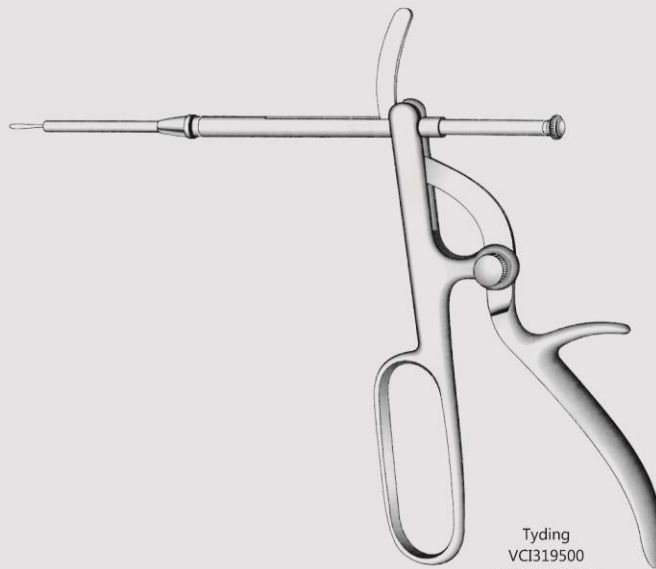
Eves
VCI318028
28 cm / 11"



Eves
VCI318528
28 cm / 11"



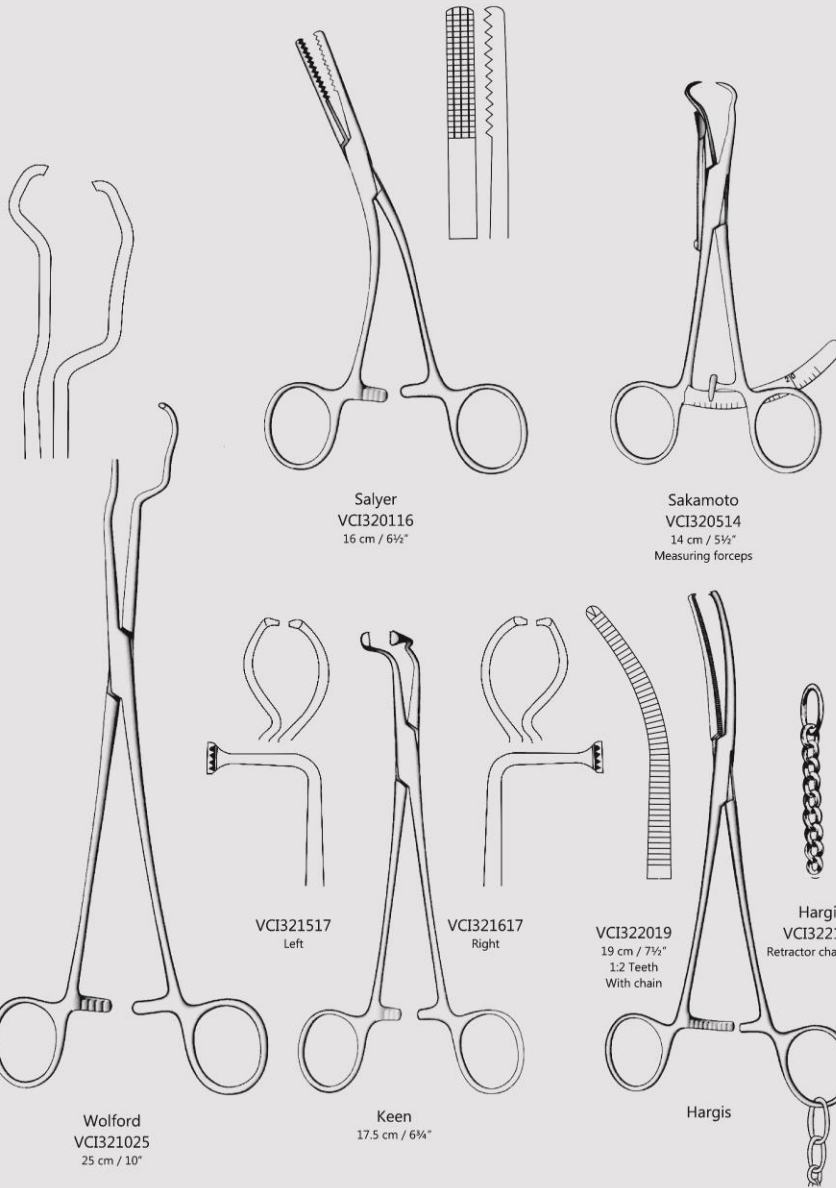
Bruenings
VCI319028
28 cm / 11"



Tyding
VCI319500
With one straight tip



Tonsil
 Bone Holding Forceps
 Knochenhaltezangen
 Pinzas para huesos



Salyer
 VCI320116
 16 cm / 6½"

Sakamoto
 VCI320514
 14 cm / 5½"
 Measuring forceps

VCI321517
 Left

VCI321617
 Right

VCI322019
 19 cm / 7½"
 1.2 Teeth
 With chain

Hargis
 VCI322100
 Retractor chain, only

Wolford
 VCI321025
 25 cm / 10"

Keen
 17.5 cm / 6¾"

Hargis

لوزه
 پنس ها



CE

SQS Certificate
 ISO 9001:2000
 ISO 13485:2003

571



Tonsil
Tonsillectomies
Tonsillotome
Amigdalotomos

لوزه
پنس ها



CE
SQS Certificate
ISO 9001:2000
ISO 13485:2003

572



VCI322512
13 mm Ø
Cut
Through cut

VCI322612
15 mm Ø
Cut
Through cut

VCI322712
17 mm Ø
Cut
Through cut



Hartmann
12 cm / 4 3/4"

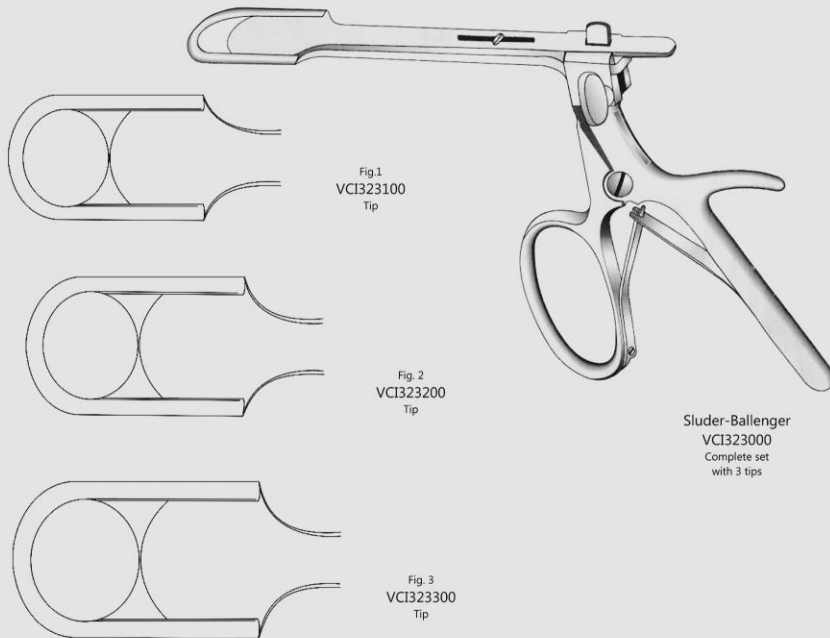


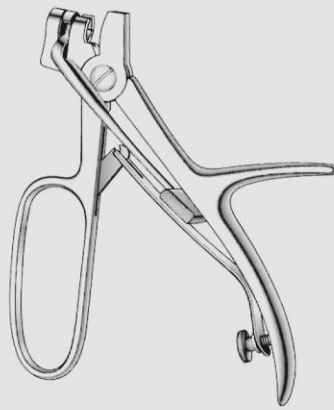
Fig.1
VCI323100
Tip

Fig. 2
VCI323200
Tip

Fig. 3
VCI323300
Tip

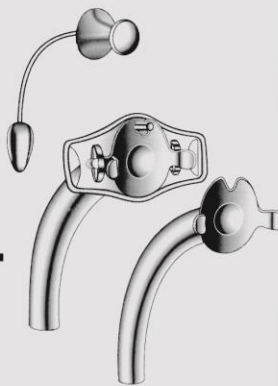
Sluder-Ballenger
VCI323000
Complete set
with 3 tips

DIAMOND SURGICAL
WWW.DIAMONDMED.IR INSTRUMENTS



VCI

VBG



Esophagoscopy

Trachetomy



CE

SQS Certificate
ISO 9001:2000
ISO 13485:2003

573

www.Diamondmed.ir

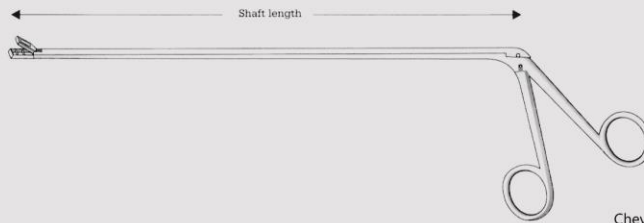


Esophagoscopy

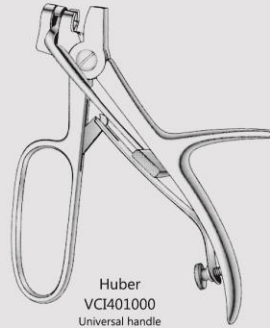
Broncho-Esophagoscopy Forceps
Broncho-Oesophagoskopiezangen
Pinzas para bronco-esofagoscopia



Shaft length	VCI400130	VCI400230	VCI400330	VCI400430	VCI400530	VCI400630	VCI400730
30 cm / 12"	VCI400130	VCI400230	VCI400330	VCI400430	VCI400530	VCI400630	VCI400730
40 cm / 16"	VCI400140	VCI400240	VCI400340	VCI400440	VCI400540	VCI400640	VCI400740
50 cm / 20"	VCI400150	VCI400250	VCI400350	VCI400450	VCI400550	VCI400650	VCI400750
60 cm / 24"	VCI400160	VCI400260	VCI400360	VCI400460	VCI400560	VCI400660	VCI400760

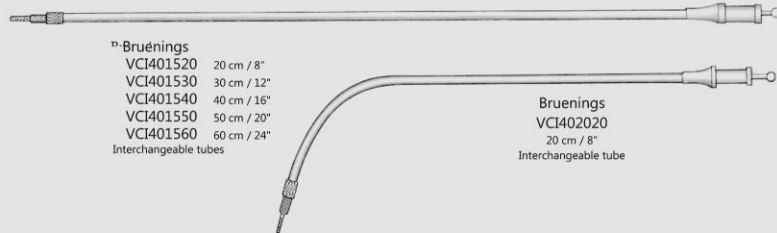


Chevalier-Jackson
Chevalier-Jackson



Huber
VCI401000
Universal handle

حنجره
پنس ها



™-Bruenings
 VCI401520 20 cm / 8"
 VCI401530 30 cm / 12"
 VCI401540 40 cm / 16"
 VCI401550 50 cm / 20"
 VCI401560 60 cm / 24"
 Interchangeable tubes

Bruenings
 VCI402020
 20 cm / 8"
 Interchangeable tube

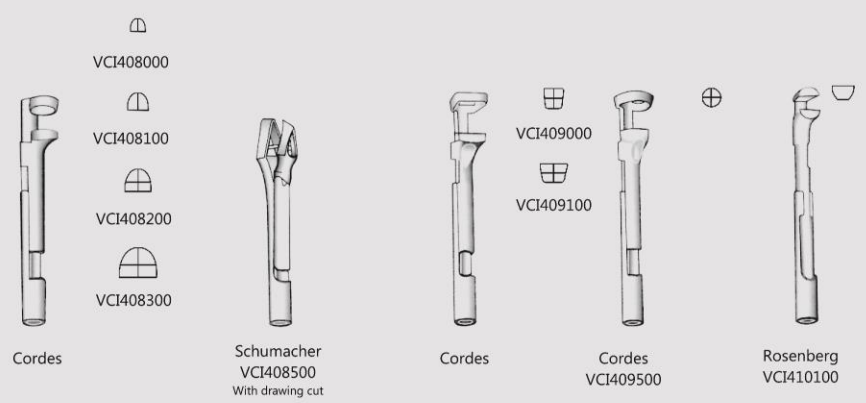
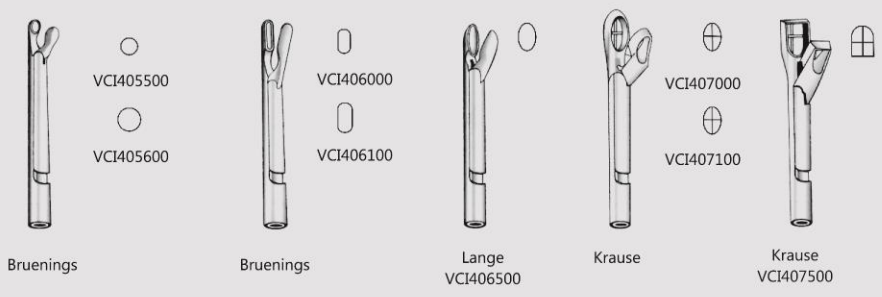
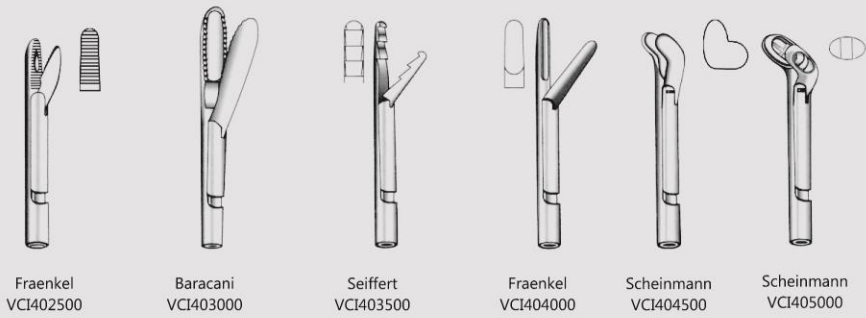
CE

SQS Certificate
ISO 9001:2000
ISO 13485:2003

574



Esophagoscopy
Exchangeable Tips
Auswechselbare Zangenaufsätze
Pinzas intercambiables



حنجره
پنس ها



CE
SQS Certificate
ISO 9001:2000
ISO 13485:2003





Esophagoscopy
Laryngeal Mirrors and Handles
Kehlkopfspiegel und Griffe
Espejos laringeos y Mangos

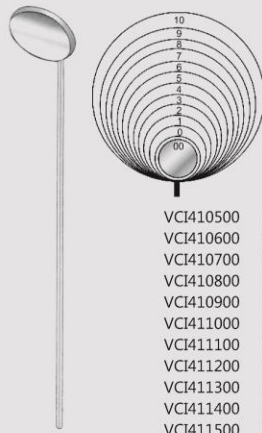
حنجره
آيينه حنجره



CE

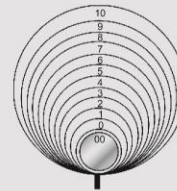
SQS Certificate
ISO 9001:2000
ISO 13485:2003

576



13.5 cm / 5 3/4"
Plane, without handle
Rhodium handle

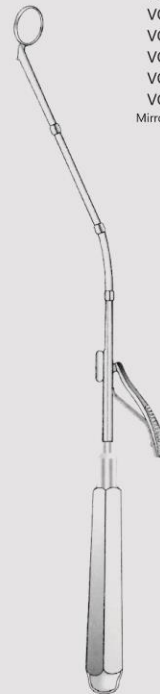
- VCI410500 Fig. 00 = 8 mm \varnothing
- VCI410600 Fig. 0 = 10 mm \varnothing
- VCI410700 Fig. 1 = 12 mm \varnothing
- VCI410800 Fig. 2 = 14 mm \varnothing
- VCI410900 Fig. 3 = 16 mm \varnothing
- VCI411000 Fig. 4 = 18 mm \varnothing
- VCI411100 Fig. 5 = 20 mm \varnothing
- VCI411200 Fig. 6 = 22 mm \varnothing
- VCI411300 Fig. 7 = 24 mm \varnothing
- VCI411400 Fig. 8 = 26 mm \varnothing
- VCI411500 Fig. 9 = 28 mm \varnothing
- VCI411600 Fig. 10 = 30 mm \varnothing



- VCI412000 Fig. 00 = 8 mm \varnothing
- VCI412100 Fig. 0 = 10 mm \varnothing
- VCI412200 Fig. 1 = 12 mm \varnothing
- VCI412300 Fig. 2 = 14 mm \varnothing
- VCI412400 Fig. 3 = 16 mm \varnothing
- VCI412500 Fig. 4 = 18 mm \varnothing
- VCI412600 Fig. 5 = 20 mm \varnothing
- VCI412700 Fig. 6 = 22 mm \varnothing
- VCI412800 Fig. 7 = 24 mm \varnothing
- VCI412900 Fig. 8 = 26 mm \varnothing
- VCI413000 Fig. 9 = 28 mm \varnothing
- VCI413100 Fig. 10 = 30 mm \varnothing



18.5 cm / 7 3/4"
Plane, with fixed handle
Rhodium handle

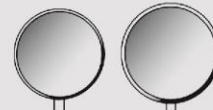


Michel
25 cm / 10"
Moveable mirror



VCI414525
12 mm \varnothing
Fig. 1

VCI414625
14 mm \varnothing
Fig. 2

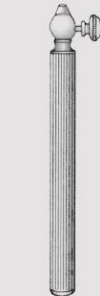


VCI414725
16 mm \varnothing
Fig. 3

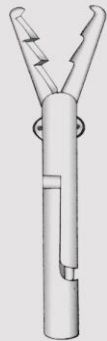
VCI414825
18 mm \varnothing
Fig. 4



VCI413500
10 cm / 4"



VCI414000
10 cm / 4"



Kahler
VCI415040
40 cm / 16"
Tip 4 mm



VCI415530
30 cm / 12"
Tip 7 mm



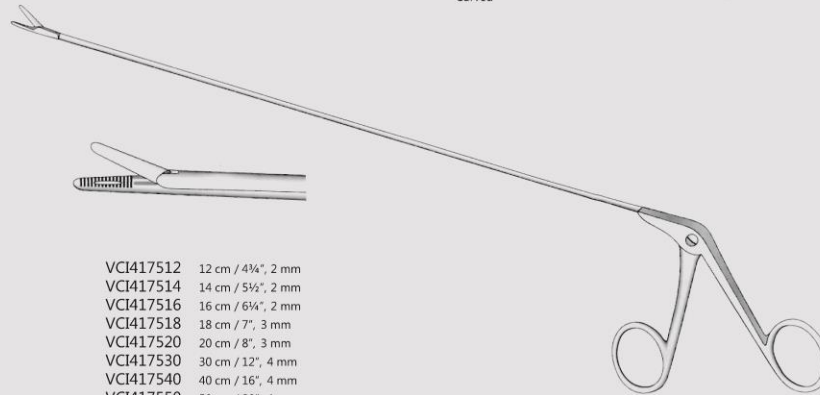
Papilloma
VCI416030
30 cm / 12"
Tip 7 mm



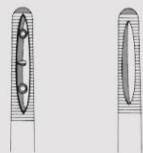
Jackson
VCI416530 30 cm / 12", 2 mm
Straight
VCI416630 30 cm / 12", 4 mm
Curved



Jackson
VCI417030
30 cm / 12", 4 mm
Angled



VCI417512 12 cm / 4 3/4", 2 mm
VCI417514 14 cm / 5 1/2", 2 mm
VCI417516 16 cm / 6 1/4", 2 mm
VCI417518 18 cm / 7", 3 mm
VCI417520 20 cm / 8", 3 mm
VCI417530 30 cm / 12", 4 mm
VCI417540 40 cm / 16", 4 mm
VCI417550 50 cm / 20", 4 mm



VCI418024 1 x 2 Teeth
VCI418124 Without teeth



Jackson
24 cm / 9 1/2"



Esophagoscopy
Laryngeal Polypus Forceps,
Epiglottis Retractor
Kehlkopfpolypenzangen,
Deckelhalter
Pinzas para polipos laringeos,
depressor para epiglottis

حنجره
پنس ها



CE

SQS Certificate
ISO 9001:2000
ISO 13485:2003

577



Esophagoscopy
Laryngeal Polypus Forceps
Kehlkopfpolypenzangen
Pinzas para polipos laringeos

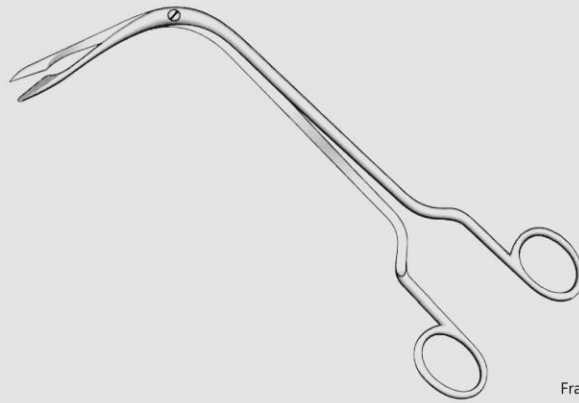
حنجره
پنس ها



CE

SQS Certificate
ISO 9001:2000
ISO 13485:2003

578



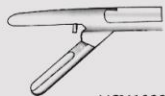
Fraenkel
VCI418523
23 cm / 9"



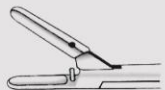
VCI419023



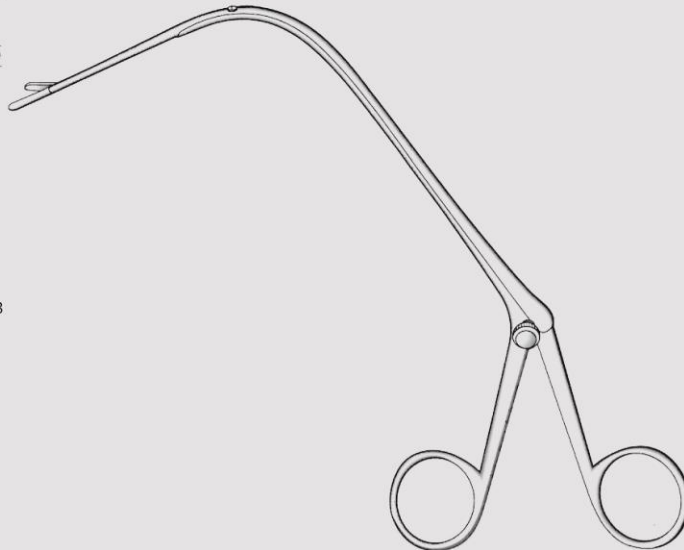
VCI419123



VCI419223



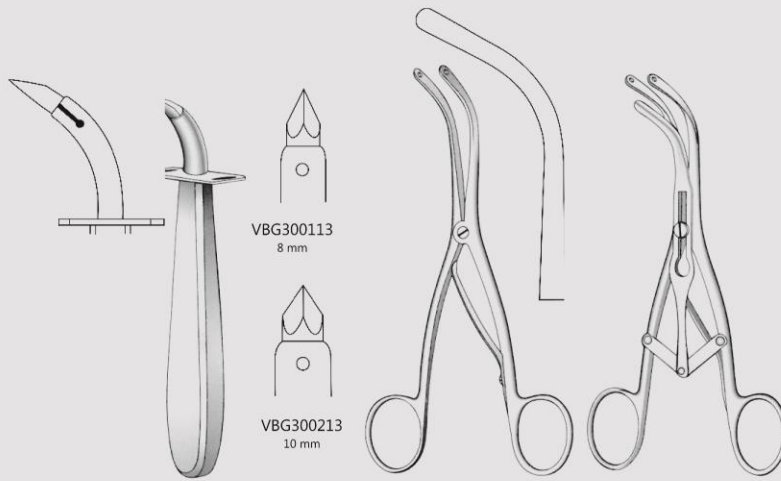
VCI419323



Jurasz
23 cm / 9"



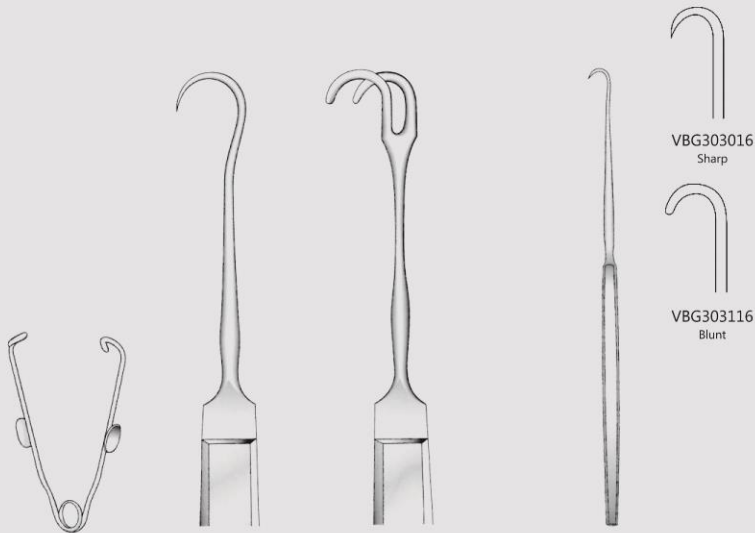
Tracheotomy
Trachea Trocars and Dilators,
Trachea Retractors
Tracheal-Trokare und Dilatatore,
Tracheal Hakchen
Traquo tomos Y Dilatadores,
Separadores prala traquea



Uckermann
13 cm / 5"
Hollow handle

Trousseau
VBG300514
14 cm / 5 1/2"

Laborde
VBG301014
14 cm / 5 1/2"



Bose
VBG301507
7 cm / 2 3/4"

VBG302018
18 cm / 7"

VBG302518
18 cm / 7"

Iterson
16 cm / 6 3/4"

VBG303016
Sharp

VBG303116
Blunt

تراکستومی
اکار تور



CE

SQS Certificate
ISO 9001:2000
ISO 13485:2003

579



Tracheotomy
Tracheal Hooks
Trachealhaken
Ganchos traqueales

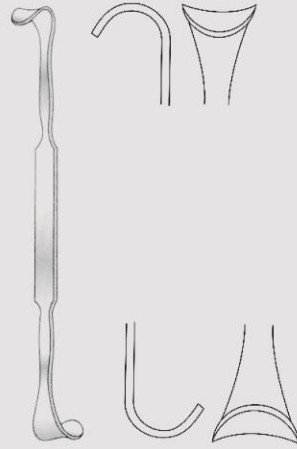
تراکستومی
هوک ها



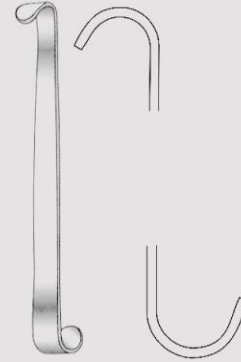
CE

SQS Certificate
ISO 9001:2000
ISO 13485:2003

580



Rose
VBG303513
13 cm / 5"



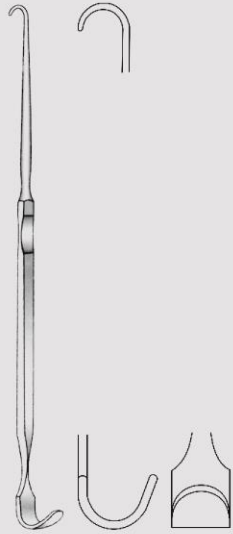
Luer
VBG304011
11 cm / 4 1/4"



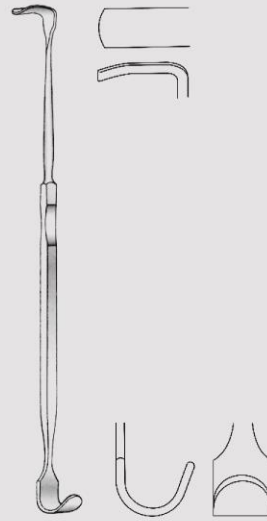
Jackson
VBG304515
15 cm / 6"



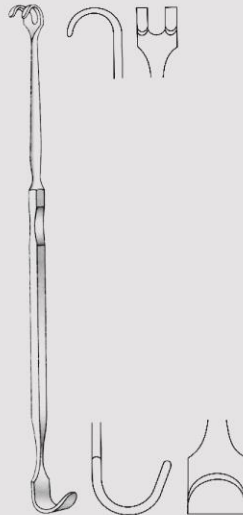
Tracheotomy
Trachea Retractors and Hooks
Tracheal Hakchen und Haken
Separadores para traquea Y Ganchos traqueales



Jackson
VBG305018
18 cm / 7"



Lukens
VBG305517
17 cm / 6 1/4"



Jackson
VBC306017
17 cm / 6 1/4"

تراکستومی
اکار تور



CE

SQS Certificate
ISO 9001:2000
ISO 13485:2003

581



Tracheotomy
Trachea Tubes
Tracheal-Kenulen
Canulas traqueales

لوله تراکستومی



CE

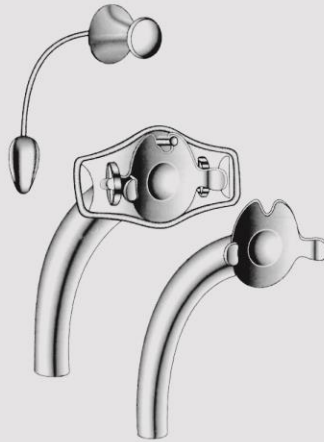
SQS Certificate
ISO 9001:2000
ISO 13485:2003

582

Diameter
Length of outer tube



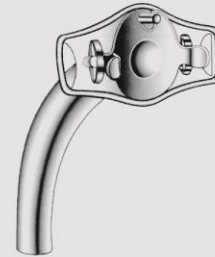
4 mm \emptyset	5 mm \emptyset	6 mm \emptyset	7 mm \emptyset	8 mm \emptyset	9 mm \emptyset	10 mm \emptyset	11 mm \emptyset	12 mm \emptyset	13 mm \emptyset
45 mm	50 mm	55 mm	60 mm	65 mm	70 mm	75 mm	80 mm	85 mm	90 mm
Fig. 0	Fig. 1	Fig. 2	Fig. 3	Fig. 4	Fig. 5	Fig. 6	Fig. 7	Fig. 8	Fig. 9



Chevalier-Jackson

Outer tube closed
Inner tube closed

	Fig.	\emptyset
VBG306500	0	4 mm
VBG306600	1	5 mm
VBG306700	2	6 mm
VBG306800	3	7 mm
VBG306900	4	8 mm
VBG307000	5	9 mm
VBG307100	6	10 mm
VBG307200	7	11 mm
VBG307300	8	12 mm
VBG307400	9	13 mm



Luer

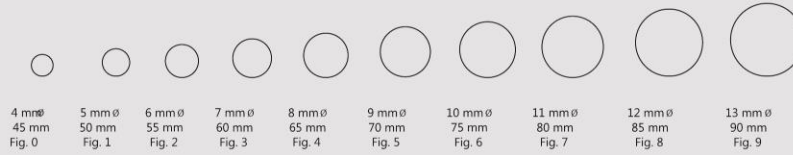
Outer tube sieve
Inner tube sieve

	Fig.	\emptyset
VBG308000	0	4 mm
VBG308100	1	5 mm
VBG308200	2	6 mm
VBG308300	3	7 mm
VBG308400	4	8 mm
VBG308500	5	9 mm
VBG308600	6	10 mm
VBG308700	7	11 mm
VBG308800	8	12 mm
VBG308900	9	13 mm



Tracheotomy
Trachea Tubes
Tracheal-Kenulen
Canulas traqueales

Diameter
Length of outer tube



لوله تراکستومی



Krishaber

Fig.	\emptyset
VBG309500	0 4 mm
VBG309600	1 5 mm
VBG309700	2 6 mm
VBG309800	3 7 mm
VBG309900	4 8 mm
VBG310000	5 9 mm
VBG310100	6 10 mm
VBG310200	7 11 mm
VBG310300	8 12 mm

Krishaber-Luer

Fig.	\emptyset
VBG310500	0 4 mm
VBG310600	1 5 mm
VBG310700	2 6 mm
VBG310800	3 7 mm
VBG310900	4 8 mm
VBG311000	5 9 mm
VBG311100	6 10 mm
VBG311200	7 11 mm
VBG311300	8 12 mm

Parker

Fig.	\emptyset
VBG312000	1 16 mm
VBG312100	2 18 mm
VBG312200	3 20 mm
VBG312300	4 22 mm
VBG312400	5 24 mm
VBG312500	6 26 mm
VBG312600	7 28 mm
VBG312700	8 30 mm
VBG312800	9 32 mm



SQS Certificate
ISO 9001:2000
ISO 13485:2003

583



Tracheotomy
Trachea Tubes
Tracheal-Kenulen
Canulas traqueales

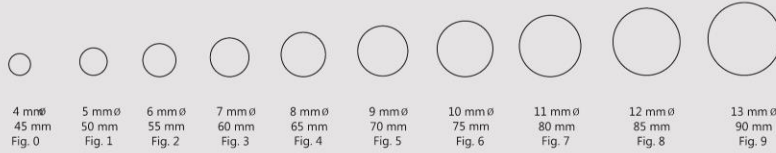
لوله تراکستومی



SQS Certificate
ISO 9001:2000
ISO 13485:2003

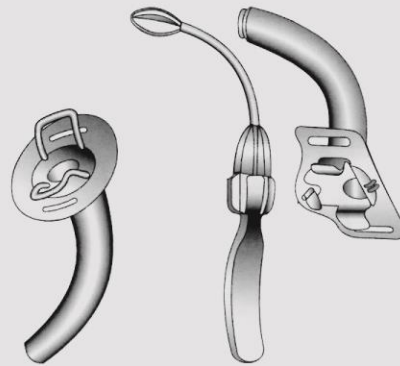
584

Diameter
Length of outer tube



Collin

Fig.	ø
VBG313000	0 4 mm
VBG313100	1 5 mm
VBG313200	2 6 mm
VBG313300	3 7 mm
VBG313400	4 8 mm
VBG313500	5 9 mm
VBG313600	6 10 mm
VBG313700	7 11 mm
VBG313800	8 12 mm



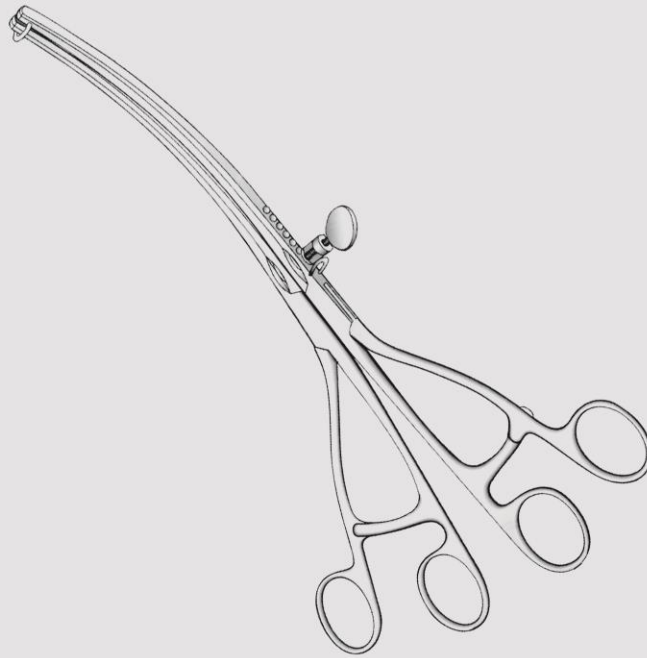
Fuller

Fig.	ø
VBG314000	1 18 mm
VBG314100	2 20 mm
VBG314200	3 22 mm
VBG314300	4 24 mm
VBG314400	5 26 mm
VBG314500	6 28 mm
VBG314600	7 30 mm
VBG314700	8 32 mm

Cubley

Fig.	ø
VBG315000	1 16 mm
VBG315100	2 18 mm
VBG315200	3 20 mm
VBG315300	4 22 mm
VBG315400	5 24 mm
VBG315500	6 26 mm
VBG315600	7 28 mm
VBG315700	8 30 mm
VBG315800	9 32 mm

DIAMOND SURGICAL
WWW.DIAMONDMED.IR INSTRUMENTS



VCZ

Intestinal Stomach



CE

SQS Certificate
ISO 9001:2000
ISO 13485:2003

585



Intestinal & Stomach
Tissue and Organ Holding Forceps
Gewebe- und Organ-Faßzangen
Pinzas para tejidos Y organos

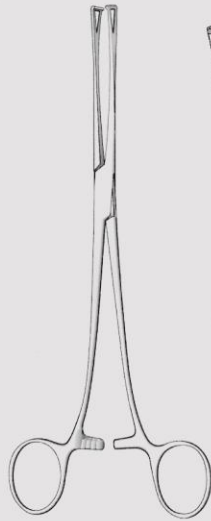
روده و معده
پنس ها



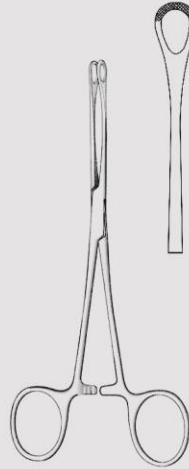
CE

SQS Certificate
ISO 9001:2000
ISO 13485:2003

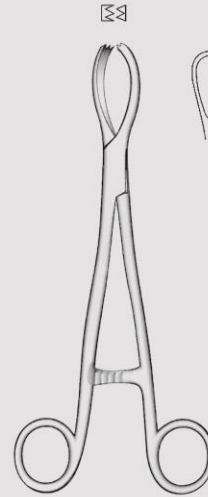
586



Lockwood
VCZ300120
20 cm / 8"



Williams
VCZ300516
16 cm / 6 1/4"



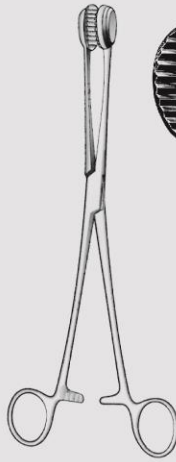
Littlewood
VCZ301019
19 cm / 7 1/2"



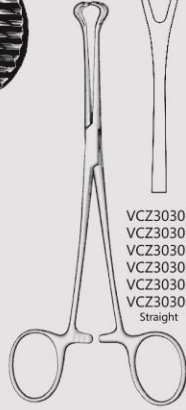
Denis-Browne
VCZ301518
18 cm / 7"



Young
VCZ302021
21 cm / 8 1/4"



Child
VCZ302524
24 cm / 9 1/2"



Babcock
Straight



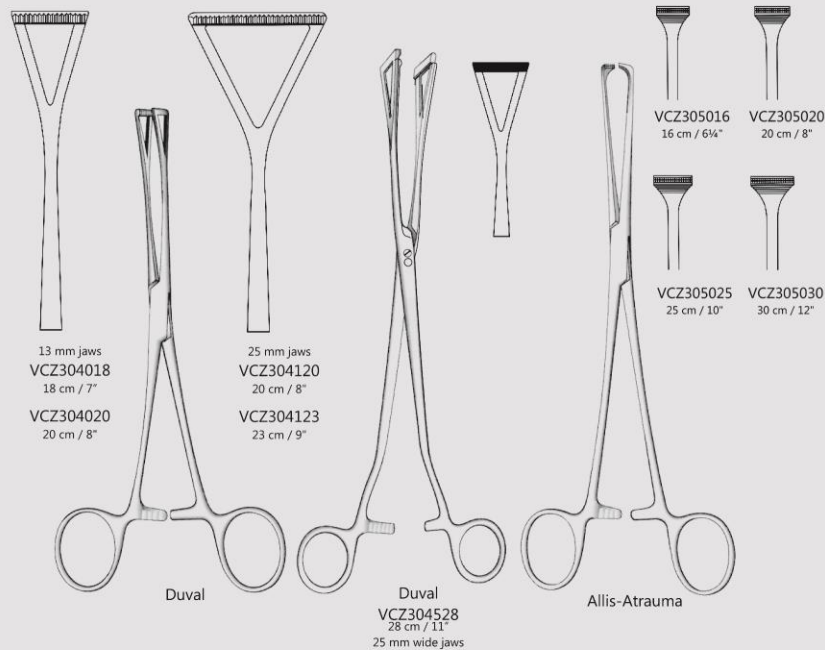
VCZ303014 14 cm / 5 1/2"
VCZ303016 16 cm / 6 1/4"
VCZ303018 18 cm / 7"
VCZ303020 20 cm / 8"
VCZ303024 24 cm / 9 1/2"
VCZ303030 30 cm / 12"
Straight



VCZ303514
VCZ303516
VCZ303518
VCZ303520
VCZ303524
VCZ303530
Angled 45°



Babcock
Angled 45°



Intestinal & Stomach
Tissue and Organ Holding Forceps
Gewebe- und Organ-Faßzangen
Pinzas para tejidos Y organos

معدده و روده
پنس ها



CE

SQS Certificate
ISO 9001:2000
ISO 13485:2003

587



Intestinal & Stomach
Tissue and Organ Holding Forceps
Gewebe- und Organ-Faßzangen
Pinzas para tejidos Y organos

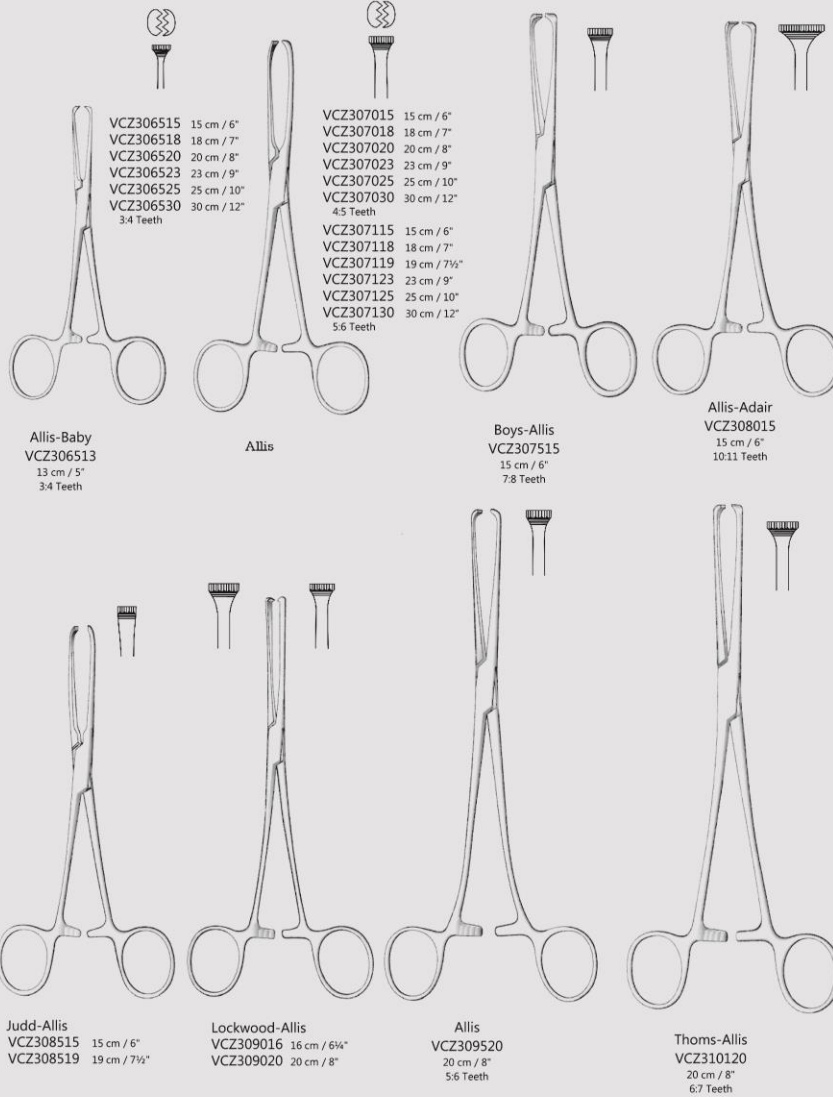
روده و معده
پنس ها



CE

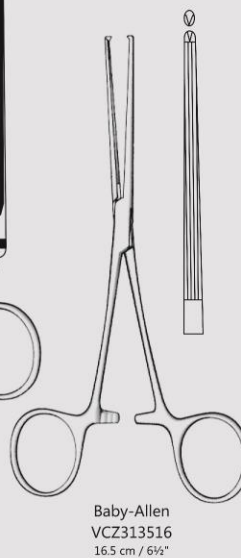
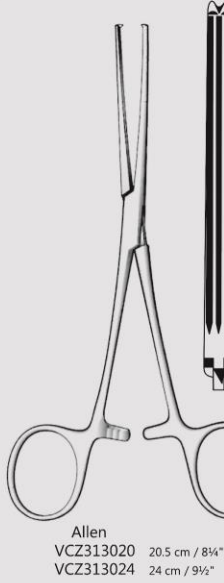
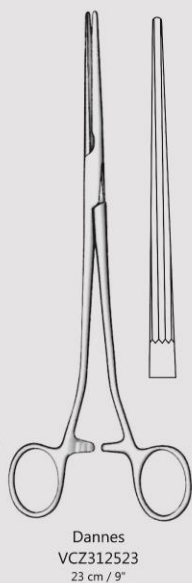
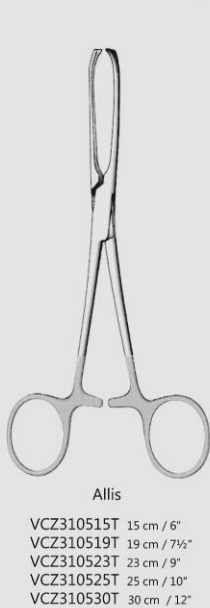
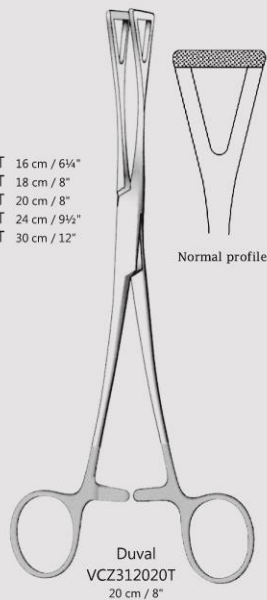
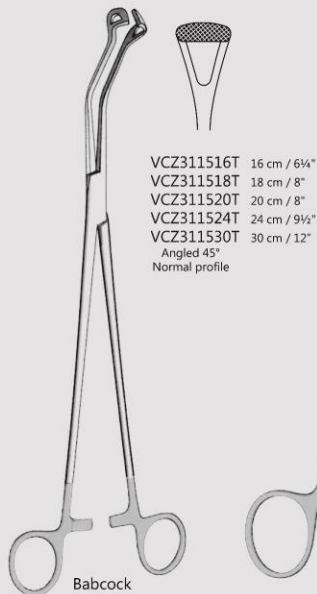
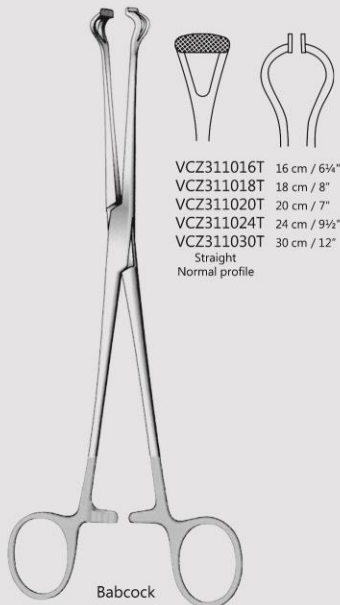
SQS Certificate
ISO 9001:2000
ISO 13485:2003

588



Instruments with Tungsten Carbide Inserts

Tc Gold



Intestinal & Stomach

Tissue and Organ Holding Forceps, Intestinal Clamp Forceps
 Gewebe- und Organ-Faßzangen, Darmklemmen
 Pinzas para tejidos y órganos, Pinzas-clamps intestinales

معدده و روده
 پنس ها



SQS Certificate
 ISO 9001:2000
 ISO 13485:2003





Intestinal & Stomach
 Intestinal Clamp Forceps
 Drankelmmen
 Pinzas-clamps intestinales

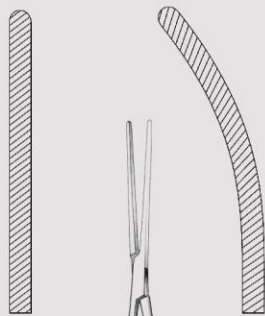
روده و معده
 پنس ها



CE

SQS Certificate
 ISO 9001:2000
 ISO 13485:2003

590

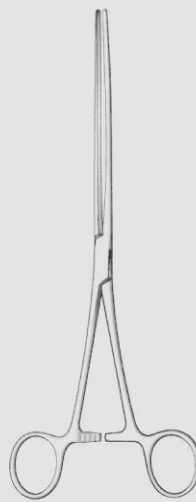


VCZ314017

VCZ314117

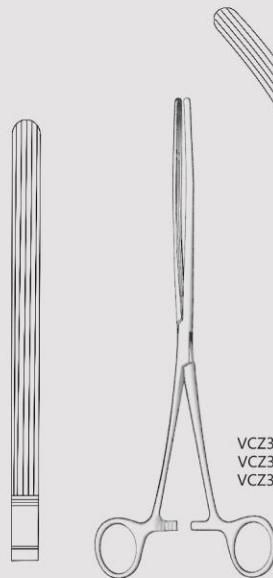


Baby-Doyen
 17 cm / 6 3/4"



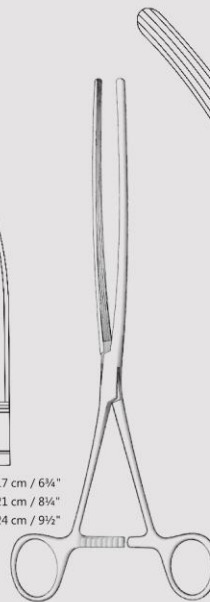
Doyen
 VCZ314521 21 cm / 8 1/4"
 VCZ314523 23 cm / 9"

VCZ314621
 VCZ314623

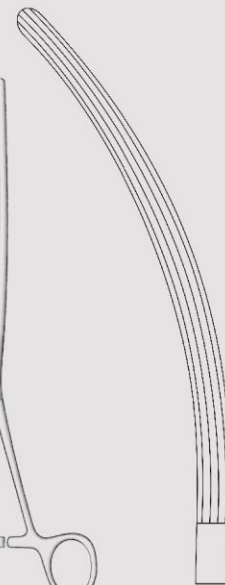


Mayo-Robson

VCZ315117 17 cm / 6 3/4"
 VCZ315121 21 cm / 8 1/4"
 VCZ315124 24 cm / 9 1/2"



Mayo Robson
 25 cm / 10"



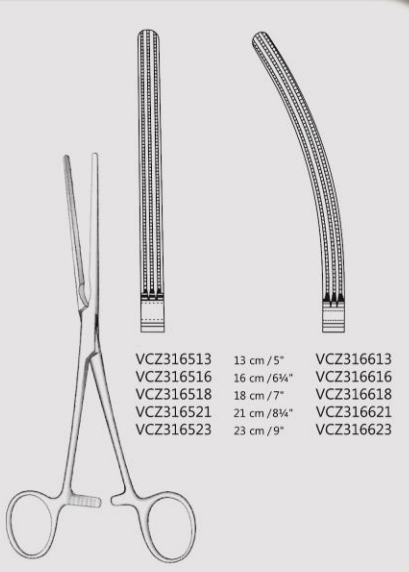
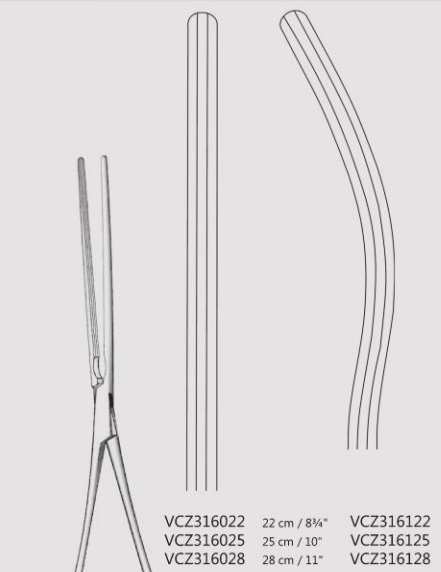
VCZ315625

VCZ315525

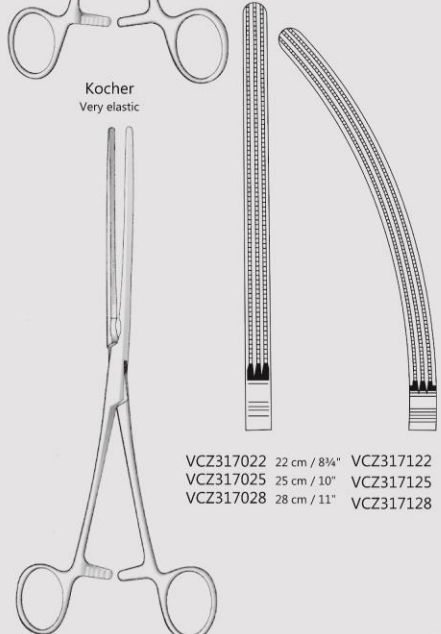
VCZ315017 17 cm / 6 3/4"
 VCZ315021 21 cm / 8 1/4"
 VCZ315024 24 cm / 9 1/2"



Intestinal & Stomach
 Atrauma Intestinal and Stomach
 Clamp Forceps with Serrations
 Atrauma Darm- und Magenklammern mit Zähnung
 Atrauma Pinzas-Clamps intestinales con dentado

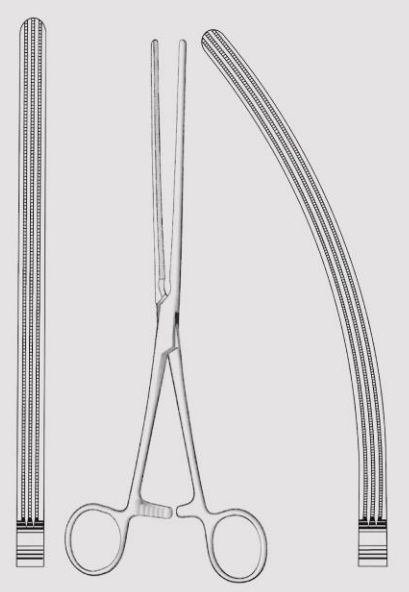


Doyen-Atrauma



Kocher
 Very elastic

Kocher-Atrauma



Mayo-Robson-Atrauma
 25 cm / 10"

معده و روده
 پنس ها



SQS Certificate
 ISO 9001:2000
 ISO 13485:2003





Intestinal & Stomach
Atrauma Sigmoid Anastomosis Forceps
Atrauma Rektum-Anastomoskenkimmen
Atrauma Pinzas para anastomosis del recto

روده و معده
پنس ها



CE

SQS Certificate
ISO 9001:2000
ISO 13485:2003

592



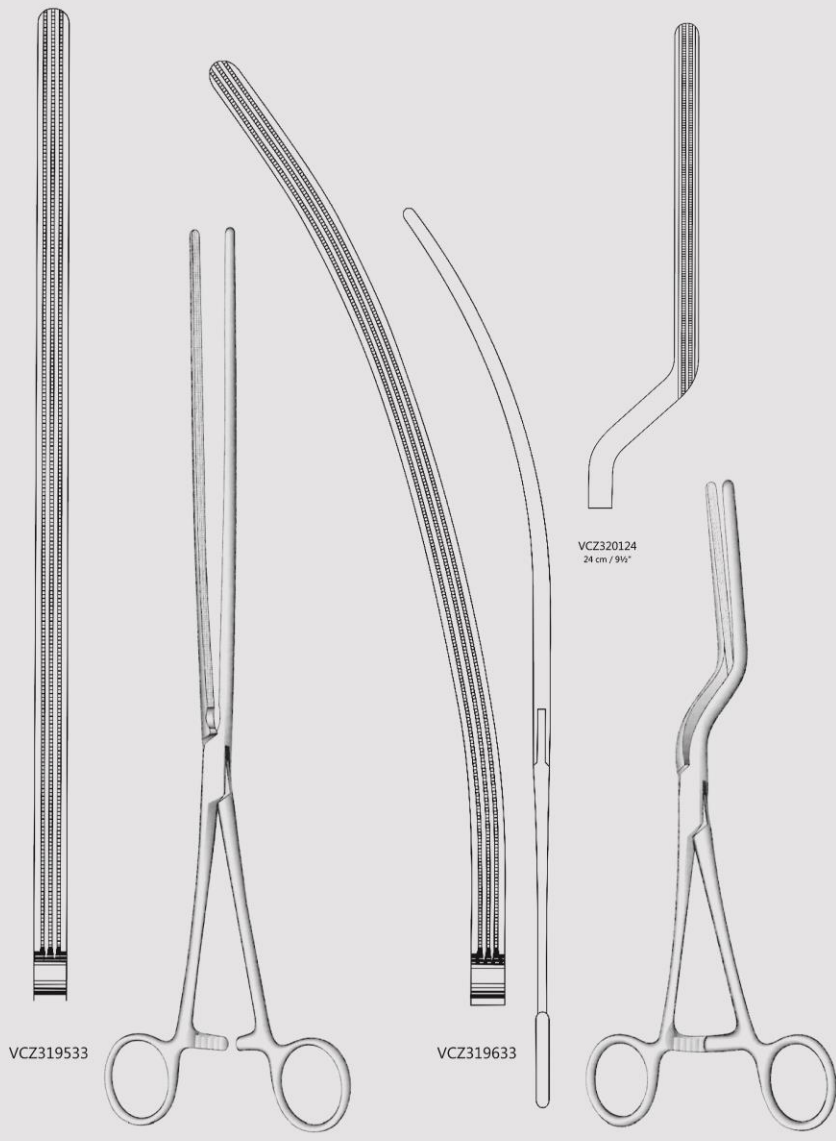
Veidenheimer
VCZ318023
23 cm / 9"

Fehland
VCZ318524
24 cm / 9 1/4"

Resano
VCZ319030
30 cm / 12"



Intestinal & Stomach
 Atrauma Intestinal Clamps,
 Sigmoid Anastomosis Forceps
 Atrauma Darmklammern,
 Rektum-Anastomosenklammern
 Atrauma Pinzas intestinales,
 Pinzas para anastomosis rectales



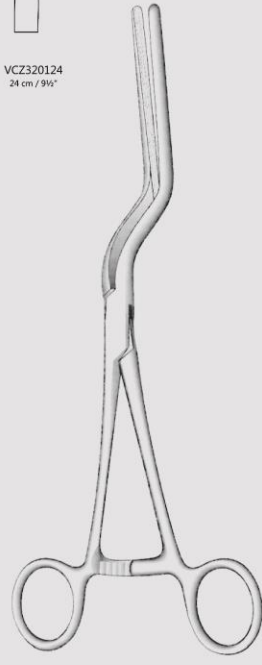
VCZ319533



Scudder-Atrauma
22 cm / 13"

VCZ319633

VCZ320124
24 cm / 9 1/2"



Brunner

معدده و روده
پنس ها



CE

SQS Certificate
 ISO 9001:2000
 ISO 13485:2003





Intestinal & Stomach
Stomach Clamp Forceps
Magnklemmen
Pinzas-clamps estomacales

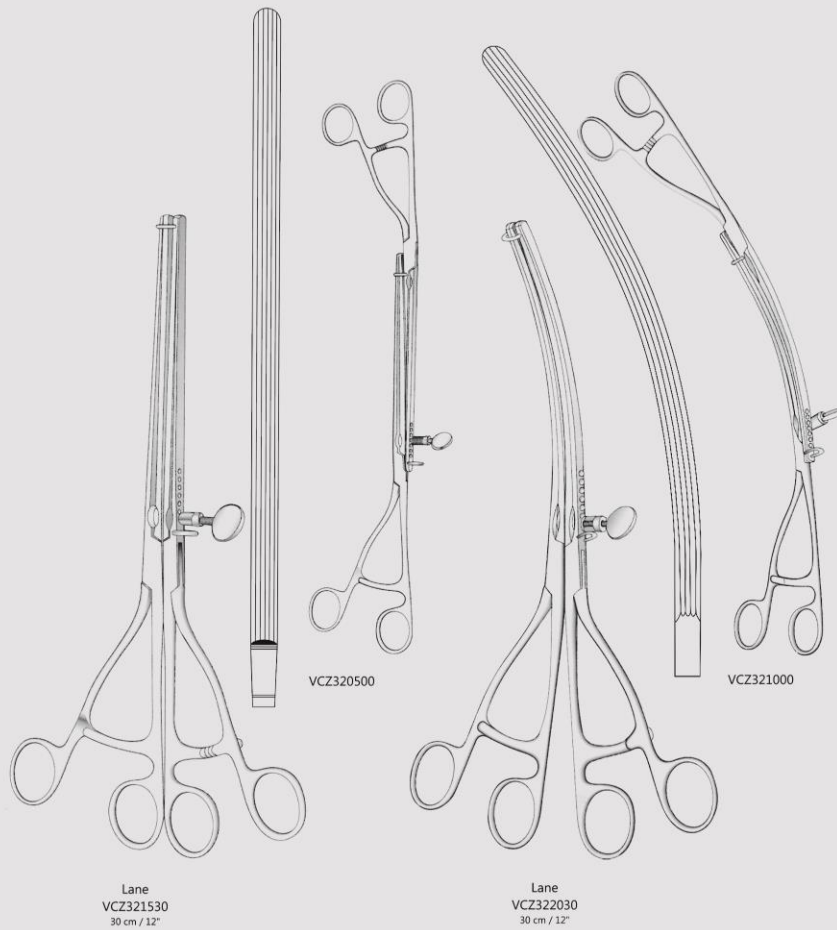
روده و معده
پنس ها کلمپ



CE

SQS Certificate
ISO 9001:2000
ISO 13485:2003

594

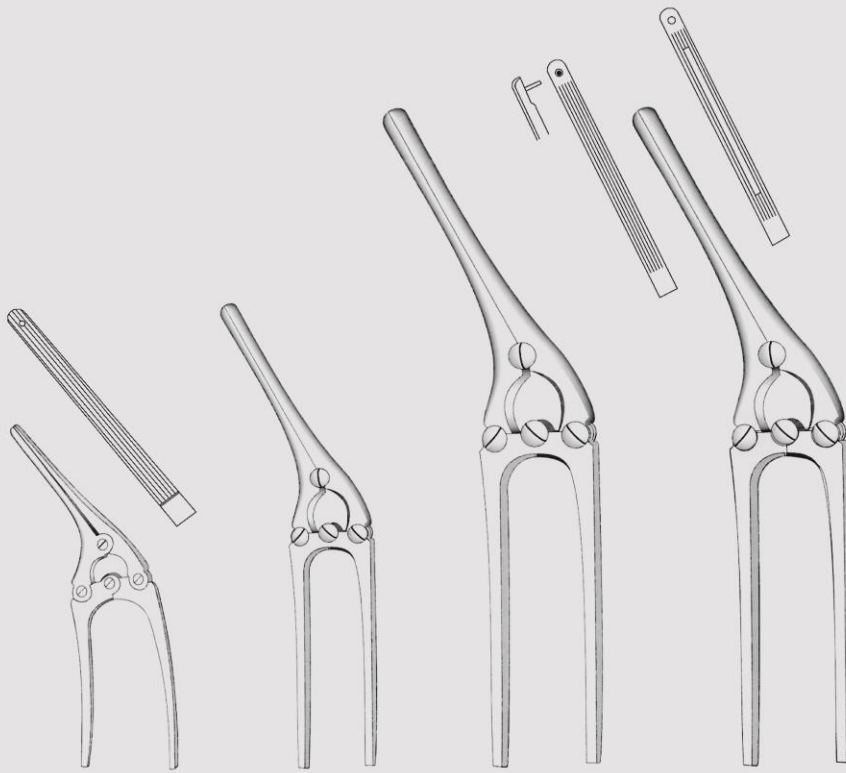




Intestinal & Stomach

Intestinal and Pylorus Clamps
Darmquetschklappen
Pinzas intestinales para piloro

روده و معده
پنس ها کلمپ



Payr-Baby
VCZ322515
15 cm / 6"
With pin

Payr
VCZ323021 With pin
VCZ323121 Without pin
21 cm / 8 1/4"

Payr
VCZ323529 With pin
VCZ323629 Without pin
29 cm / 11 1/2"

Payr
VCZ324035 With pin
VCZ324135 Without pin
VCZ324235 With groove
35 cm / 14"



CE

SQS Certificate
ISO 9001:2000
ISO 13485:2003

595



Intestinal & Stomach

Intestinal and Anastomosis Clamp Forceps
Darmklemmen, Anastomosenklemmen
Pinzas-clamps intestinales Y para anastomosis

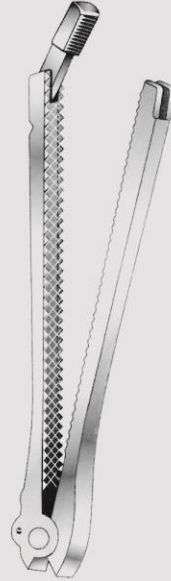
روده و معده
پنس ها



CE

SQS Certificate
ISO 9001:2000
ISO 13485:2003

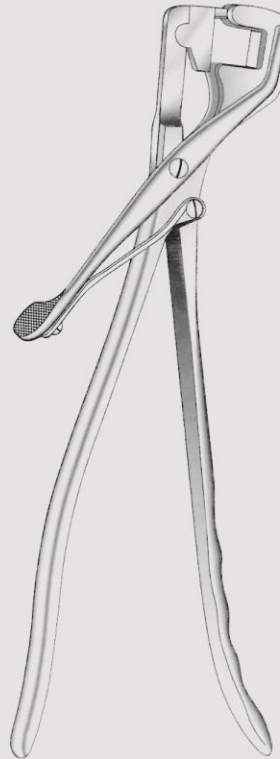
596



DeMartel-Wolfson
Anastomosis Clamps
Sets consist of
2 clamps with short grip
1 clamp with long grip



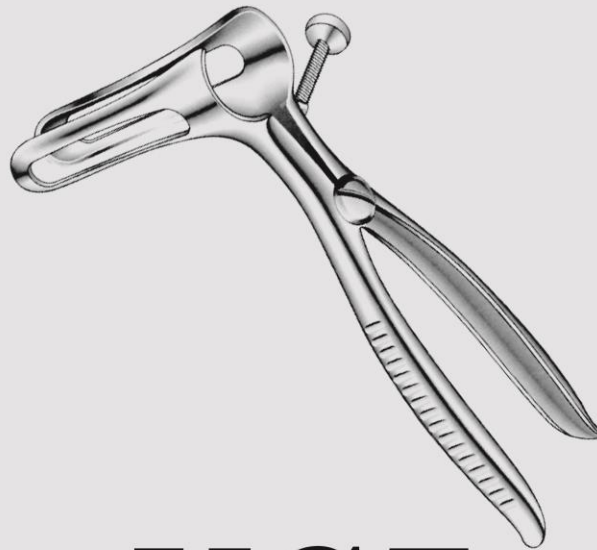
VCZ324500
VCZ324600



VCZ327500

- VCZ325005 Set of 5 cm / 2" long clamps
- VCZ325105 5 cm / 2" clamp with short grip
- VCZ325205 5 cm / 2" clamp with long grip
- VCZ325507 Set of 7.5 cm / 3" long clamps
- VCZ325607 7.5 cm / 3" clamp with short grip
- VCZ325707 7.5 cm / 3" clamp with long grip
- VCZ326010 Set of 10 cm / 4" long clamps
- VCZ326110 10 cm / 4" clamp with short grip
- VCZ326210 10 cm / 4" clamp with long grip
- VCZ326508 Clampholder 8 cm / 3 1/4" long
- VCZ326609 Clampholder 23 cm / 9" long
- VCZ327000 Closing forceps

DIAMOND SURGICAL
WWW.DIAMONDMED.IR INSTRUMENTS



VCZ
Rectum



CE

SQS Certificate
ISO 9001:2000
ISO 13485:2003

597

www.Diamondmed.ir



Rectum
Rectal Specula
Mastdarm-Spekula
Especulos rectales

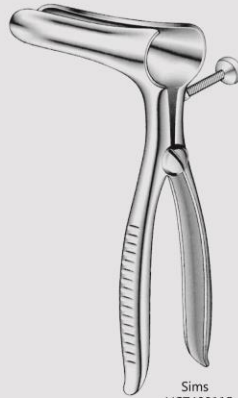
رکتوم
اسپیکلوم
مقعد



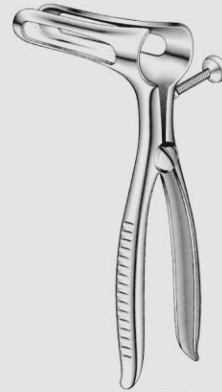
CE

SQS Certificate
ISO 9001:2000
ISO 13485:2003

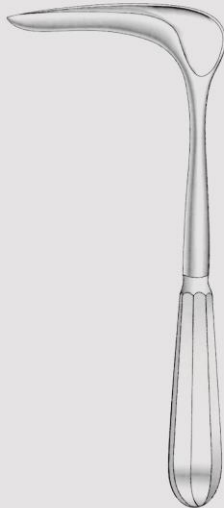
598



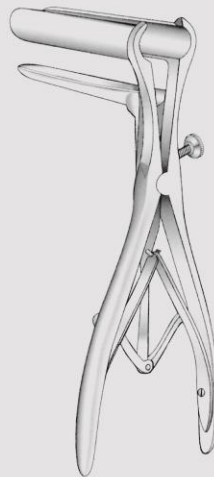
Sims
VCZ400115 Chrome plated
VCZ400215 Stainless steel
15 cm / 6"



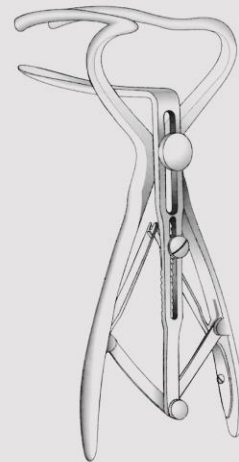
Sims
VCZ400515 Chrome plated
VCZ400615 Stainless steel
15 cm / 6"



Czerny
VCZ401022 Chrome plated
VCZ401122 Stainless steel
22 cm / 8 3/4"



Mathieu
VCZ401519 Chrome plated
VCZ401619 Stainless steel
19.5 cm / 7 3/4"
Working length 90 mm



Cook
VCZ402020 Chrome plated
VCZ402120 Stainless steel
20 cm / 8"
4" deep 1/2" wide

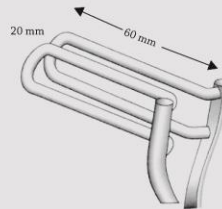
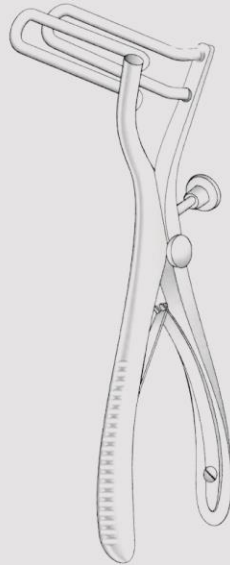


Rectum
Rectal Specula
Mastdarm-Spekula
Especulas rectales

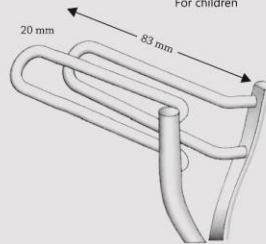
رکتوم
اسپکلوم
اکارتور
مقعد



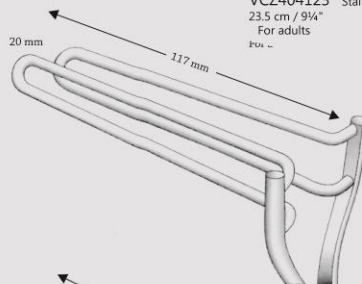
Sawyer
VCZ402500 22 x 37 mm
VCZ402600 35 x 75 mm
VCZ402700 22 x 87 mm
28 cm / 11"



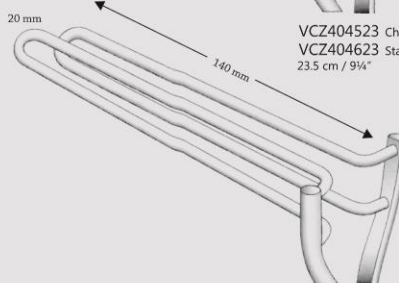
Sims
VCZ403519 Chrome plated
VCZ403619 Stainless steel
19 cm / 7½"
For children



Sims
VCZ404023 Chrome plated
VCZ404123 Stainless steel
23.5 cm / 9¼"
For adults



VCZ404523 Chrome plated
VCZ404623 Stainless steel
23.5 cm / 9¼"



VCZ405024 Chrome plated
VCZ405124 Stainless steel
24.5 cm / 9¼"



Hill-Ferguson
VCZ403021 22 x 65 mm, Small blades
21.5 cm / 8½"
VCZ403022 30 x 75 mm, Large blades
22 cm / 8¾"



SQS Certificate
ISO 9001:2000
ISO 13485:2003

599



Rectum
Rectal Specula
Mastdarm-Spekula
Especulas rectales

رکتوم
اسپیکلوم
مقعد



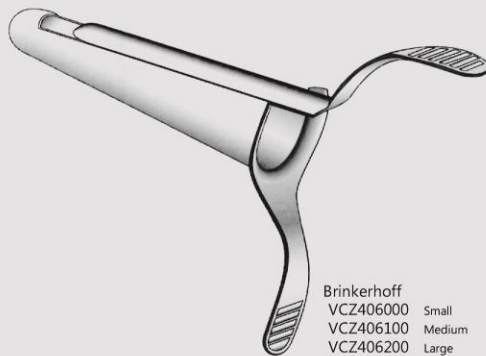
CE

SQS Certificate
ISO 9001:2000
ISO 13485:2003

600



Ricord
VCZ405500
Chrome plated



Brinkerhoff
VCZ406000 Small
VCZ406100 Medium
VCZ406200 Large
Chrome plated

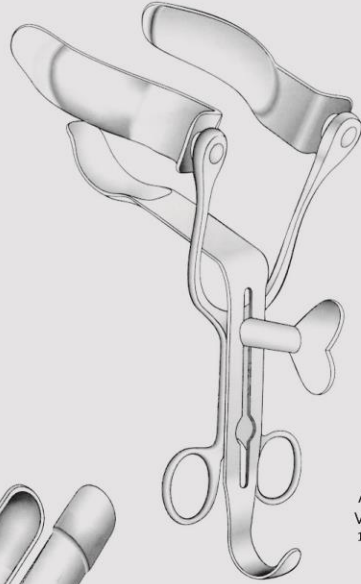


Pratt
VCZ406520
20.5 cm / 8"
Chrome plated



Rectum

Rectal Speculum & Retractors
Analspreizer und Wundhaken
Especulos Rectales Y Separadores



Alan Parks
VCZ407013
13.5 cm / 5 1/2"

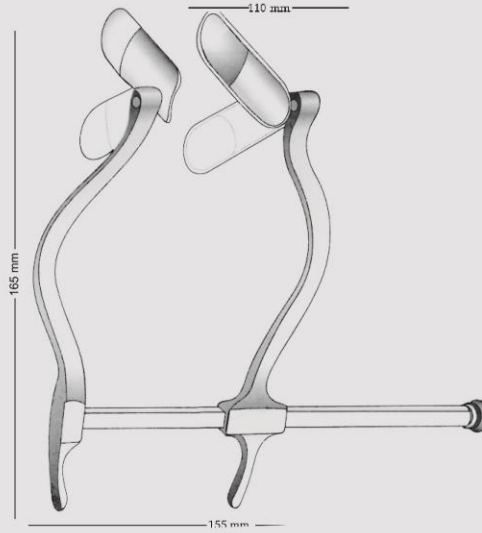


22 mm

22 mm



Barr
VCZ407520
20.5 cm / 8"



Smith-Buie
VCZ408000

رکتوم
اسپکلوم
اکار تورها
مقعد



CE

SQS Certificate
ISO 9001:2000
ISO 13485:2003

601



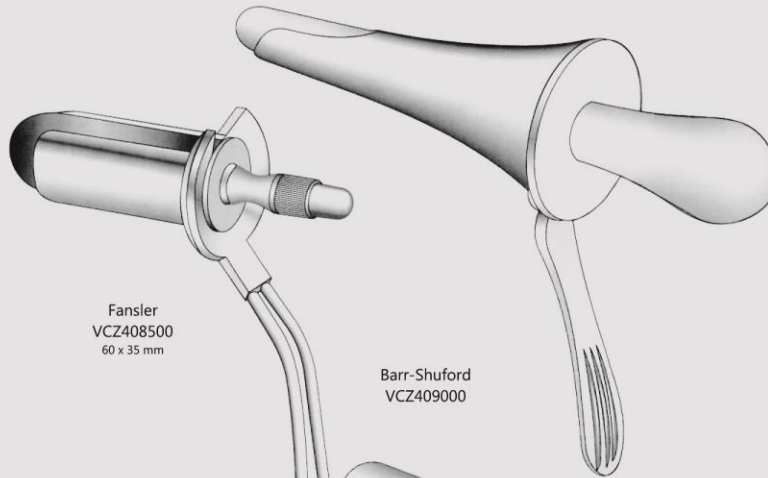
Rectum
Proctoscopes
Proktoskope
Proctoscopios

رکتوم
پروکتوسکوپ ها
مقعد



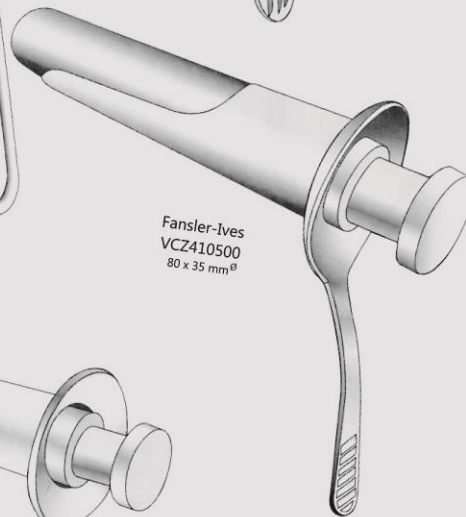
CE
SQS Certificate
ISO 9001:2000
ISO 13485:2003

602



Fansler
VCZ408500
60 x 35 mm

Barr-Shuford
VCZ409000



Fansler-Ives
VCZ410500
80 x 35 mm^Ø



VCZ410100
Obturator for CZ409500

Pennington
VCZ409500
85 x 25 mm^Ø



Rectum
Proctoscopes
Proktoskope
Proctoscopios

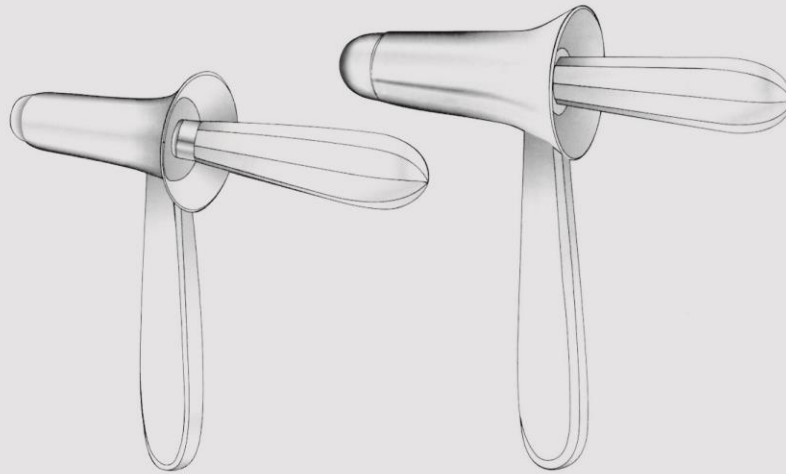
رکتوم
اسپیکلوم
مقعد



CE

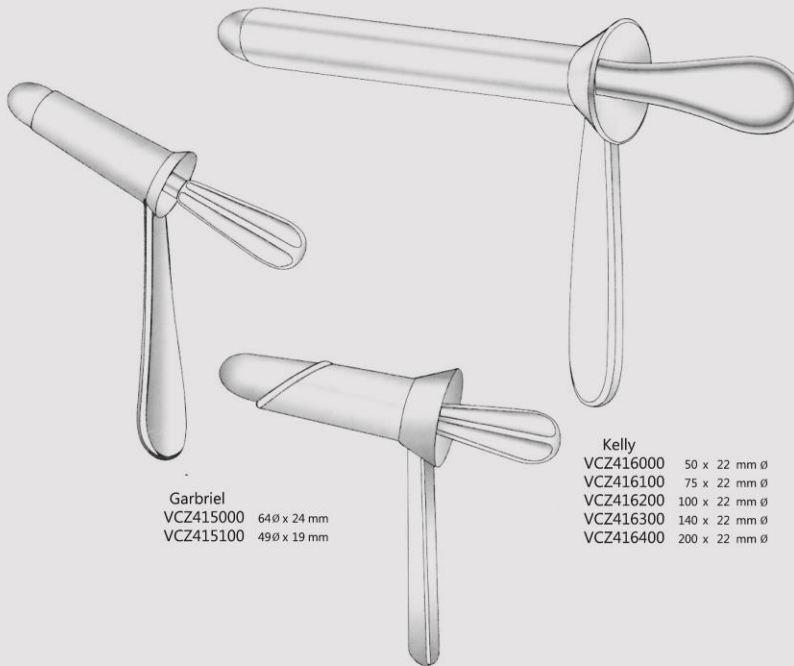
SQS Certificate
ISO 9001:2000
ISO 13485:2003

603



Kelly
VCZ411000 50 x 21 mm \emptyset
VCZ411100 50 x 27 mm \emptyset

Kelly
VCZ414500 64 \emptyset x 25 mm
VCZ414600 36 \emptyset x 22 mm



Gabriel
VCZ415000 64 \emptyset x 24 mm
VCZ415100 49 \emptyset x 19 mm

Kelly
VCZ416000 50 x 22 mm \emptyset
VCZ416100 75 x 22 mm \emptyset
VCZ416200 100 x 22 mm \emptyset
VCZ416300 140 x 22 mm \emptyset
VCZ416400 200 x 22 mm \emptyset

Graeme-Anderson
VCZ415500
64 \emptyset x 24 mm



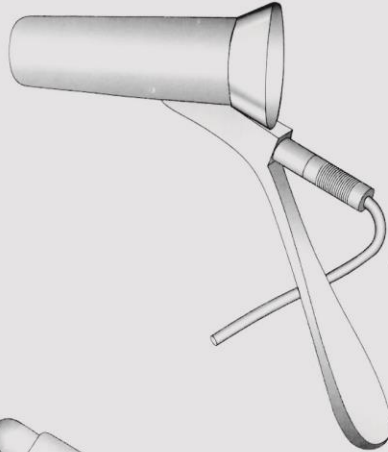
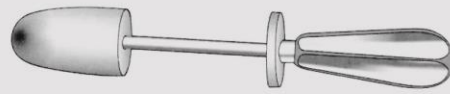
Rectum
 Proctoscopes & Retractors
 Proktoskope und Wundhaken
 Proctoscopios Y Separadores

رکتوم
 پروکتوسکوپ ها
 اکارتورها
 مقعد

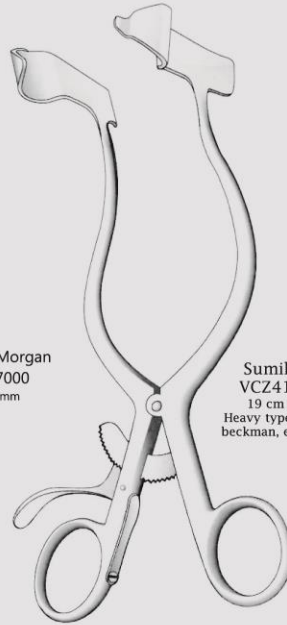


CE
 SQS Certificate
 ISO 9001:2000
 ISO 13485:2003

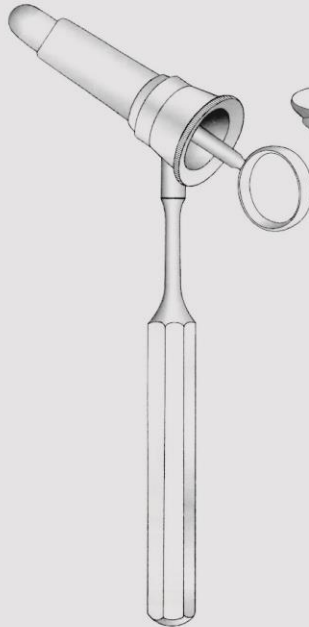
604



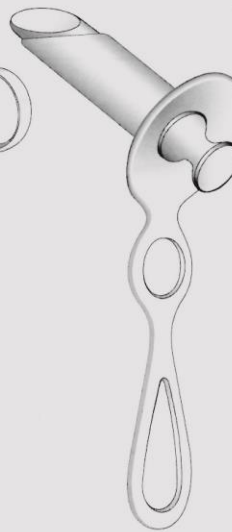
Naunton-Morgan
 VCZ417000
 70 x 22 mm



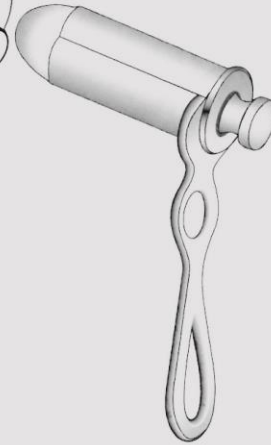
Sumikoshi
 VCZ419019
 19 cm / 7 1/2"
 Heavy type, ratched
 beckman, eaton type



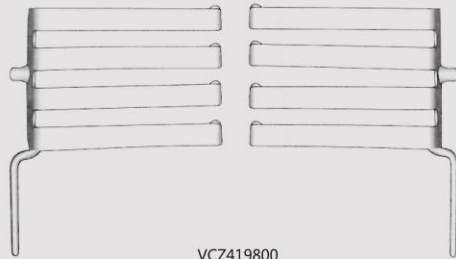
Bensaude
 VCZ418500 70 x 19 mm Ø
 VCZ418600 70 x 22 mm Ø



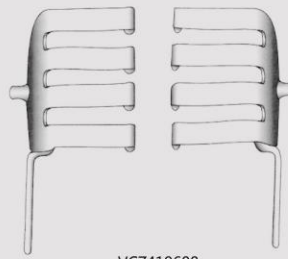
Hirschmann
 VCZ417500 65 x 16 mm Ø
 VCZ417600 65 x 19 mm Ø
 VCZ417700 65 x 22 mm Ø
 Chrome plated



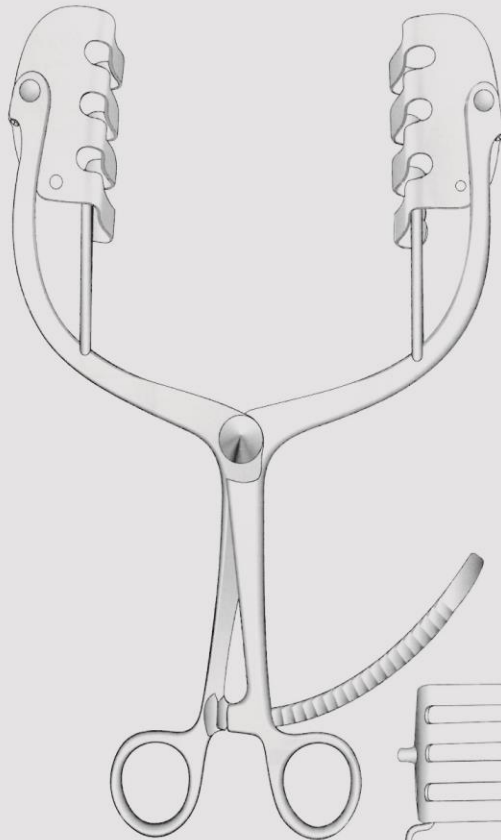
Chelsea Eaton
 VCZ418000 75 x 22 mm Ø
 VCZ418100 75 x 32 mm Ø



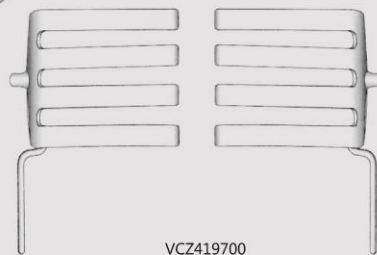
VCZ419800
105 mm x 70 mm



VCZ419600
55 mm x 70 mm



St-Marks
VCZ419500
Complete with 3 pairs of blades
Perineal retractor with towel pegs
fitted to swivel rake blades



VCZ419700
80 mm x 70 mm



Rectum
Retractors
Wundhaken
Separadores

اکار تورها
مقعد



CE

SQS Certificate
ISO 9001:2000
ISO 13485:2003

605



Rectum
Pelvis Retractors
Pelvishaken
Separadores

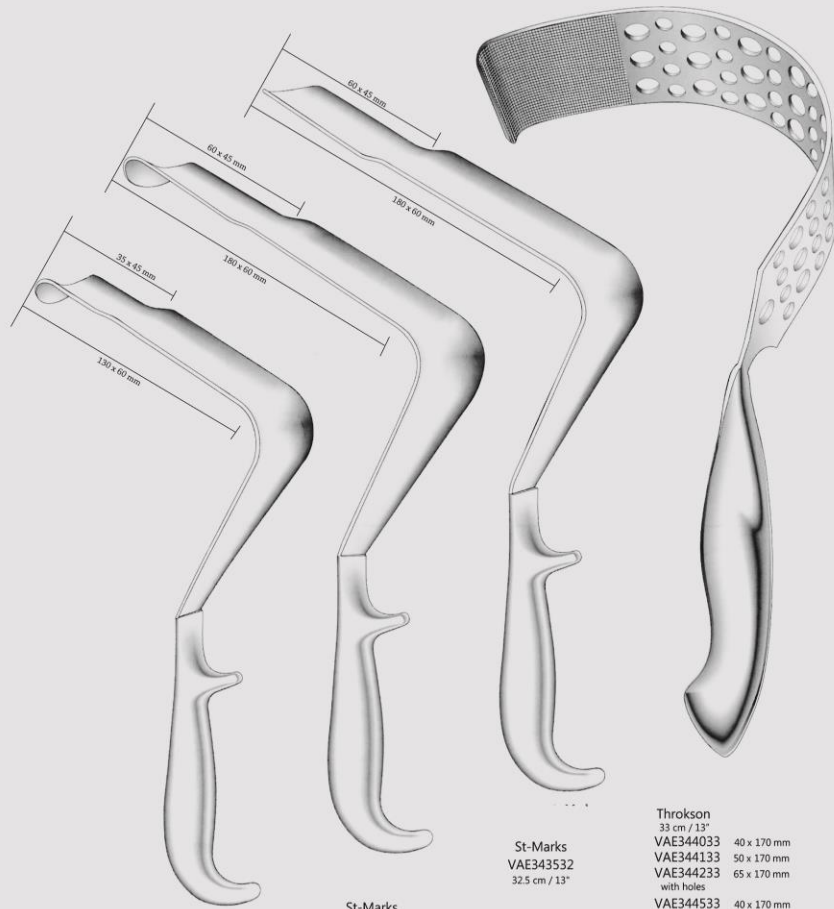
رکتوم
اکارتورها
مقعد



CE

SQS Certificate
ISO 9001:2000
ISO 13485:2003

606



St-Marks
VAE342529
29 cm / 11½"

St-Marks
VAE343032
32.5 cm / 13"

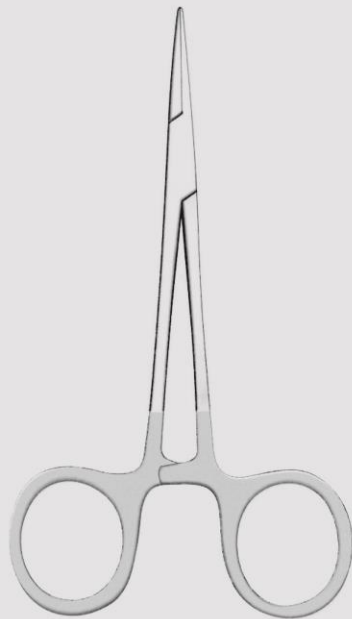
St-Marks
VAE343532
32.5 cm / 13"

Throkson
33 cm / 13"
VAE344033 40 x 170 mm
VAE344133 50 x 170 mm
VAE344233 65 x 170 mm
with holes
VAE344533 40 x 170 mm
VAE344633 50 x 170 mm
VAE344733 65 x 170 mm
with 3 slots

⚠ See picture on page 161



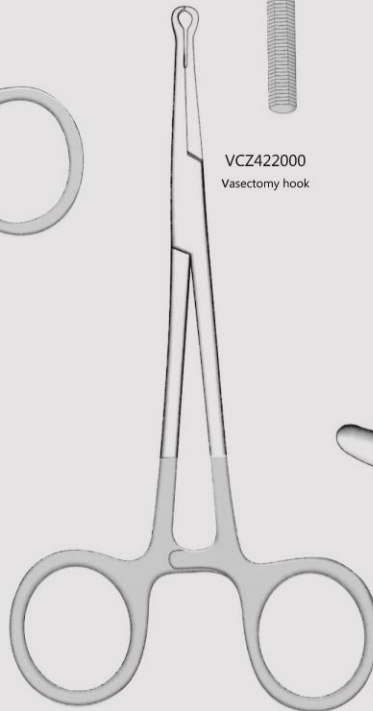
Rectum
Vasectomy Set



VCZ421512 12 cm
VCZ421514 14 cm
Vasectomy forceps



VCZ422000
Vasectomy hook



VCZ422500 3 mm tip
VCZ422600 5 mm tip
Vasectomy towel clamp



Vasectomy
VCZ423018
18 cm / 7"
Tip 3.7 mm

رکتوم



CE

SQS Certificate
ISO 9001:2000
ISO 13485:2003

607

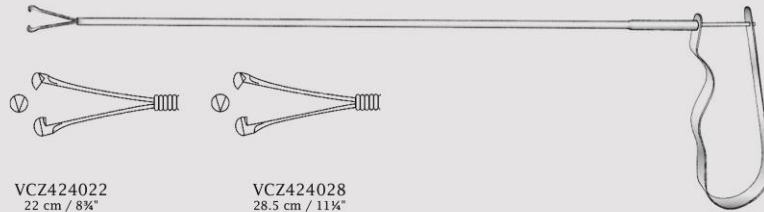


Rectum

Hemorrhoidal Forceps, IUP Grasping Forceps
Hämorrhoidalzangen, IUP Fasszangen
Pinzas-clamps hemorroidales, Pinzas para coger DIU



VAF303537
37.5 cm / 15"
VAF303545
45 cm / 17¾"



VCZ424022
22 cm / 8¾"
3.0 mmØ

VCZ424028
28.5 cm / 11¼"
3.0 mmØ

رکتوم ، پنس
هموروئید

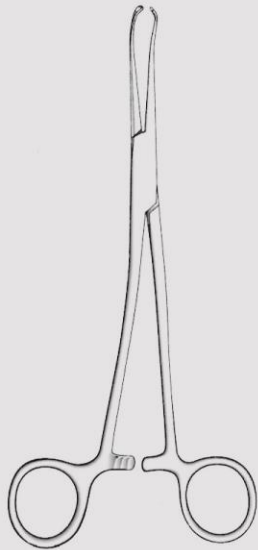


CE

SQS Certificate
ISO 9001:2000
ISO 13485:2003

608

Flexible shaft
For grasping intra uterine pessary



Mc-Givney
VCZ424500
Reverse jaws



Mc-Givney
VCZ425019
19 cm / 7½"



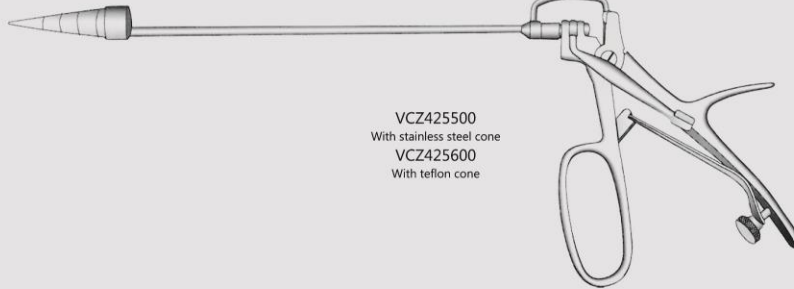
Rectum
Hemorrhoidal Forceps
Hamorrhoidalzangen
Pinzas-clamps hemorroidales



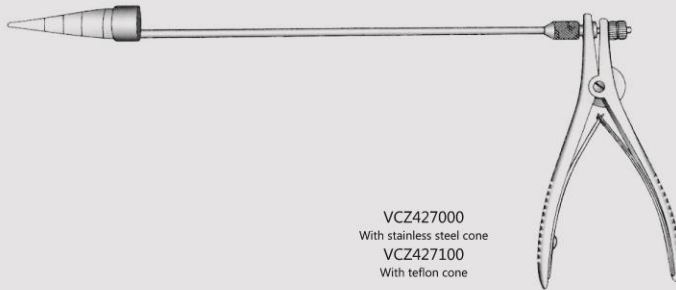
VCZ426000
Stainless steel



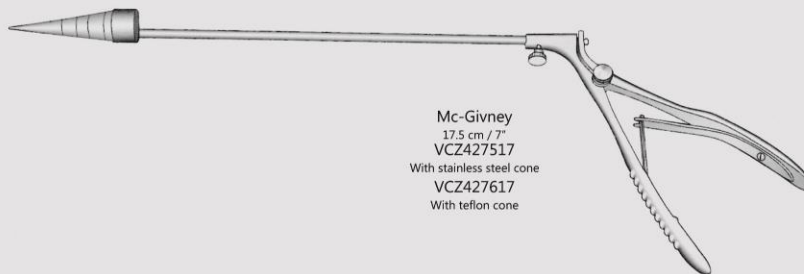
VCZ426500
Teflon cone



VCZ425500
With stainless steel cone
VCZ425600
With teflon cone



VCZ427000
With stainless steel cone
VCZ427100
With teflon cone



Mc-Givney
17.5 cm / 7"
VCZ427517
With stainless steel cone
VCZ427617
With teflon cone



VCZ428000
With stainless steel cone
VCZ428100
With teflon cone

پنس، رکتوم
هموروئید



CE

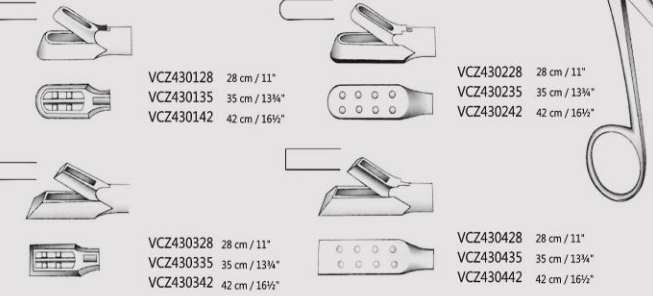
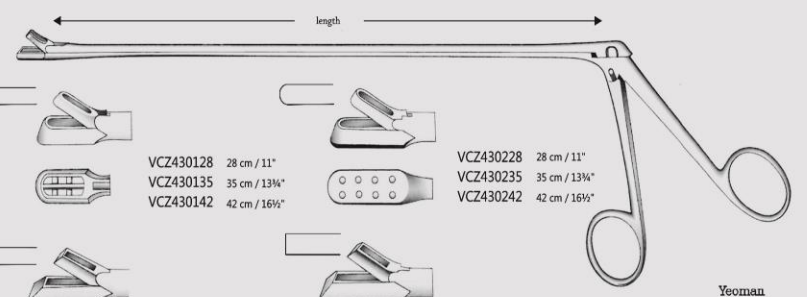
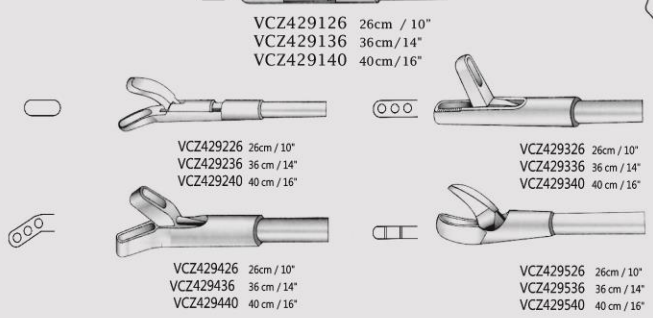
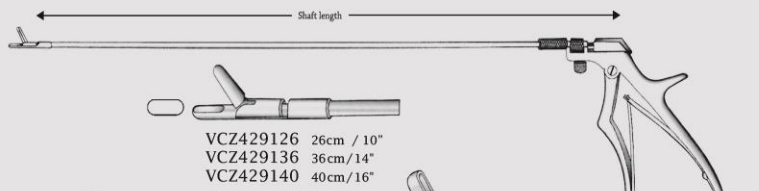
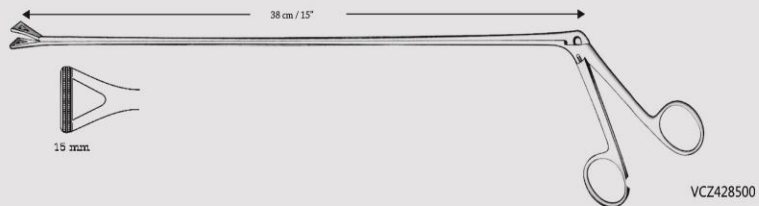
SQS Certificate
ISO 9001:2000
ISO 13485:2003

609



Rectum

Rectal Biopsy Specimen Forceps
Mastdarm-Biopsiezangen
Pinza Sacabocado para biopsia rectal



CE
SQS Certificate
ISO 9001:2000
ISO 13485:2003





Rectum
Rectal Forcep, Grooved Directors
Mastdarmzangen, Hohlsonden
Pinzas clamps rectal, Sondas acanaladas

رکتوم
پنس ها
دیلاتورها



CE

SQS Certificate
ISO 9001:2000
ISO 13485:2003

611



Rectum

Grooved Directors & Hooks
Hohlsonden und Haken
Sondas acanaladas Y Ganchos

رکتوم



CE

SQS Certificate
ISO 9001:2000
ISO 13485:2003

612



Buie
VCZ433517
17 cm / 6 3/4"



Pratt
VCZ434028
28 cm / 11"



Barr
VCZ434518
18 cm / 7"



Blanchard
VCZ435017
17 cm / 6 3/4"



VCZ436022
Narrow



VCZ436122
Short



VCZ436222
Long



Barr
VCZ435525
25 cm / 10"



Pratt
22 cm / 8 3/4"

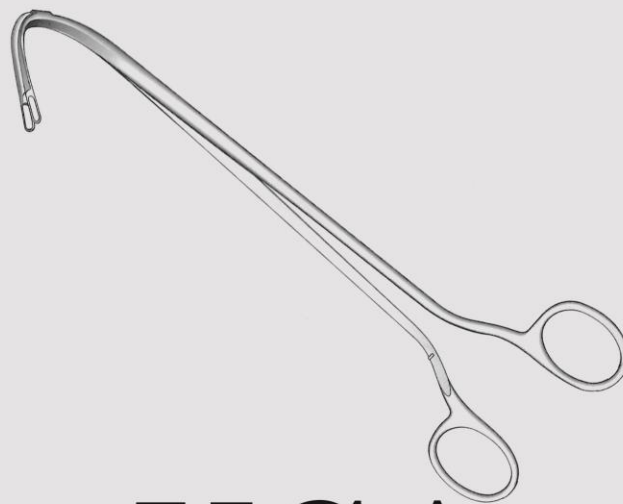


Stewart
VCZ436522 Short
VCZ436622 Long
22 cm / 8 3/4"



Rossor
VCZ437017
17 cm / 6 3/4"

DIAMOND SURGICAL
WWW.DIAMONDMED.IR INSTRUMENTS



VCA
Liver, Gall, Kidney



CE

SQS Certificate
ISO 9001:2000
ISO 13485:2003

613

www.Diamondmed.ir



Liver, Gall, Kidney
Kidney Stone Forceps
Nierensteinzangen
Pinzas para calculos renales

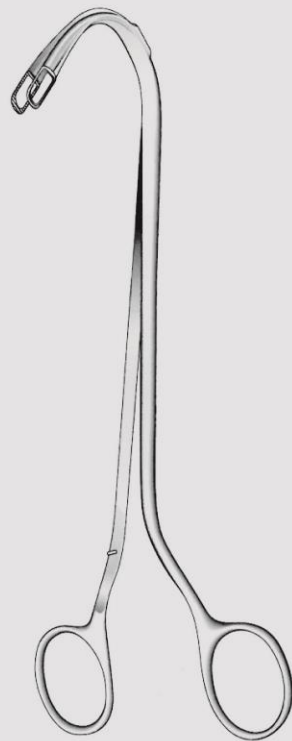
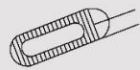
کلیه ، صفرا
پنس ها



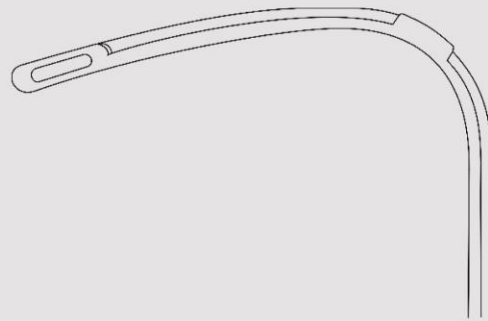
CE

SQS Certificate
ISO 9001:2000
ISO 13485:2003

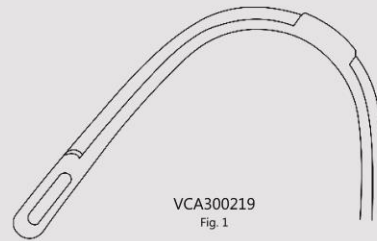
614



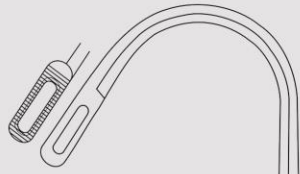
Randall
19 cm / 7½"



VCA300119
Fig. 2



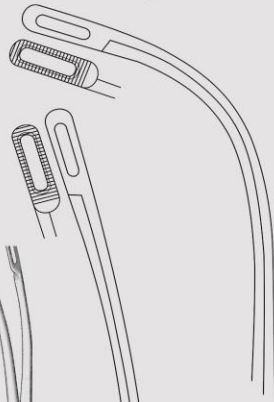
VCA300219
Fig. 1



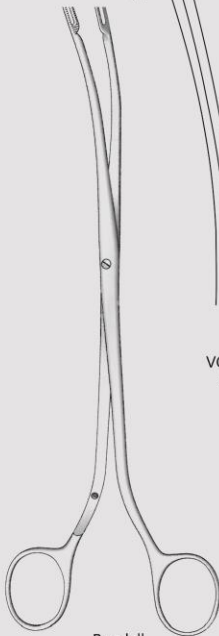
VCA300922
22 cm / 8 3/4"
Fig. 4



VCA300822
22 cm / 8 3/4"
Fig. 3

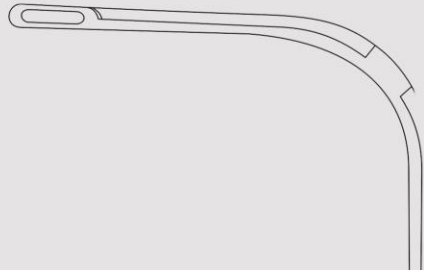


VCA300722
22 cm / 8 3/4"
Fig. 2

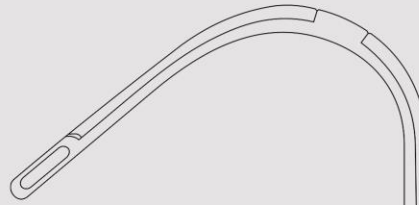


Randall
VCA300523
23 cm / 9"

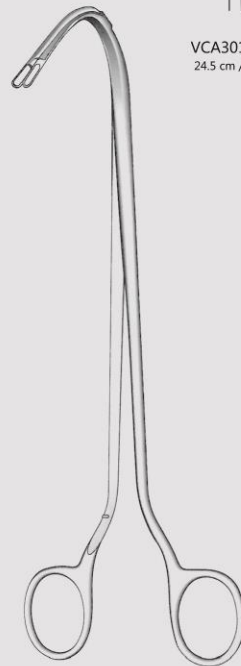
VCA300623
23 cm / 9"
Fig. 1



VCA301523
23 cm / 9"



VCA301524
24.5 cm / 9 3/4"



Randall
Extremely delicate pattern



Gall, Kidney
Stone Forceps
teinzangen
para calculos renales

کلیه ، صفرا
پنس ها



CE

SQS Certificate
ISO 9001:2000
ISO 13485:2003

615



Liver, Gall, Kidney
Nephrostomy Forceps
Nierenfisteizangen
Pinza para nefrostomia

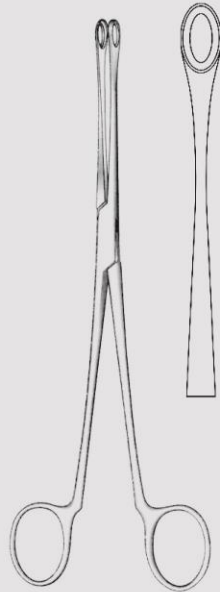
کلیه ، صفرا
پنس ها



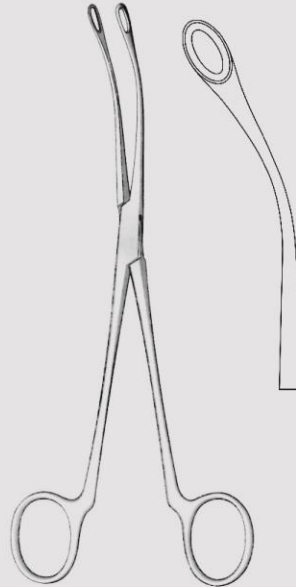
CE

SQS Certificate
ISO 9001:2000
ISO 13485:2003

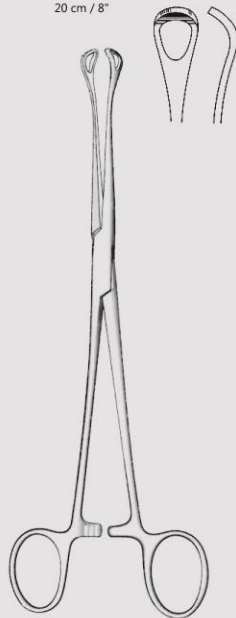
616



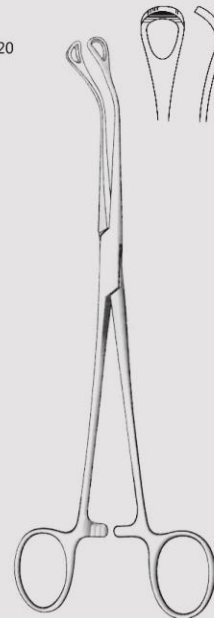
Blake
VCA302520
20 cm / 8"



Blake
VCA303020
20 cm / 8"



Mayo-Blake
VCA303520
20 cm / 8"



Mayo-Blake
VCA304020
20 cm / 8"



Liver, Gall, Kidney
Kidney Stone Forceps
Nierensteinzangen
Pinzas para calculos renales



VCA305023



VCA305523



VCA305623



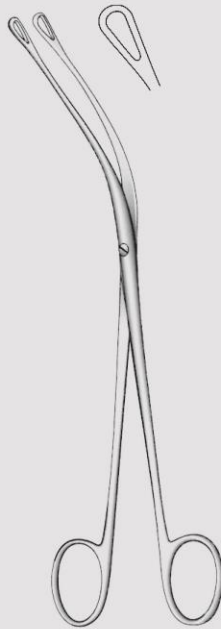
VCA305123



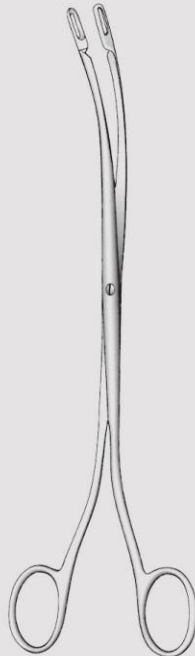
VCA305723



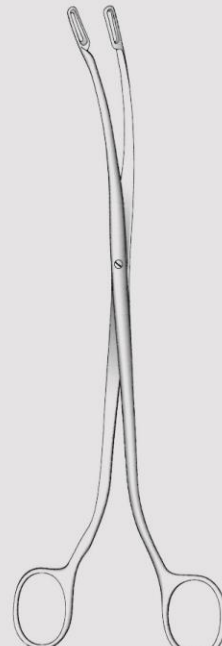
VCA305823



Mixer
VCA304522
22 cm / 8 1/2"



Desjardins
23 cm / 9"



Desjardins
23 cm / 9"

کلیه ، صفرا
پنس ها



CE

SQS Certificate
ISO 9001:2000
ISO 13485:2003

617



Liver, Gall, Kidney
Nephrostomy Forceps
Nierenfisteizangen
Pinza para nefrostomia

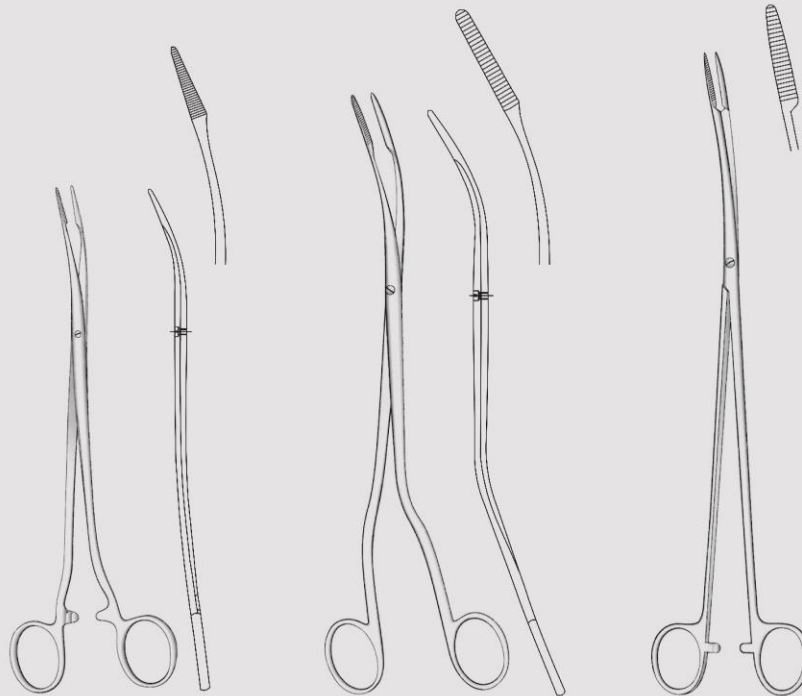
کلیه ، صفرا
پنس ها



CE

SQS Certificate
ISO 9001:2000
ISO 13485:2003

618



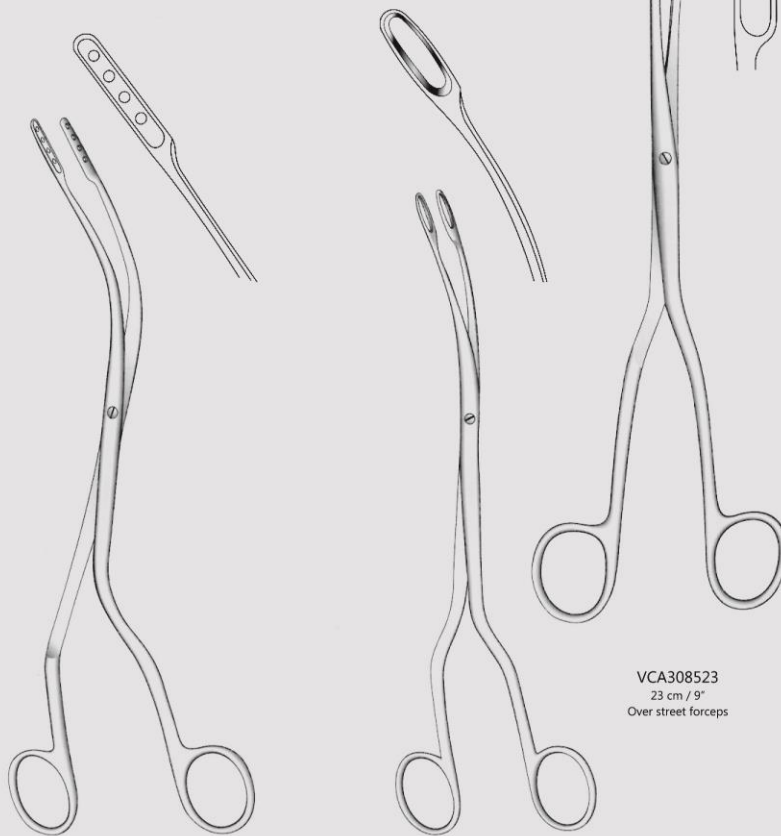
VCA306021
21 cm / 8 1/4"

Czerny
VCA306524
24.5 cm / 9 1/4"

Pelkmann
VCA307026
26 cm / 10 1/4"



Liver, Gall, Kidney
Kidney Stone Forceps
Nierensteinzangen
Pinzas para calculos renales



Tubinger-Modell
VCA307525
25 cm / 10"

Stille
VCA308024
24,5 cm / 9 1/4"

VCA308523
23 cm / 9"
Over street forceps

کلیه ، صفرا
پنس ها



CE

SQS Certificate
ISO 9001:2000
ISO 13485:2003

619



Liver, Gall, Kidney
Nephrostomy Forceps
Nierenfisteizangen
Pinza para nefrostomia

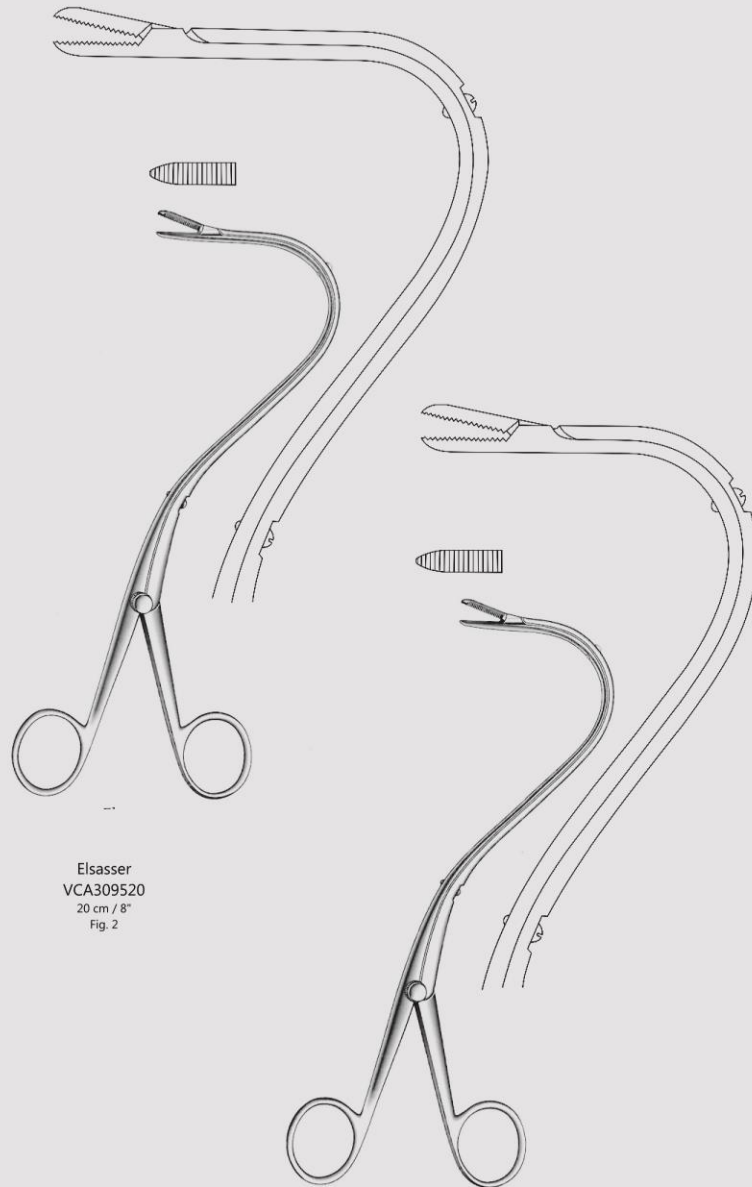
کلیه ، صفرا
پنس ها



CE

SQS Certificate
ISO 9001:2000
ISO 13485:2003

620

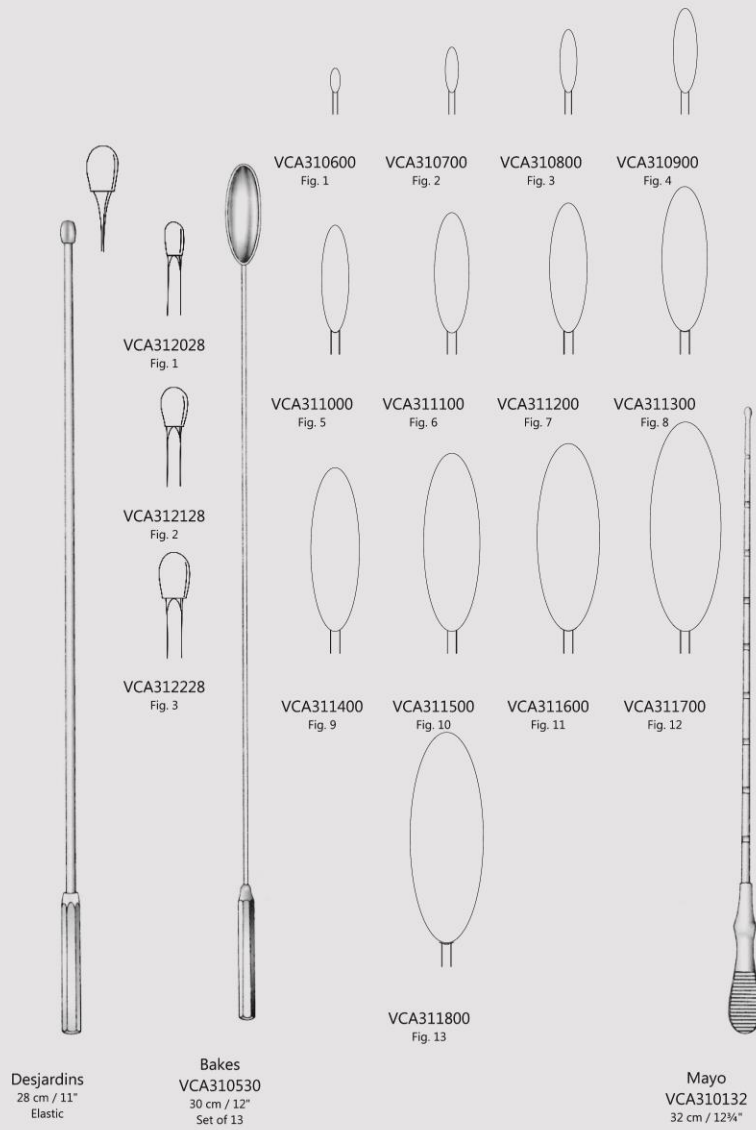


Elsasser
VCA309520
20 cm / 8"
Fig. 2

Elsasser
VCA309020
20 cm / 8"
Fig. 1



Liver, Gall, Kidney
Gall Duct Dilators
Gallenkanal Dilatatore
Dilatadores para conductos biliar



کلیه، صفرا
دیلاتور



CE

SQS Certificate
ISO 9001:2000
ISO 13485:2003

621



Liver, Gall, Kidney
 Gall Stone Probes, Gall Stone Scoops
 Gallensteinsonden, Gallensteinhaken
 Espatulas para calculos biliares, Cuchillas para recoger calculos biliares

کلیه ، صفرا



CE

SQS Certificate
 ISO 9001:2000
 ISO 13485:2003

622



VCA312528



VCA312628



VCA312728



VCA313030
Small



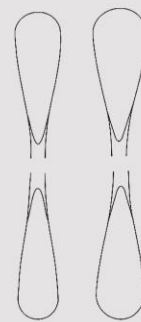
VCA313130
Medium



VCA313230
Large



VCA313330
Extra Large

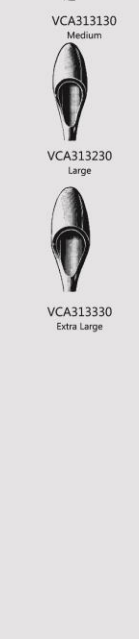


VCA314521
21.5 cm / 8½"
Small

VCA314522
22 cm / 8¾"
Medium



Desjardins
28 cm / 12"
Elastic



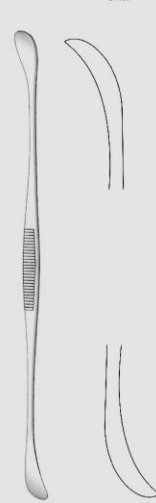
Desjardins
30 cm / 11"
Elastic



Moynihan
VCA313513
34 cm / 13½"



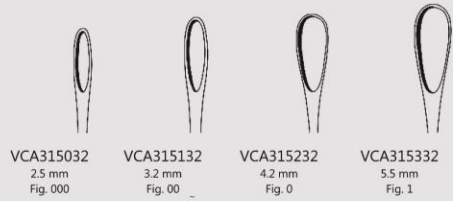
Mayo
VCA314028
28 cm / 11"



Fergusson



VCA314523
23.5 cm / 9¼"
Large

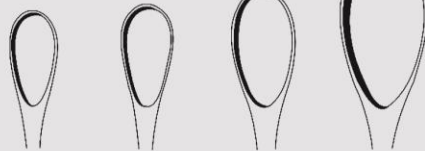


VCA315032
2.5 mm
Fig. 000

VCA315132
3.2 mm
Fig. 00

VCA315232
4.2 mm
Fig. 0

VCA315332
5.5 mm
Fig. 1

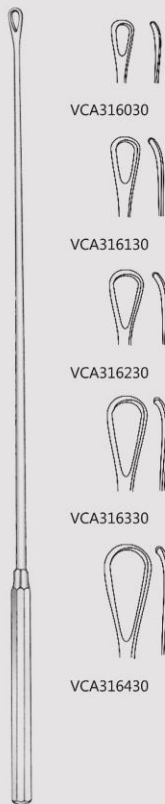


VCA315432
6.7 mm
Fig. 2

VCA315532
8.0 mm
Fig. 3

VCA315632
11 mm
Fig. 4

VCA315732
15 mm
Fig. 5



Muenchen Model
30 cm / 12"



Luer-Koerte
32 cm / 12 3/4"



Liver, Gall, Kidney
Gall Stone Scoops
Gallensteinloffel
Cucharillas para coger calculos biliares

کلیه، صفرا



CE

SQS Certificate
ISO 9001:2000
ISO 13485:2003

623



Liver, Gall, Kidney
Prostatic Retractors
Prostatahaken
Separadores para la prostata

کلیه ، صفرا
اکارتورها



CE

SQS Certificate
ISO 9001:2000
ISO 13485:2003

624



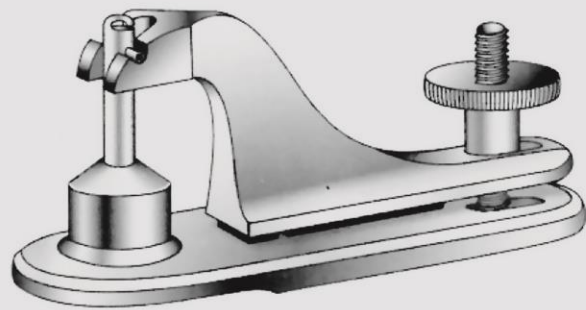
Young
VCA317021
21.5 cm / 8½"

Young
VCA317521
21 cm / 8½"

Young
VCA318022
22 cm / 8¾"

Young
VCA318521
21 cm / 8½"

DIAMOND SURGICAL
WWW.DIAMONDMED.IR INSTRUMENTS



VCA
Urology



CE

SQS Certificate
ISO 9001:2000
ISO 13485:2003

625

www.Diamondmed.ir



Urology
Capsule Forceps
Kapsselfasszangen
Pinzas capsulares

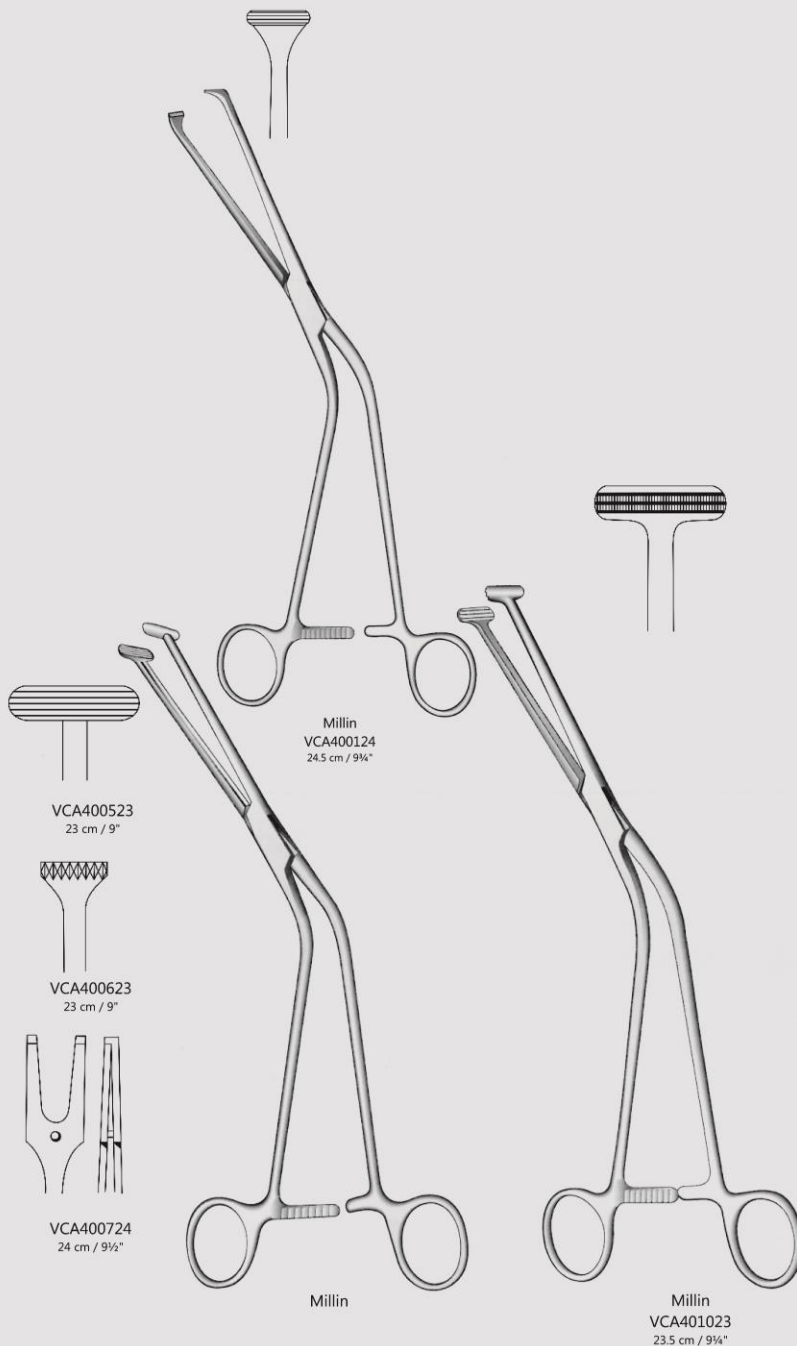
ارولوژی
پنس ها



CE

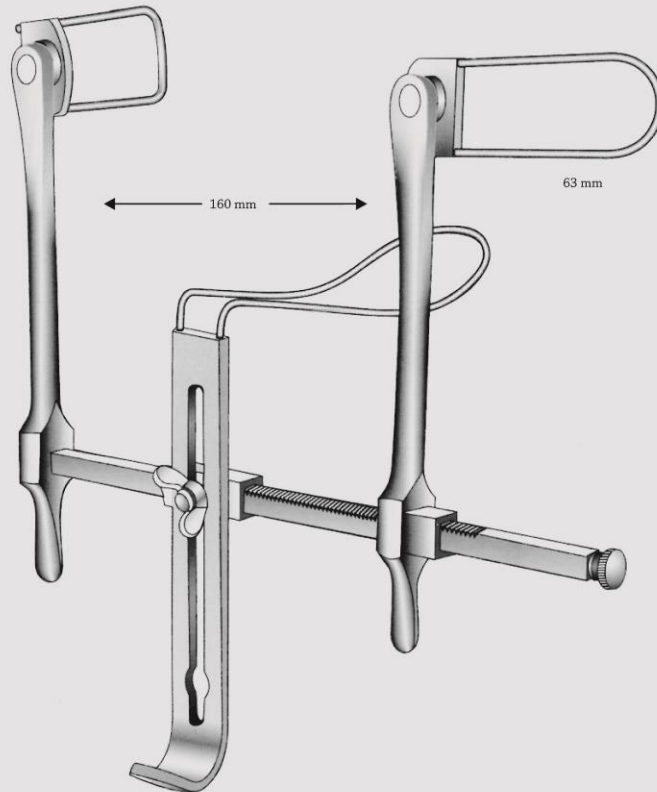
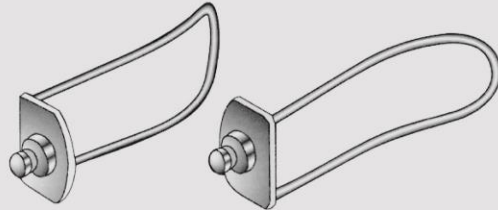
SQS Certificate
ISO 9001:2000
ISO 13485:2003

626





Urology
Bladder Retractors
Blasen-Wundseizer
Separadores vesivales



Gosset
VCA401500

ارولوژی، اکارتور



CE

SQS Certificate
ISO 9001:2000
ISO 13485:2003

627

www.Diamondmed.ir



Urology
Bladder Neck Spreaders
Blasenhalsperrer
Dilatador para el cuello vesical

ارولوژی



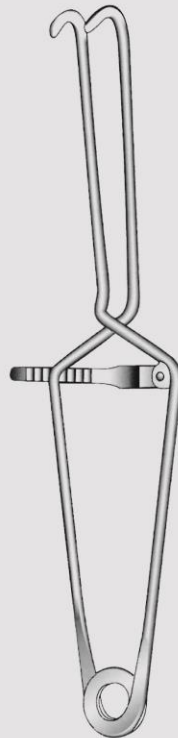
CE

SQS Certificate
ISO 9001:2000
ISO 13485:2003

628



Millin
VCA402000



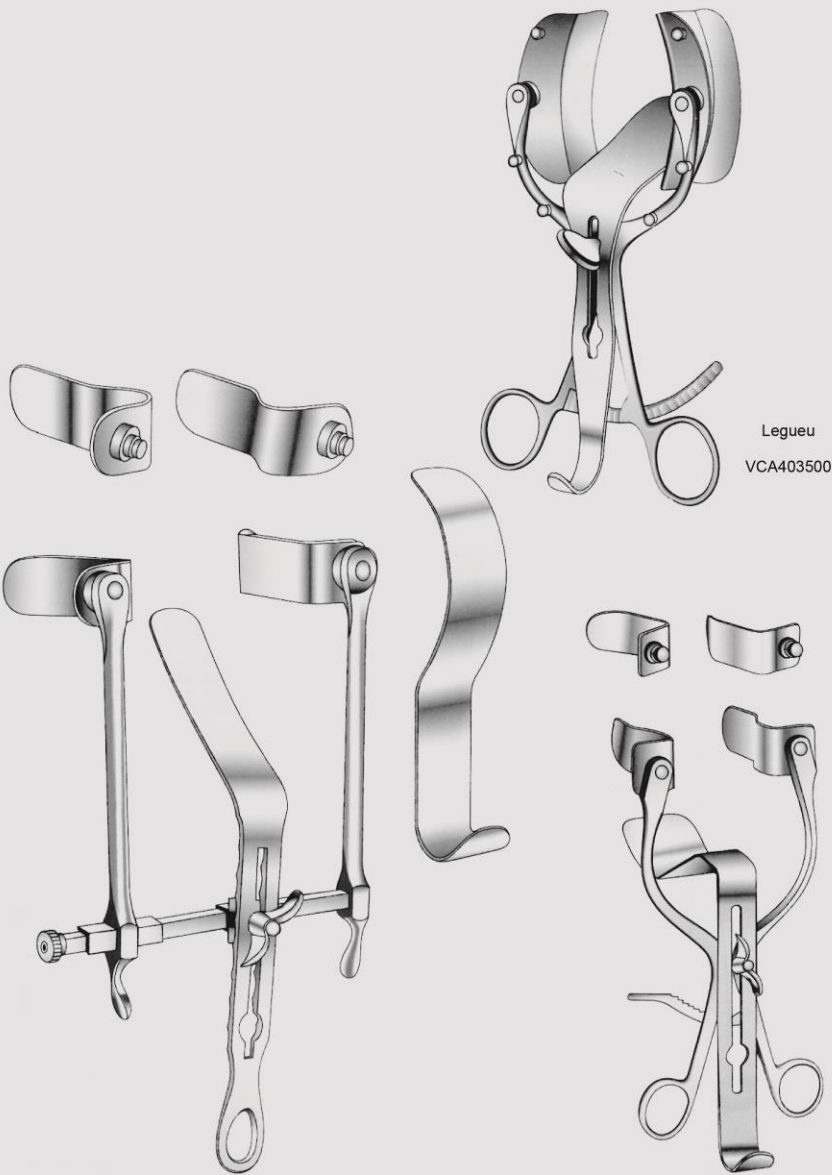
Millin
VCA402500
29 cm / 11½"



Millin
VCA403000



Urology
Bladder Retractors
Blasenwundsperrer
Separadores vesicales



Legueu
VCA403500

Thomson-Walker
VCA404000

Millin
VCA404500

کلیه ، صفرا
اکارتورها



CE

SQS Certificate
ISO 9001:2000
ISO 13485:2003

629



Urology
Bladder Retractors
Blasenwundsperrer
Separadores vesicales

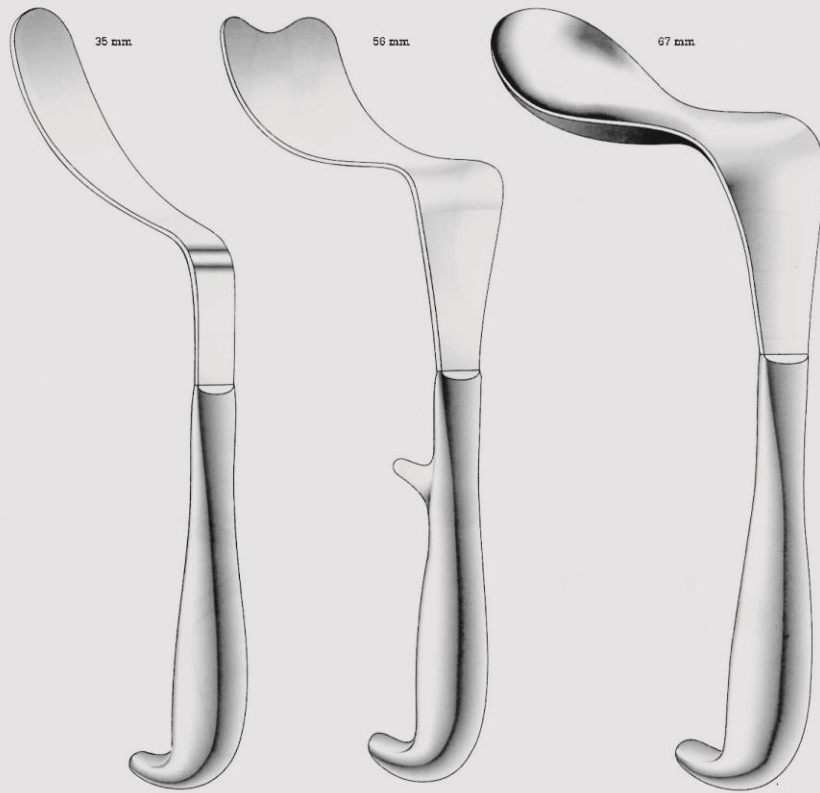
ارولوژی
اکارتورها



CE

SQS Certificate
ISO 9001:2000
ISO 13485:2003

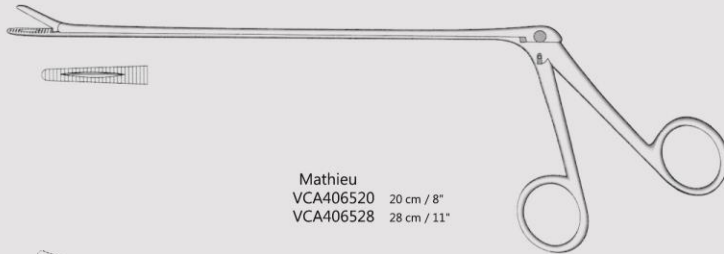
630



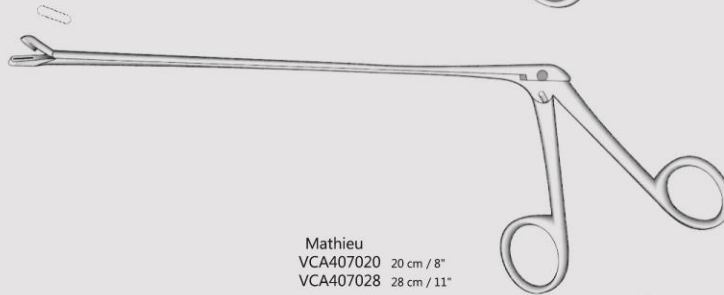
Legueu
VCA405027
27 cm / 10 $\frac{3}{4}$ "

Kocher
VCA405526
26 cm / 10 $\frac{1}{4}$ "

Kocher
VCA406026
26 cm / 10 $\frac{1}{4}$ "



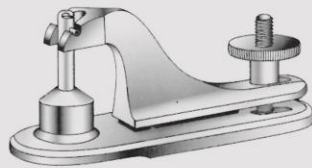
Mathieu
VCA406520 20 cm / 8"
VCA406528 28 cm / 11"



Mathieu
VCA407020 20 cm / 8"
VCA407028 28 cm / 11"



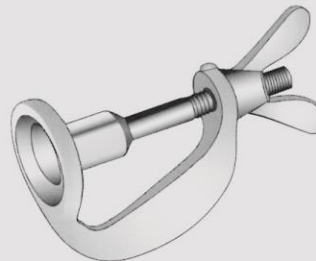
VCA408016
16 cm / 6 1/4"



VCA408500 8 mm \emptyset
VCA408600 11 mm \emptyset
VCA408700 13 mm \emptyset
VCA408800 16 mm \emptyset
VCA408900 21 mm \emptyset
VCA409000 26 mm \emptyset
VCA409100 32 mm \emptyset



Mogen
VCA407507
7 cm / 2 3/4"



Winkelmann
VCA409500 12 mm \emptyset
VCA409600 16 mm \emptyset
VCA409700 20 mm \emptyset
Circumcision clamps



Urology
Foreign Body Forceps & Circumcision
Fremdkorperzangen und Circumcisions
Pinzas para cuerois extrabos Y circuncision

اورولوژی



CE

SQS Certificate
ISO 9001:2000
ISO 13485:2003

631



Urology

Hernia Directors, Suction Tube
Sonden, Aspirationskanulen
Sondas, Canulas de aspiracion

ارولوژی



CE

SQS Certificate
ISO 9001:2000
ISO 13485:2003

632



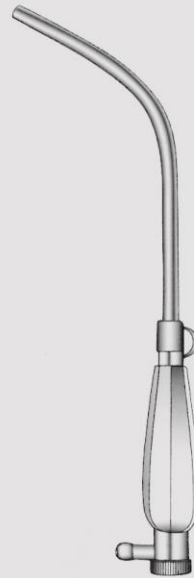
Child
VCA410100



Key
VCA410500



Teale
VCA411000



Millin
VCA411500

Millin



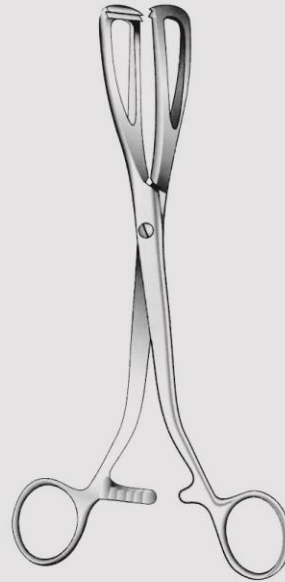
Urology
Lithotomy Forceps and Penis Clamp
Steinzangen Und Penisklemmen
Pinza/litotomia y Compresores Uretrales



Lewkowitz
VCA412026
26 cm / 10³/₄"



VCA412126
Angled



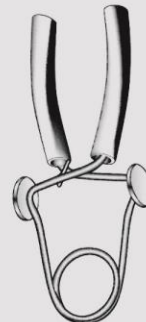
Young
VCA412520
20 cm / 8"



Thomson-Walker
VCA413000



Stockmann
VCA413500



Strauss
VCA414000

ارولوژی، پنس



CE

SQS Certificate
ISO 9001:2000
ISO 13485:2003

633



Urology
Dilating Bougies
Dilatationsbougies
Bugiasdilatador

اورولوژی
بنيکه



SQS Certificate
ISO 9001:2000
ISO 13485:2003

634

<p>Fr.</p> <p>VCA414600 00/1</p> <p>VCA414700 0/2</p> <p>VCA414800 1/3</p> <p>VCA414900 1/4</p> <p>VCA415000 2/5</p> <p>VCA415100 3/6</p> <p>VCA415200 4/7</p> <p>VCA415300 5/8</p> <p>VCA415400 6/9</p> <p>VCA415500 7/10</p> <p>VCA415600 8/11</p> <p>VCA415700 9/12</p> <p>VCA415800 10/13</p> <p>VCA415900 11/14</p> <p>VCA416000 12/15</p> <p>VCA416100 13/16</p> <p>VCA416200 14/17</p> <p>VCA416300 15/18</p>	<p>Fr.</p> <p>VCA416600 6/10</p> <p>VCA416700 8/12</p> <p>VCA416800 10/14</p> <p>VCA416900 12/16</p> <p>VCA417000 14/18</p> <p>VCA417100 16/20</p> <p>VCA417200 18/22</p> <p>VCA417300 20/24</p> <p>VCA417400 22/26</p> <p>VCA417500 24/28</p> <p>VCA417600 26/30</p> <p>VCA417700 28/32</p>	<p>Fr.</p> <p>VCA418100 8</p> <p>VCA418200 9</p> <p>VCA418300 10</p> <p>VCA418400 11</p> <p>VCA418500 12</p> <p>VCA418600 13</p> <p>VCA418700 14</p> <p>VCA418800 15</p> <p>VCA418900 16</p> <p>VCA419000 17</p> <p>VCA419100 18</p> <p>VCA419200 19</p> <p>VCA419300 20</p> <p>VCA419400 21</p> <p>VCA419500 22</p> <p>VCA419600 23</p> <p>VCA419700 24</p> <p>VCA419800 25</p> <p>VCA419900 26</p> <p>VCA420000 27</p> <p>VCA420100 28</p> <p>VCA420200 29</p> <p>VCA420300 30</p> <p>VCA420400 32</p> <p>VCA420500 34</p> <p>VCA420600 36</p>	<p>Fr.</p> <p>VCA421000</p> <p>VCA421200</p> <p>VCA421300</p> <p>VCA421400</p> <p>VCA421500</p> <p>VCA421600</p> <p>VCA421700</p> <p>VCA421800</p> <p>VCA421900</p> <p>VCA422000</p> <p>VCA422100</p> <p>VCA422200</p> <p>VCA422300</p> <p>VCA422400</p> <p>VCA422500</p> <p>VCA422600</p> <p>VCA422700</p> <p>VCA422800</p> <p>VCA422900</p> <p>VCA423000</p> <p>VCA423100</p> <p>VCA423200</p> <p>VCA423300</p> <p>VCA423400</p> <p>VCA423500</p>
--	--	--	---

Lister
VCA414500
Set

Clutton
VCA416500
Set

Ven Buren
VCA418000
Set

Fr.

VCA440000 8

VCA440100 9

VCA440200 10

VCA440300 11

VCA440400 12

VCA440500 13

VCA440600 14

VCA440700 15

VCA440800 16

VCA440900 17

VCA441000 18

VCA441100 19

VCA441200 20

VCA441300 21

VCA441400 22

VCA441500 23

VCA441600 24

VCA441700 25

VCA441800 26

VCA441900 27

VCA442000 28

VCA442100 29

VCA442200 30

Dittel
VCA424500
Set



Urology
Dilating Bougies
Dilatationsbougies
Bugiasdilator



Guyon
CA425000
Set of 29; Fig. 8 - Fig. 36

VCA425500	Fr. 08	VCA427000	Fr. 19	VCA428500	Fr. 30
VCA425600	Fr. 09	VCA427100	Fr. 20	VCA428600	Fr. 31
VCA425700	Fr. 10	VCA427200	Fr. 21	VCA428700	Fr. 32
VCA425800	Fr. 11	VCA427300	Fr. 22	VCA428800	Fr. 33
VCA425900	Fr. 12	VCA427400	Fr. 23	VCA428900	Fr. 34
VCA426000	Fr. 13	VCA427500	Fr. 24	VCA429000	Fr. 35
VCA426100	Fr. 14	VCA427600	Fr. 25	VCA429100	Fr. 36
VCA426200	Fr. 15	VCA427700	Fr. 26		
VCA426300	Fr. 16	VCA427800	Fr. 27		
VCA426400	Fr. 17	VCA427900	Fr. 28		
VCA426500	Fr. 18	VCA428000	Fr. 29		

اورولوژی
بنیکه



CE

SQS Certificate
ISO 9001:2000
ISO 13485:2003

635



Urology

Metal Catheters and Catheter Guide
Metall katheter und Katheterspanner
Sondas metálicas Y Mandril para Sondas

ارولوژی
سوندها



CE

SQS Certificate
ISO 9001:2000
ISO 13485:2003

636



Male

VCA429527 Fig.06
 VCA429627 Fig.07
 VCA429727 Fig.08
 VCA429827 Fig.09
 VCA429927 Fig.10
 VCA430027 Fig.11
 VCA430127 Fig.12
 VCA430227 Fig.13
 VCA430327 Fig.14
 VCA430427 Fig.15
 VCA430527 Fig.16
 VCA430627 Fig.17
 VCA430727 Fig.18
 VCA430827 Fig.19
 VCA430927 Fig.20
 VCA431027 Fig.21
 VCA431127 Fig.22
 VCA431227 Fig.23
 VCA431327 Fig.24
 27 cm / 10½"

Coxeter

VCA432028 Fig.06
 VCA432128 Fig.07
 VCA432228 Fig.08
 VCA432328 Fig.09
 VCA432428 Fig.10
 VCA432528 Fig.11
 VCA432628 Fig.12
 VCA432728 Fig.13
 VCA432828 Fig.14
 VCA432928 Fig.15
 VCA433028 Fig.16
 VCA433128 Fig.17
 VCA433228 Fig.18
 VCA433328 Fig.19
 VCA433428 Fig.20
 VCA433528 Fig.21
 VCA433628 Fig.22
 VCA433728 Fig.23
 VCA433828 Fig.24
 28 cm / 11"

Female

VCA434015 Fig.06
 VCA434115 Fig.07
 VCA434215 Fig.08
 VCA434315 Fig.09
 VCA434415 Fig.10
 VCA434515 Fig.11
 VCA434615 Fig.12
 VCA434715 Fig.13
 VCA434815 Fig.14
 VCA434915 Fig.15
 VCA435015 Fig.16
 VCA435115 Fig.17
 VCA435215 Fig.18
 VCA435315 Fig.19
 VCA435415 Fig.20
 VCA435515 Fig.21
 VCA435615 Fig.22
 VCA435715 Fig.23
 VCA435815 Fig.24
 15 cm / 6"

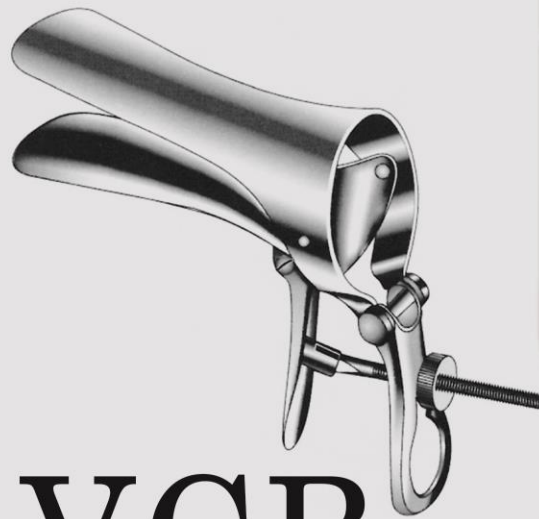
Female

VCA436020 Fig.06
 VCA436120 Fig.07
 VCA436220 Fig.08
 VCA436320 Fig.09
 VCA436420 Fig.10
 VCA436520 Fig.11
 VCA436620 Fig.12
 VCA436720 Fig.13
 VCA436820 Fig.14
 VCA436920 Fig.15
 VCA437020 Fig.16
 VCA437120 Fig.17
 VCA437220 Fig.18
 VCA437320 Fig.19
 VCA437420 Fig.20
 VCA437520 Fig.21
 VCA437620 Fig.22
 VCA437720 Fig.23
 VCA437820 Fig.24
 20 cm / 8"

Guyon
 VCA438039
 39 cm / 15½"

VCA438535
 35 cm / 13¾"

DIAMOND SURGICAL
WWW.DIAMONDMED.IR INSTRUMENTS



VCB
Gynecology



CE

SQS Certificate
ISO 9001:2000
ISO 13485:2003

637

www.Diamondmed.ir



Gynecology
Vaginal Specula and Retractors
Scheidenspekula und halter
Especulos Y Valvas Vaginales

اسپیکلوم
زنان



CE

SQS Certificate
ISO 9001:2000
ISO 13485:2003

638



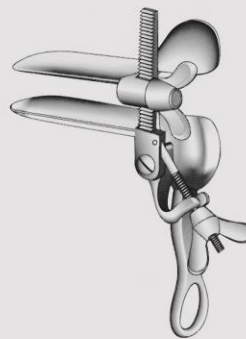
Cusco
VCB3001100 75 x 32 mm
VCB3002200 88 x 35 mm
VCB3003300 100 x 37 mm
Central screw, swiss pattern

Cusco
VCB3005500 90 x 22 mm
VCB3006600 100 x 25 mm
VCB3007700 105 x 27 mm
Swiss pattern

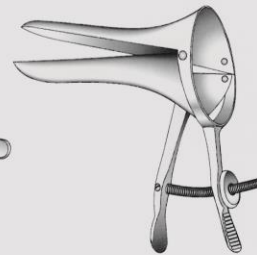
Cusco
VCB301000 75 x 32 mm
VCB3011100 85 x 35 mm
VCB3012200 100 x 37 mm
With close end



Cusco
VCB3015500
75 x 17 mm



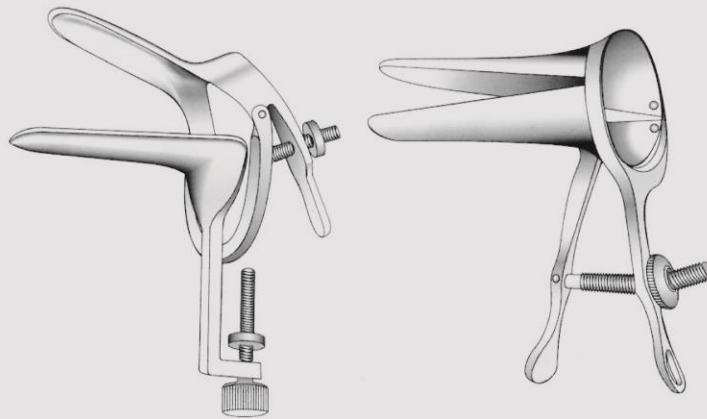
Trelat
VCB302000 85 x 33 mm
VCB3021100 95 x 35 mm
VCB3022200 115 x 43 mm



Cusco
Japanese model
VCB3025500 Small
VCB3026600 Medium
VCB3027700 Large
Stainless steel forged handle
VCB3030000 Small
VCB3031100 Medium
VCB3032200 Large
Stainless steel sheet handle



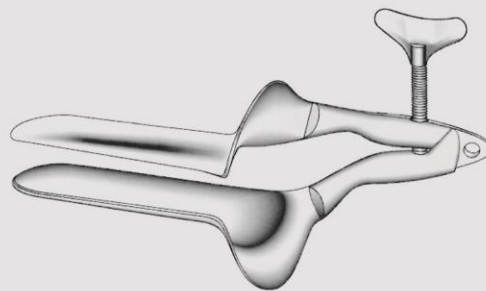
Gynecology
Vaginal Specula
Scheidenspekula
Especulos Vaginales



Clum
VCB303500
Sakurai's vaginal speculum

Cusco
VCB304000 Small
VCB304100 Medium
VCB304200 Large

زنان و زایمان
اسپیکلوم ها



Collin
VCB304500 85 x 30 mm
VCB304600 100 x 35 mm
VCB304700 110 x 40 mm
German sizes
VCB305000 16 x 90 mm
VCB305100 26 x 90 mm
VCB305200 30 x 90 mm
VCB305300 32 x 105 mm
VCB305400 35 x 105 mm
VCB305500 38 x 105 mm
French sizes



CE

SQS Certificate
ISO 9001:2000
ISO 13485:2003

639



Gynecology
Vaginal Specula and Retractors
Scheidenspekula und halter
Especulos Y Valvas Vaginales

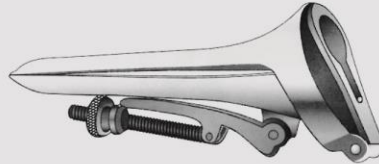
زنان و زایمان
اسپکلوم ها



CE

SQS Certificate
ISO 9001:2000
ISO 13485:2003

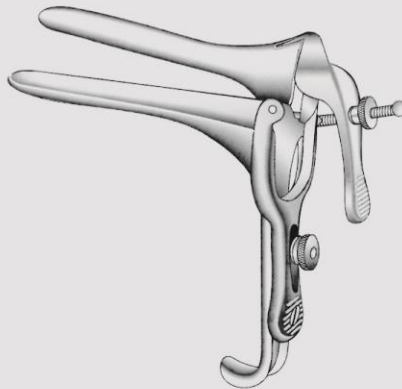
640



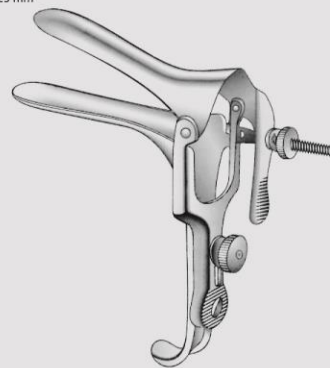
Cusco Pliant
VCB306000 16 x 100 mm
VCB306100 20 x 100 mm
VCB306200 25 x 100 mm
VCB306300 28 x 100 mm
VCB306400 30 x 100 mm
VCB306500 32 x 100 mm
VCB306600 36 x 100 mm



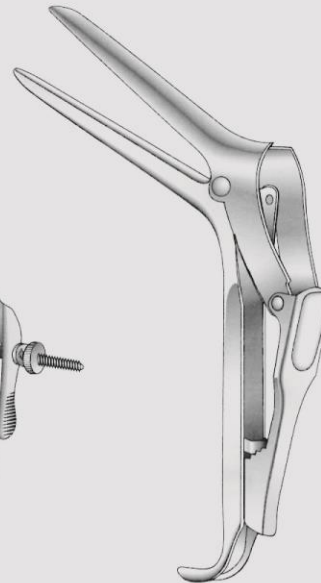
Cusco Fixe
VCB307000 16 x 100 mm
VCB307100 25 x 100 mm
VCB307200 32 x 100 mm
VCB307300 35 x 100 mm
VCB307400 40 x 100 mm



Pederson
VCB308000 75 x 13 mm
VCB308100 100 x 22 mm
VCB308200 120 x 25 mm



Grave
VCB308500 75 x 20 mm
VCB308600 95 x 35 mm
VCB308700 115 x 35 mm



Semm
VCB309000 100 x 17 / 20 mm
VCB309100 100 x 25 / 30 mm



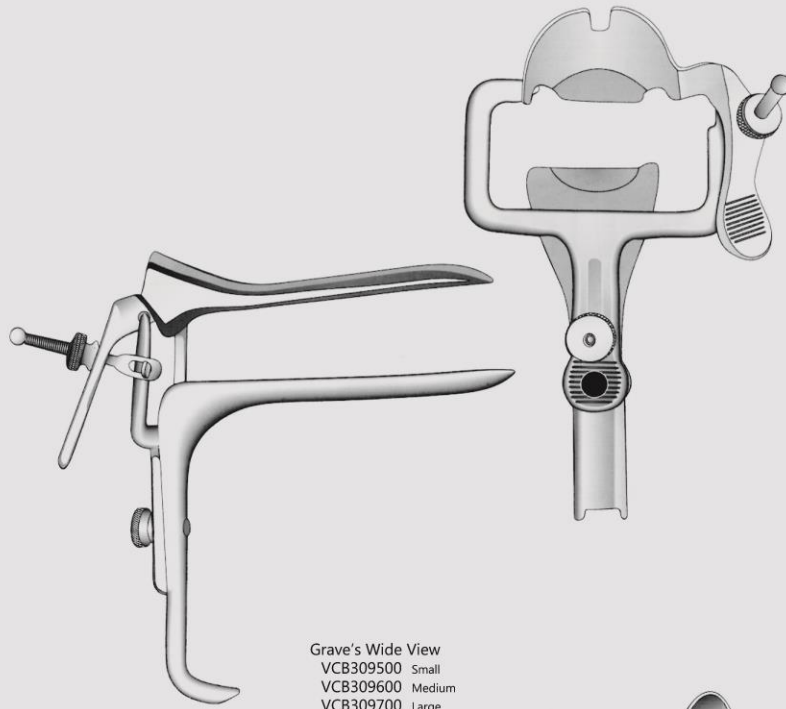
Gynecology
Vaginal Specula
Scheidenspekula
Especulos Vaginales

زنان و زایمان
اسپکلوم ها

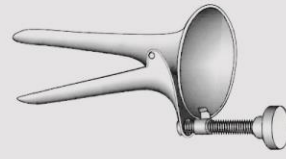


SQS Certificate
ISO 9001:2000
ISO 13485:2003

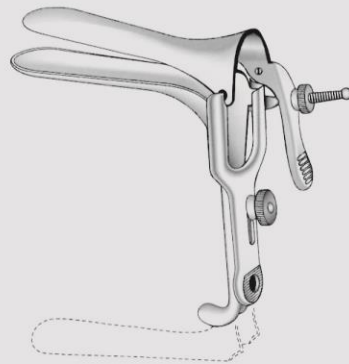
641



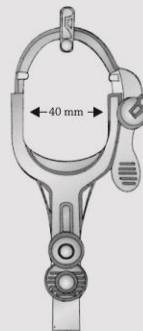
Grave's Wide View
VCB309500 Small
VCB309600 Medium
VCB309700 Large



Collin
VCB310500
65 x 10 mm



VU-More
Grave



VU-More
VCB310100 Small
VCB310200 Medium
VCB310300 Large



Gynecology
Vaginal Specula
Scheidenspekula
Especulos Vaginales

زنان و زایمان
اسپکلوم ها



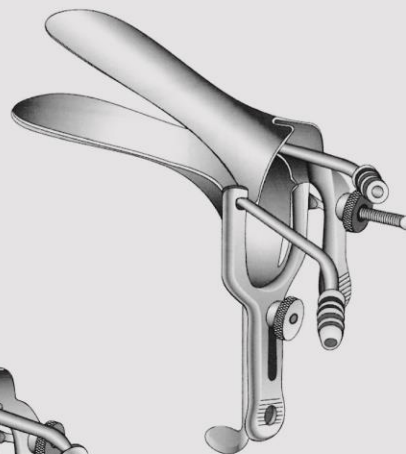
CE

SQS Certificate
ISO 9001:2000
ISO 13485:2003

642



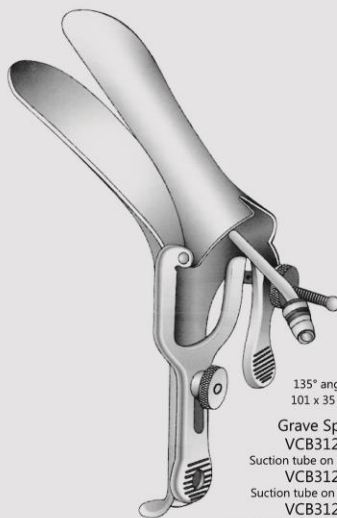
Grave
VCB311500 76 x 13 mm
VCB311600 101 x 22 mm
VCB311700 120 x 35 mm
Suction tube on lower blade



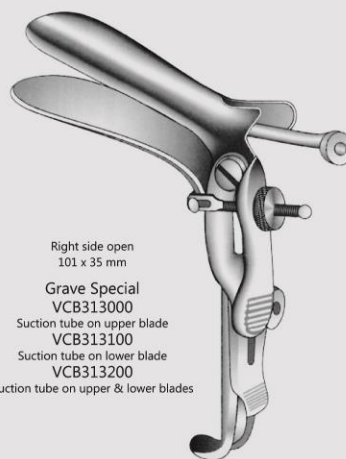
Grave
VCB312000 76 x 13 mm
VCB312100 101 x 22 mm
VCB312200 120 x 35 mm
Suction tubes on lower & upper blade



Grave
VCB311000 76 x 13 mm
VCB311100 101 x 22 mm
VCB311200 120 x 35 mm
Suction tube on upper blade



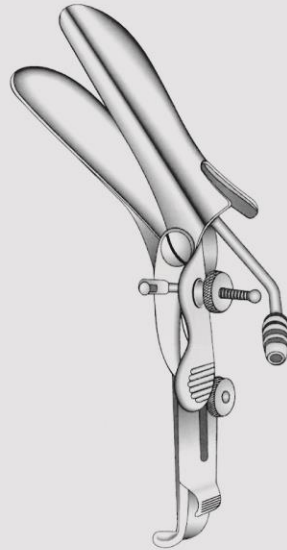
135° angled
101 x 35 mm
Grave Special
VCB312500
Suction tube on upper blade
VCB312600
Suction tube on lower blade
VCB312700
Suction tube on upper & lower blades



Right side open
101 x 35 mm
Grave Special
VCB313000
Suction tube on upper blade
VCB313100
Suction tube on lower blade
VCB313200
Suction tube on upper & lower blades

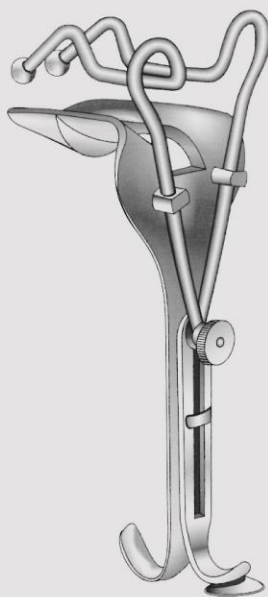


Gynecology
Vaginal Specula
Scheidenspekula
Especulos Vaginales

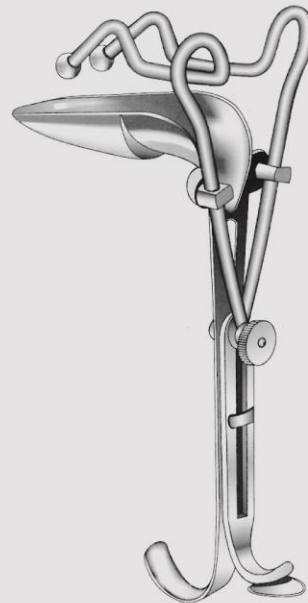


135° angled & right side open
101 x 35 mm
Grave Special
VCB313500
Suction tube on upper blade
VCB313600
Suction tube on lower blade
VCB313700
Suction tube on upper & lower blades

زنان و زایمان
اسپکلوم ها



Guttman
VCB314000
80 x 45 mm



Guttman
VCB314500
90 x 35 mm



CE

SQS Certificate
ISO 9001:2000
ISO 13485:2003

643



Gynecology
Vaginal Specula and Retractors
Scheidenspekula und halter
Especulos Y Valvas Vaginales

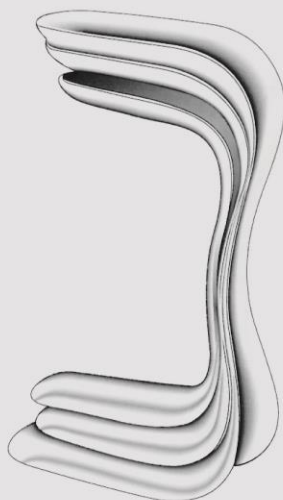
زنان و زایمان
والوها



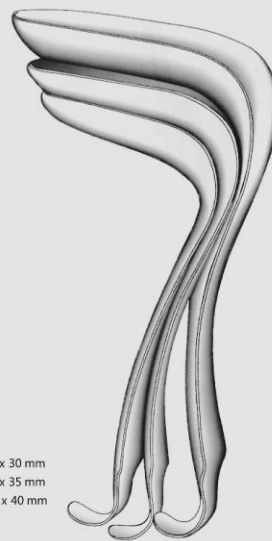
CE

SQS Certificate
ISO 9001:2000
ISO 13485:2003

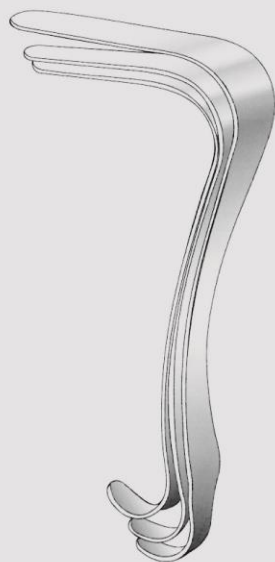
644



Sims
VCB315000 65 x 25 mm, 75 x 30 mm
VCB315100 70 x 30 mm, 70 x 35 mm
VCB315200 85 x 35 mm, 90 x 40 mm



Kristeller
VCB315500 70 x 27 mm
VCB315600 80 x 30 mm
VCB315700 90 x 36 mm
Specula



Kristeller
VCB316000 75 x 23 mm
VCB316100 85 x 26 mm
VCB316200 100 x 32 mm
Retractors

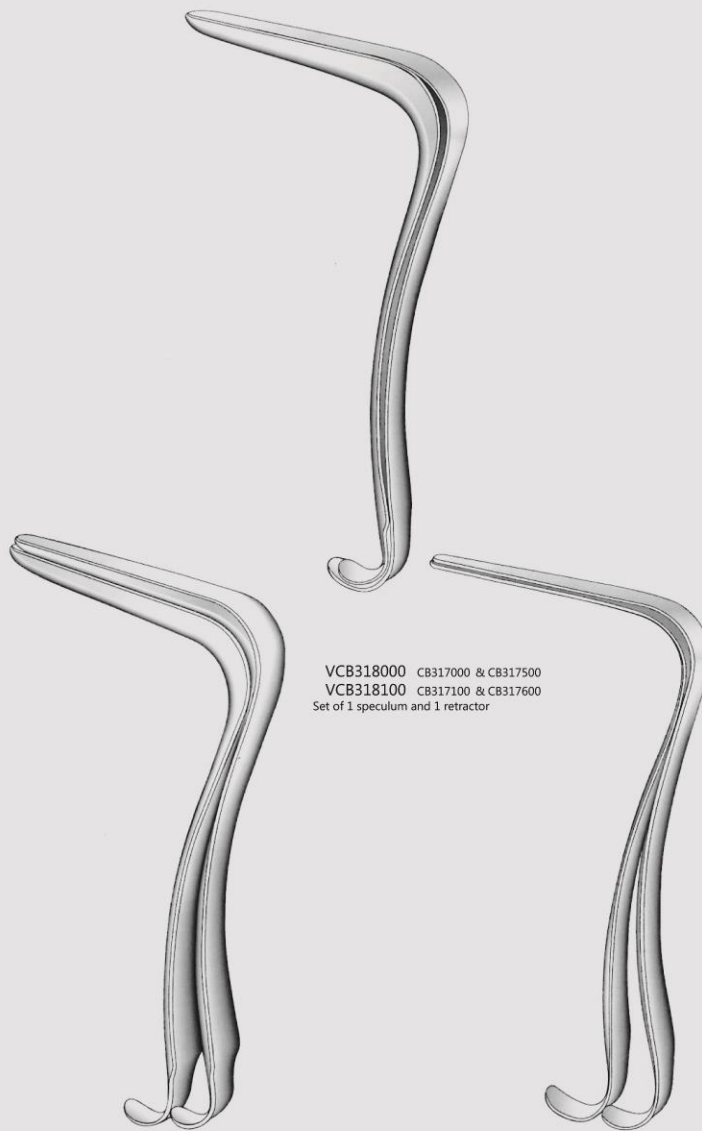


Kristeller
VCB316500 VCB315500 VCB316000
VCB316600 VCB315600 VCB316100
VCB316700 VCB315700 VCB316200
Set of 1 speculum and 1 retractor



Gynecology
Vaginal Specula
Scheidenspekula
Especulos Vaginales

والوزنان



VCB318000 CB317000 & CB317500
VCB318100 CB317100 & CB317600
Set of 1 speculum and 1 retractor

Kristeller
VCB317000 105 x 18 mm
VCB317100 105 x 21 mm
Specula

Kristeller
VCB317500 110 x 14 mm
VCB317600 110 x 17 mm
Retractors



CE

SQS Certificate
ISO 9001:2000
ISO 13485:2003

645

www.Diamondmed.ir



Gynecology
Vaginal Specula and Retractors
Scheidenspekula und halter
Especulos Y Valvas Vaginales

زنان و زایمان
والو



CE

SQS Certificate
ISO 9001:2000
ISO 13485:2003

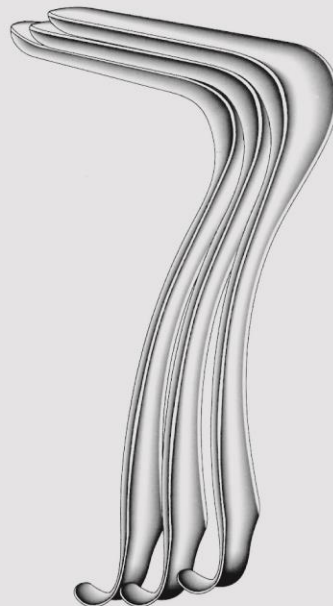
646



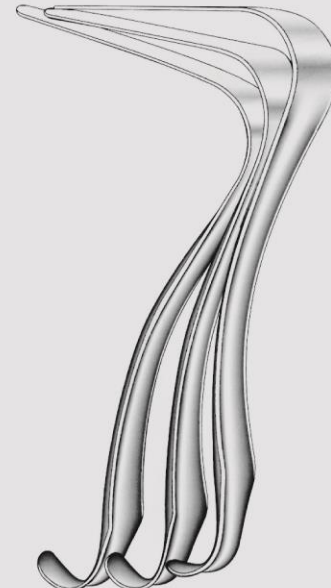
Specula flat hollow



Kristeller
VCB319500 CB318500 & CB319000
VCB319600 CB318600 & CB319100
VCB319700 CB318700 & CB319200
Set of 1 speculum and 1 retractor



Kristeller
VCB318500 105 x 26 mm
VCB318600 105 x 28 mm
VCB318700 105 x 33 mm
Specula



Kristeller
VCB319000 115 x 22 mm
VCB319100 115 x 24 mm
VCB319200 115 x 29 mm
Retractors



Gynecology
Vaginal Specula and Retractors
Scheidenspekula und halter
Especulos Y Valvas Vaginales

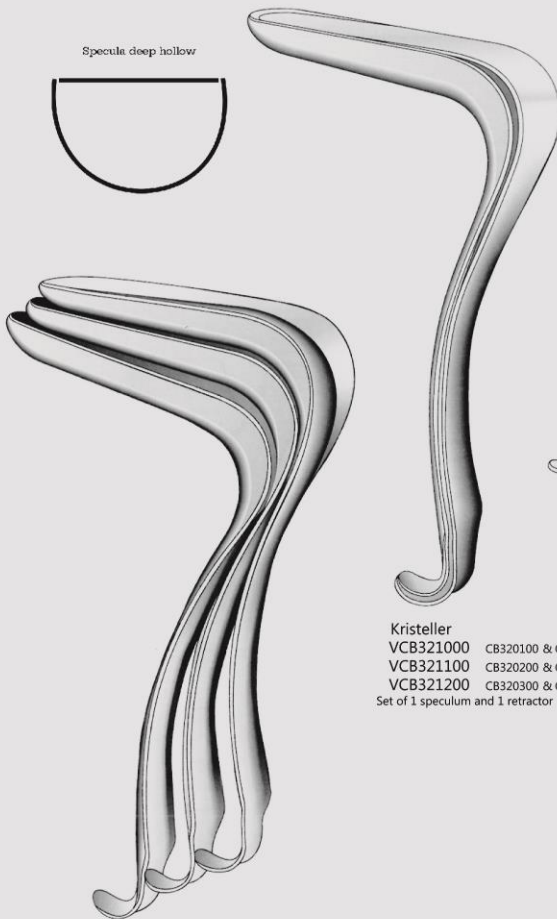
زنانه ، والو



SQS Certificate
ISO 9001:2000
ISO 13485:2003

647

Specula deep hollow



Kristeller
VCB321000 CB320100 & CB320500
VCB321100 CB320200 & CB320600
VCB321200 CB320300 & CB320700
Set of 1 speculum and 1 retractor

Kristeller
VCB320100 110 x 27 mm
VCB320200 110 x 30 mm
VCB320300 110 x 36 mm
Specula

Kristeller
VCB320500 115 x 23 mm
VCB320600 115 x 26 mm
VCB320700 115 x 32 mm
Retractors



Gynecology
Vaginal Specula and Retractors
Scheidenspekula und halter
Especulos Y Valvas Vaginales

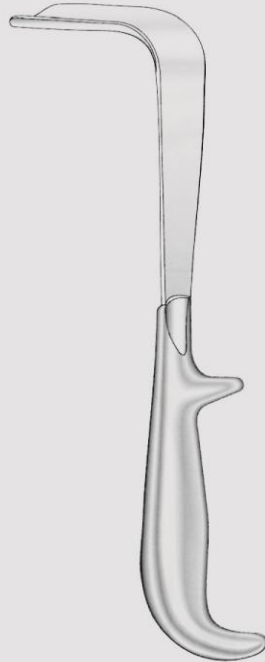
زنان
اکار تورها



CE

SQS Certificate
ISO 9001:2000
ISO 13485:2003

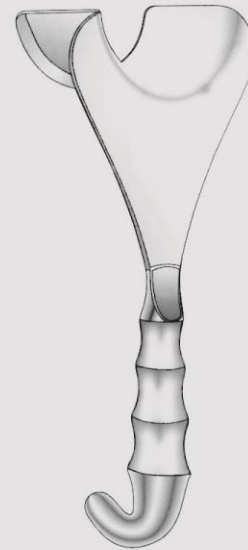
648



Doyen
Slightly-Concave
VCB321500

VCB322000	55 x 35 mm
VCB322100	58 x 35 mm
VCB322200	115 x 35 mm
VCB322300	55 x 45 mm
VCB322400	85 x 45 mm
VCB322500	115 x 45 mm
VCB322600	160 x 45 mm
VCB322700	55 x 60 mm
VCB322800	85 x 60 mm
VCB322900	115 x 60 mm
VCB323000	160 x 60 mm

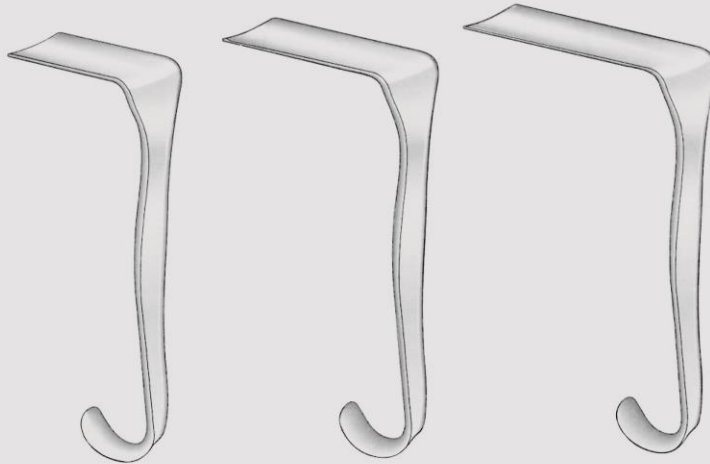
Slightly-concave



De Lee Universal Retractor
VCB323524
24 cm / 9½"
Blade 2¼" x 2"



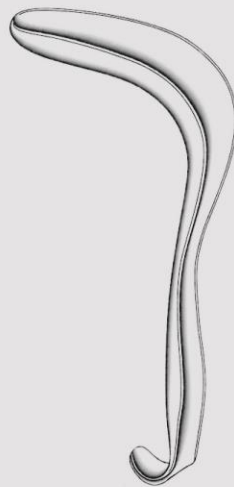
Gynecology
Vaginal Specula
Scheidenspekula
Especulos Vaginales



Jackson
VCB324000
75 x 38 mm

Jackson
VCB324500
90 x 38 mm

Jackson
VCB325000
100 x 38 mm



Sims
VCB325500
Single ended
VCB325600 Small, 2½" x 1"
VCB325700 Medium, 3" x 1¼"
VCB325800 Large, 3½" x 1½"

اکارتور زنان



CE

SQS Certificate
ISO 9001:2000
ISO 13485:2003

649



Gynecology
Vaginal Specula and Retractors
Scheidenspekula und Halter
Especulos Y Valvas Vaginales

زنان و زایمان
اکار تورها



CE

SQS Certificate
ISO 9001:2000
ISO 13485:2003



Kallmorgen
VCB326000 70 x 40 mm
VCB326100 90 x 40 mm
Vaginal specula



Kallmorgen
VCB326500
VCB326600
Vaginal retractors
VCB327000 CB326000 & CB326500
VCB327100 CB326100 & CB326600
Kallmorgen set



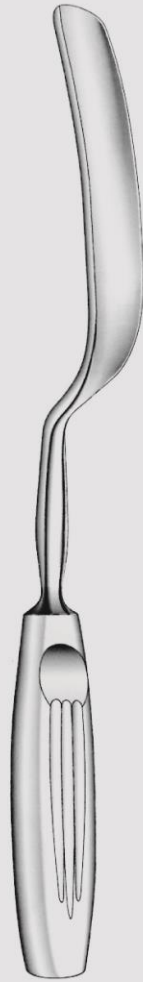
Mathieu
VCB327500 95 x 16 mm
VCB327600 95 x 26 mm
VCB327700 95 x 16 mm
VCB327800 95 x 30 mm
Vaginal specula



VCB328000 100 x 16 mm
VCB328100 100 x 20 mm
VCB328200 100 x 14 mm
VCB328300 100 x 26 mm
Vaginal retractors



Gynecology
Vaginal Specula
Scheidenspekula
Especulos Vaginales



Breisky

VCB328500	100 x 20 mm
VCB328600	100 x 25 mm
VCB328700	100 x 30 mm
VCB328800	100 x 35 mm
VCB328900	100 x 40 mm
VCB329000	130 x 20 mm
VCB329100	130 x 25 mm
VCB329200	130 x 30 mm
VCB329300	130 x 35 mm
VCB329400	130 x 40 mm
VCB329500	155 x 40 mm



Doyen
VCB329100
70 x 30 mm

زنان و زایمان
اکارتور - والو



CE

SQS Certificate
ISO 9001:2000
ISO 13485:2003

651



Gynecology
Vaginal Specula
Scheidenspekula
Especulos Vaginales

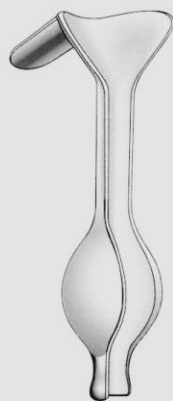
زنان و زایمان
والو



CE

SQS Certificate
ISO 9001:2000
ISO 13485:2003

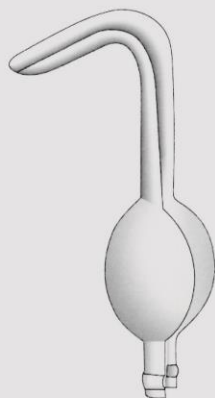
652



Auvard
VCB330500 Light 2 lbs.
VCB330600 Medium 2½ lbs.
VCB330700 Heavy 3 lbs
Weighted vaginal speculum
Blades 2¼" x 1½"



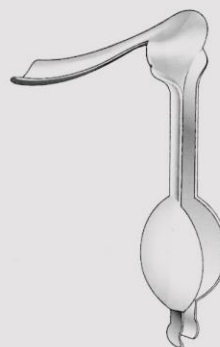
Garrigue
VCB331000 Light 2 lbs.
VCB331100 Medium 2½ lbs.
VCB331200 Heavy 3 lbs.
Weighted vaginal speculum
Blades 3" x 1½"



Henrotin
VCB331500
3 lbs.
Blade 3¾" x 1½"
Weighted vaginal speculum



Berlind-Auvard
VCB332000
2½ lbs.
Weighted vaginal speculum



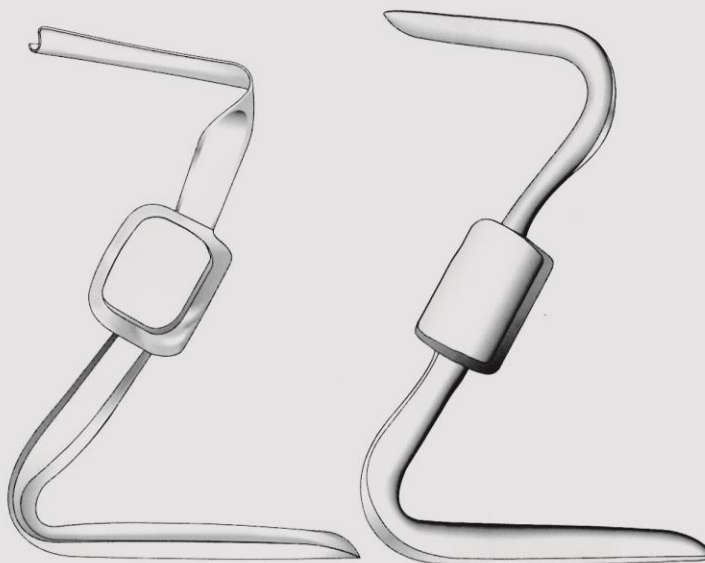
Steiner-Auvard
VCB332500
2½ lbs.
Weighted vaginal speculum



Gynecology
Vaginal Specula
Scheidenspekula
Especulos Vaginales



Jayle
VCB333000 60 x 40 mm, 60 x 40 mm
VCB333100 90 x 40 mm, 90 x 40 mm
Blade with weight



Soonawala
Vaginal specula
VCB333500
Stainless steel

Soonawla Modified
Vaginal specula
VCB334000
Stainless steel

زنان و زایمان
والو



CE

SQS Certificate
ISO 9001:2000
ISO 13485:2003

653



Gynecology
Vaginal Specula
Scheidenspekula
Especulos Vaginales

زنان و زایمان
والو



CE

SQS Certificate
ISO 9001:2000
ISO 13485:2003

654



Auvard
VCB334500
80 x 43 mm
Complete with removable weight

www.Diamondmed.ir



Gynecology
Vaginal Specula
Scheidenspekula
Especulos Vaginales



VCB336500
80 x 30 mm



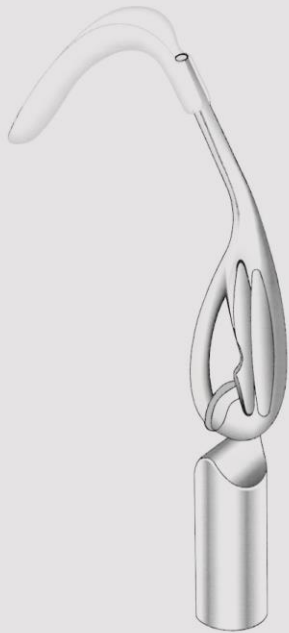
VCB336600
85 x 35 mm



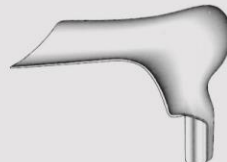
VCB336700
85 x 40 mm
Special blade, only



VCB337000
55 x 40 mm, 60 mm



VCB335500
Handle for vaginal speculum



VCB337100
70 x 45 mm, 70 mm
Special blade, only

VCB336000
Weight for vaginal speculum

Scherback
VCB335000
Set, consisting of
Handle (CB335500)
Weight (CB336000)
5 blades (CB336500 - CB337100)

زنان و زایمان
والو



CE

SQS Certificate
ISO 9001:2000
ISO 13485:2003

655



Gynecology
Vaginal Specula
Scheidenspekula
Especulos Vaginales

زنان و زایمان
والو

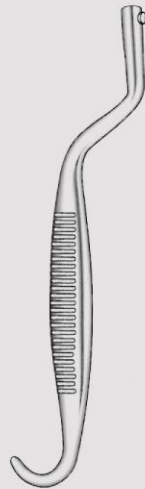


SQS Certificate
ISO 9001:2000
ISO 13485:2003

656



Bozemann
VCB337523
23 cm / 9"



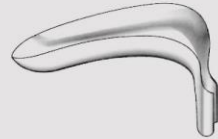
Bozemann
VCB338022
22 cm / 8 1/4"



VCB337600
80 x 30 mm



VCB337700
85 x 33 mm



VCB337800
100 x 38 mm



VCB337900
110 x 42 mm



VCB338122
65 x 30 mm



VCB338200
75 x 35 mm



VCB338300
85 x 35 mm



VCB338400
95 x 35 mm

Bozemann
Set, consisting of
2 handle (VCB337523 , VCB338022)
8 blades (VCB337600 - VCB338400)



Gynecology
Vaginal Specula
Scheidenspekula
Especulos Vaginales

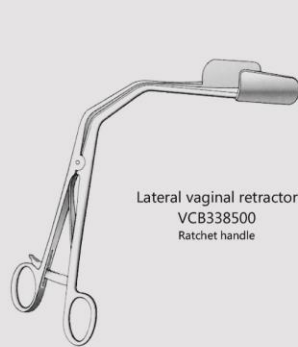
زنان و زایمان
والو



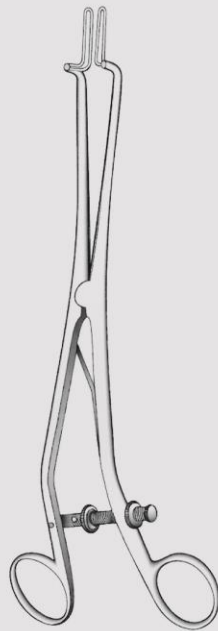
CE

SQS Certificate
ISO 9001:2000
ISO 13485:2003

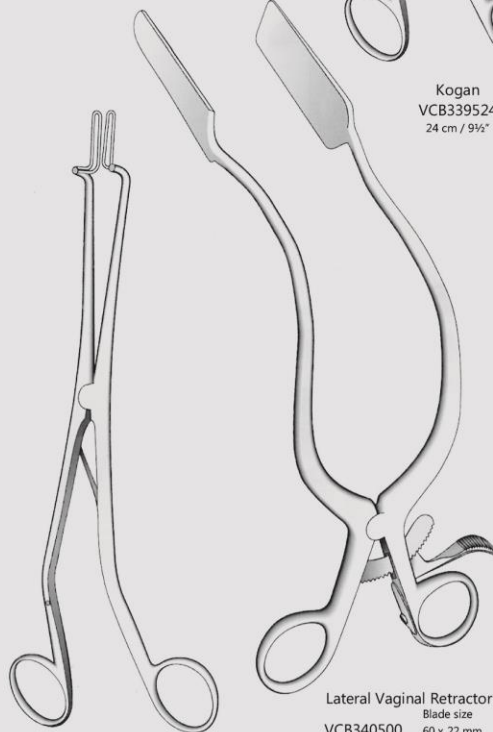
657



Lateral vaginal retractor
VCB338500
Ratchet handle

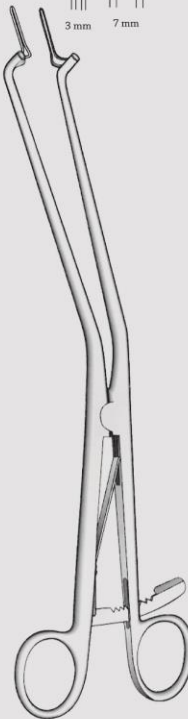


Kogan
VCB339524
24 cm / 9 1/2"



Kogan
VCB339024
24 cm / 9 1/2"

Lateral Vaginal Retractor
Blade size
VCB340500 60 x 22 mm
VCB340600 80 x 22 mm
VCB340700 100 x 22 mm
VCB340800 120 x 22 mm
With ratchet handle



Kogan
VCB340118
18 cm / 11"



Gynecology
 Vaginal Specula and Retractors
 Scheidenspekula und halter
 Especulos Y Valvas Vaginales

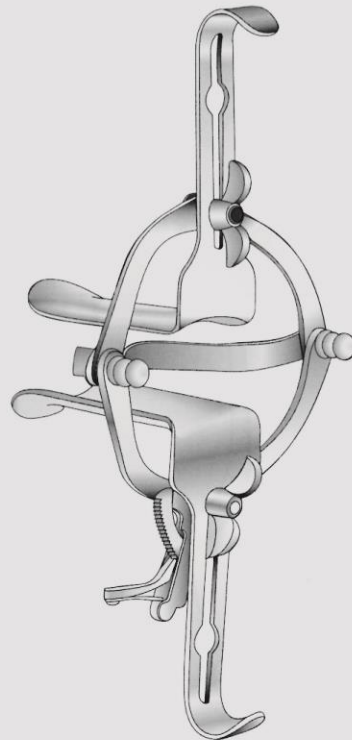
زنان و زایمان
 اکارتورها



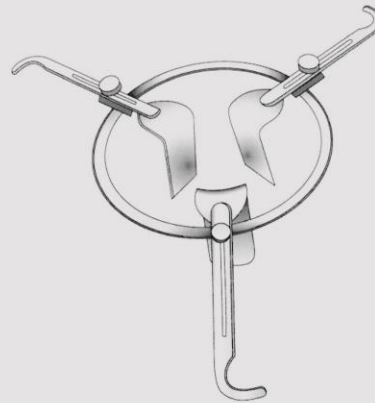
CE

SQS Certificate
 ISO 9001:2000
 ISO 13485:2003

658

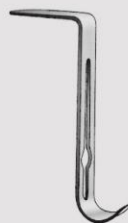


O' Sullivan-O' Connor
 VCB341500



Smith
 VCB341000

Vaginal retractor self-retaining provides adequate exposure for the obstetrical to work on the ante or post mortem cervix without an assistant. Stainless steel ring is 23 cm / 9" in diameter. Three identical stainless steel right angled retractors with blades 4.4 cm / 1 3/4" wide by 10.2 cm / 4" deep, have 20.3 cm / 8" handles, and may be placed anywhere around the ring. The angle and counter traction of the blades serve to hold the retractor securely in place.



VCB341600
 45 x 17 mm
 Fig. 1



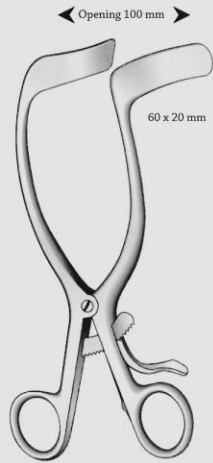
VCB341700
 90 x 37 mm
 Fig. 2



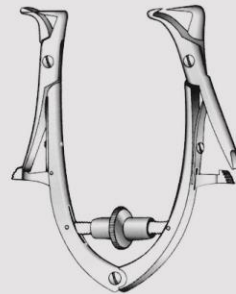
VCB341800
 90 x 45 mm
 Fig. 3



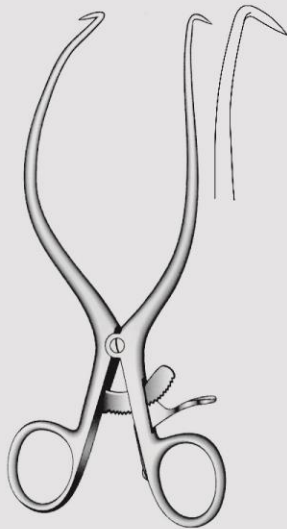
Gynecology
Wound Spreader, Self-retaining
Wundspreizer
Separadores autoestaticos



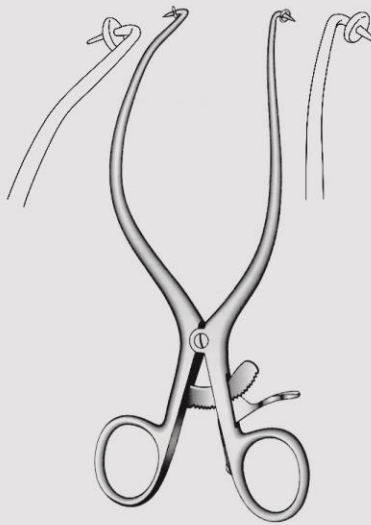
Rigby
VAE367518
18 cm / 7"



Friedman
VCB342010
10 cm / 4"
VCB342013
13 cm / 5"



Gelpi
VAE366509 9 cm / 3½"
VAE366511 11.5 cm / 4½"
VAE366514 14 cm / 5½"
VAE366516 16 cm / 6¼"
VAE366518 18 cm / 7"



Gelpi
VAE367018
18 cm / 7"

زنان و زایمان
اکارتورها



CE

SQS Certificate
ISO 9001:2000
ISO 13485:2003

659



Gynecology
Uterine Dilators
Uterus-Dilatatoren
Dilatadores Uterinos

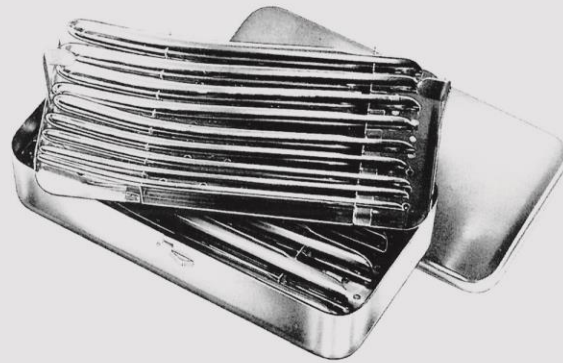
زنان و زایمان
ست بوژی
دیلاتورها



CE

SQS Certificate
ISO 9001:2000
ISO 13485:2003

660



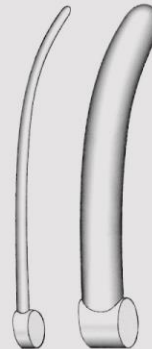
VCB344000
Set of 14 pieces
4 mm to 17 mm
VCB344100
Set of 26 pieces
1 mm to 26 mm



Hegar
Uterine dilators, single ended
with sloped handle

VCB344400
Set of 26 pieces

VCB344500	1 mm
VCB344600	2 mm
VCB344700	3 mm
VCB344800	4 mm
VCB344900	5 mm
VCB345000	6 mm
VCB345100	7 mm
VCB345200	8 mm
VCB345300	9 mm
VCB345400	10 mm
VCB345500	11 mm
VCB345600	12 mm
VCB345700	13 mm
VCB345800	14 mm
VCB345900	15 mm
VCB346000	16 mm
VCB346100	17 mm
VCB346200	18 mm
VCB346300	19 mm
VCB346400	20 mm
VCB346500	21 mm
VCB346600	22 mm
VCB346700	23 mm
VCB346800	24 mm
VCB346900	25 mm
VCB347000	26 mm



Hawkins-Amber
VCB347500
Set of 16; 3 to 18
VCB347600
Set of 16, 6 to 21



Gynecology
 Uterine Dilators
 Uterus-Dilatatoren
 Dilataores Uterinos



Hegar
 Double ended
 VCB350520
 Set of 8 dilators including
 VCB348200 VCB348600
 VCB348300 VCB348700
 VCB348400 VCB348800
 VCB348500 VCB348900
 20 cm / 7 1/2"
 Available in canvas and synthetic pouch

زنان و زایمان
 ست بوژی
 دیلاتورها



VCB348000 Set of 13 dilators
 VCB348100 1/2 mm
 VCB348200 3/4 mm
 VCB348300 5/6 mm
 VCB348400 7/8 mm
 VCB348500 9/10 mm
 VCB348600 11/12 mm
 VCB348700 13/14 mm
 VCB348800 15/16 mm
 VCB348900 17/18 mm
 VCB349000 19/20 mm
 VCB349100 21/22 mm
 VCB349200 23/24 mm
 VCB349300 25/26 mm



Pratt
 VCB349526 Set of 8, Sizes 13 through 33 French
 VCB349626 Sizes 13/15 French
 VCB349726 Sizes 17/19 French
 VCB349826 Sizes 21/23 French
 VCB349926 Sizes 25/27 French
 VCB350126 Sizes 29/31 French
 VCB350226 Sizes 33/35 French
 VCB350326 Sizes 37/39 French
 VCB350426 Sizes 41/43 French
 Double ended
 26.5 cm / 10 1/2"



CE

SQS Certificate
 ISO 9001:2000
 ISO 13485:2003

661



Gynecology

Dilating Bougies, Metal Catheters
Dilthations Bougies, Metall-Katheter
Bujas Dilatadores, Sondas Metálicas

زنان و زایمان
سوندها



CE

SQS Certificate
ISO 9001:2000
ISO 13485:2003

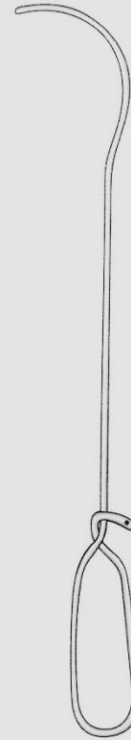
662



	Fr.	
VCA421000	8	VCA418100
VCA421100	9	VCA418200
VCA421200	10	VCA418300
VCA421300	11	VCA418400
VCA421400	12	VCA418500
VCA421500	13	VCA418600
VCA421600	14	VCA418700
VCA421700	15	VCA418800
VCA421800	16	VCA418900
VCA421900	17	VCA419000
VCA422000	18	VCA419100
VCA422100	19	VCA419200
VCA422200	20	VCA419300
VCA422300	21	VCA419400
VCA422400	22	VCA419500
VCA422500	23	VCA419600
VCA422600	24	VCA419700
VCA422700	25	VCA419800
VCA422800	26	VCA419900
VCA422900	27	VCA420000
VCA423000	28	VCA420100
VCA423100	29	VCA420200
VCA423200	30	VCA420300
VCA423300	32	VCA420400
VCA423400	34	VCA420500
VCA423500	36	VCA420600



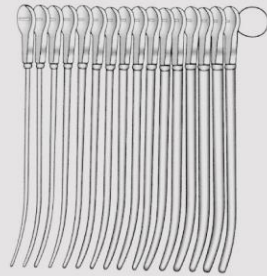
Ven Buren
VCA418000
Set



Guyon
VCB351036
36.5 cm / 14½"



Gynecology
Uterine Dilators
Uterus-Dilatatoren
Dilatadores Uterinos



Hegar
VCB351500
Set of 13
Fig. 1-13
Stainless Steel
VCB351600
Set of 13
Fig. 1-13
Chrome plated

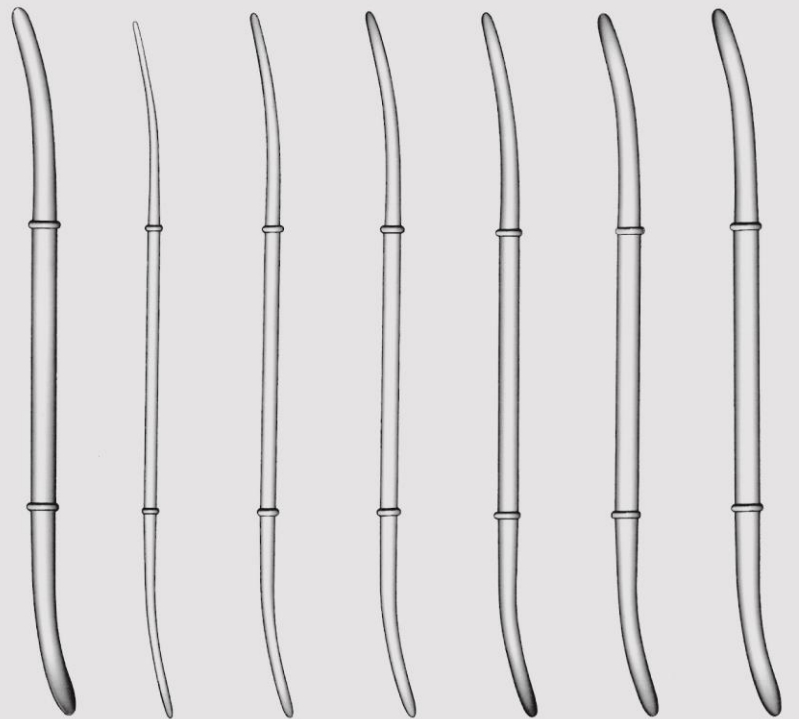
زنان و زایمان



CE

SQS Certificate
ISO 9001:2000
ISO 13485:2003

663



Hank Set
Available in canvas and
synthetic pouch
set of 6

VCB352000
4.5/5 mm^Ø
Fig. 9/10

VCB352500
5.5/6 mm^Ø
Fig. 11/12

VCB353000
6.5/7 mm^Ø
Fig. 13/14

VCB353500
7.5/8 mm^Ø
Fig. 15/16

VCB354000
8.5/9 mm^Ø
Fig. 17/18

VCB354500
9.5/10 mm^Ø
Fig. 19/20



Gynecology
Tenaculum Forceps
Hakenzangen
Pinzas Para Coger el Cuello Del Utero

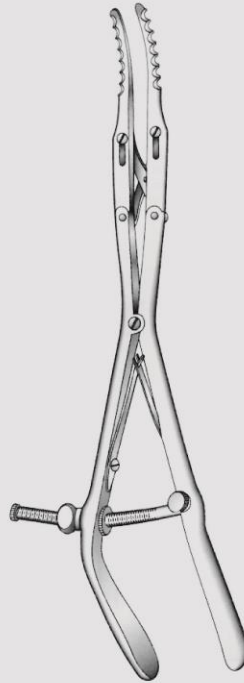
زنان و زایمان
پنس ها



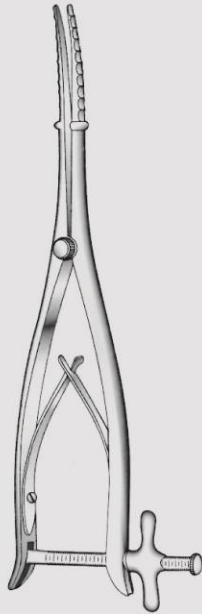
CE

SQS Certificate
ISO 9001:2000
ISO 13485:2003

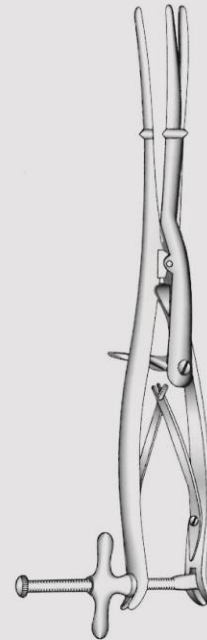
664



Goodell
VCB355034
34 cm / 13½"



Wylie
VCB355529
29 cm / 11½"



Sims
VCB356029
29 cm / 11½"



Gynecology
Tenaculum Forceps
Hakenzangen
Pinzas Para Coger el Cuello Del Utero

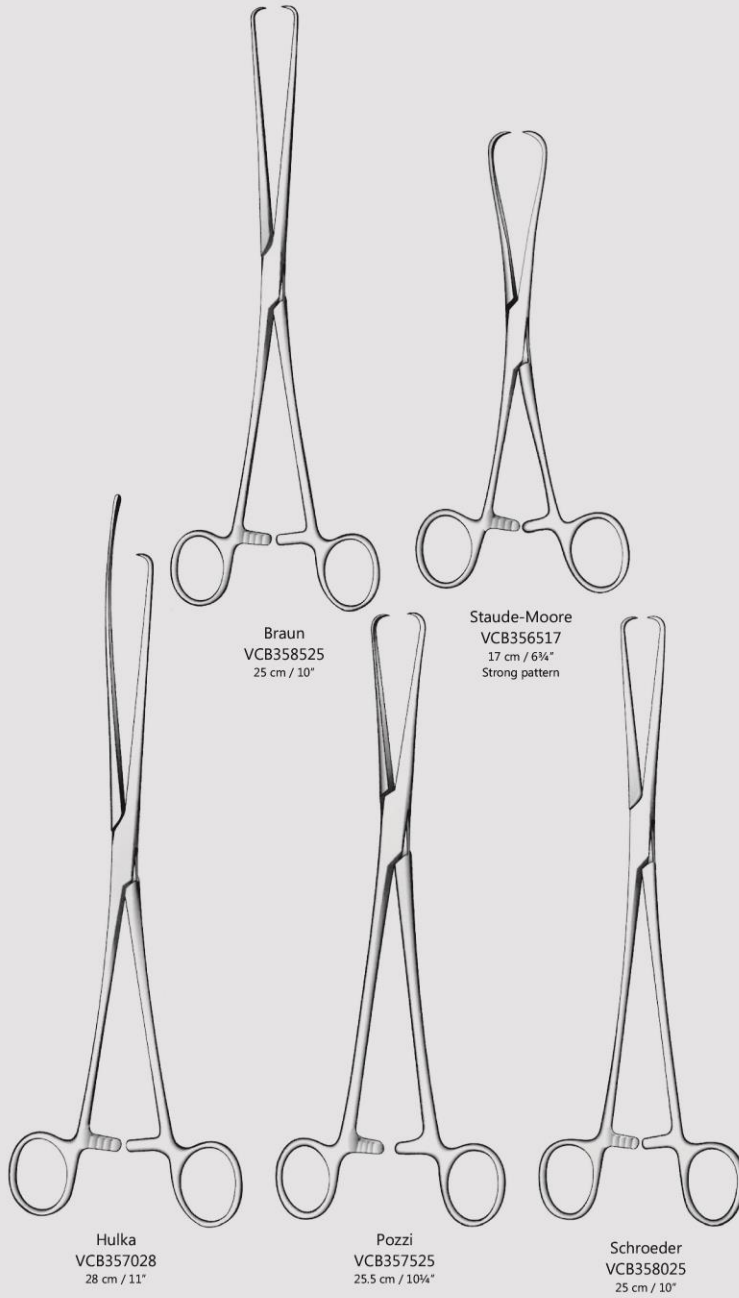
زنان و زایمان
پنس ها



CE

SQS Certificate
ISO 9001:2000
ISO 13485:2003

665



Braun
VCB358525
25 cm / 10"

Staud-Moore
VCB356517
17 cm / 6 3/4"
Strong pattern

Hulka
VCB357028
28 cm / 11"

Pozzi
VCB357525
25.5 cm / 10 1/4"

Schroeder
VCB358025
25 cm / 10"



Gynecology
Tenaculum Forceps
Hakenzangen
Pinzas Para Coger el Cuello Del Utero

زنان و زایمان
پنس ها



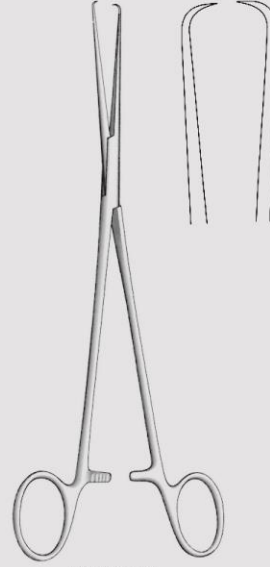
CE

SQS Certificate
ISO 9001:2000
ISO 13485:2003

666



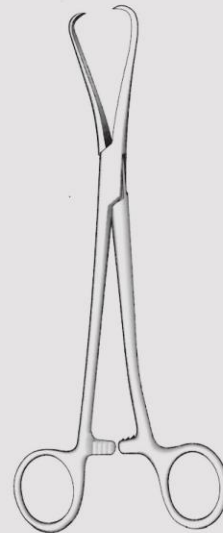
Pozzi Palmer
VCB359023
23.5 cm / 9 1/4"



Pozzi Palmer
VCB359523
23.5 cm / 9 1/4"



Barrett
VCB360118
18 cm / 7"

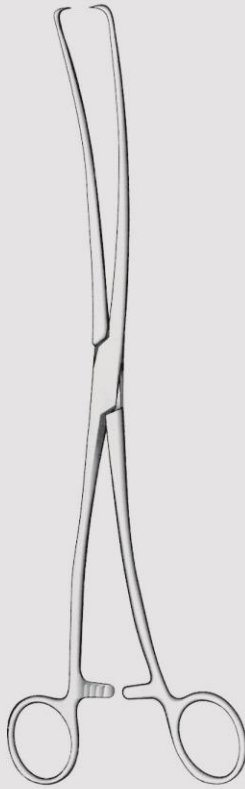


Jarcho
VCB360520
20 cm / 8"



Gynecology

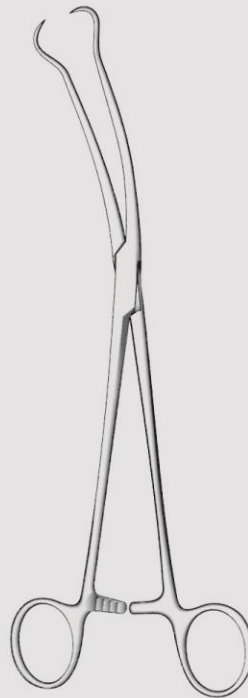
Tenaculum Forceps, Amniotome
Hakenzangen, Amniotom
Pinzas Para Cojer el Cuello Del Utero, Amniotomo



Duplay
VCB361020
20 cm / 11"



Beacham
VCB361526
26 cm / 10 1/4"
Amniotome for amnion bladder



Skene
VCB362024
24 cm / 9 1/2"
Curved sideways

زنان و زایمان
پنس ها



CE

SQS Certificate
ISO 9001:2000
ISO 13485:2003

667



Gynecology
Tenaculum Forceps
Hakenzangen
Pinzas Para Coger el Cuello Del Utero

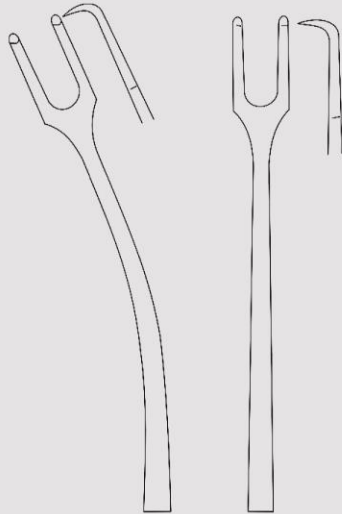
زنان و زایمان
پنس ها



CE

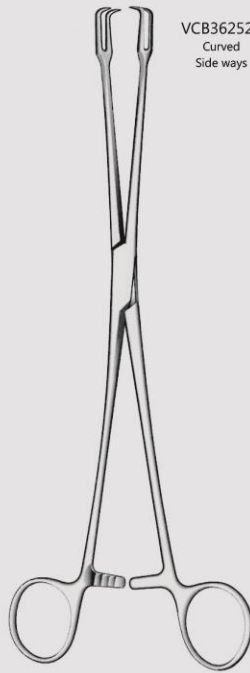
SQS Certificate
ISO 9001:2000
ISO 13485:2003

668

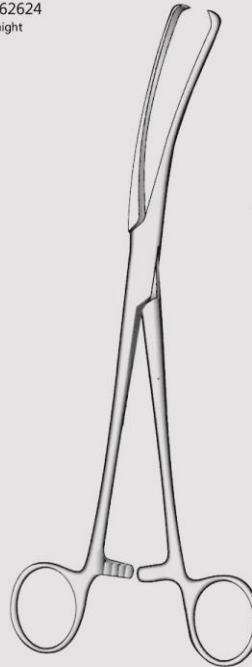


VCB362524
Curved
Side ways

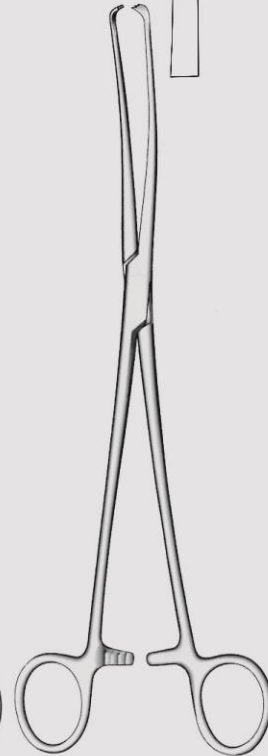
VCB362624
Straight



Schroeder
24 cm / 9½"



Teale
VCB363023
23 cm / 9"



Iowa
VCB363526
26 cm / 10¼"
For the amnion bladder



Gynecology
Tenaculum Forceps
Hakenzangen
Pinzas Para Coger el
Cuello Del Utero



VCB364600
6 mm
Straight



VCB364700
8 mm
Straight



VCB364800
10 mm
Straight



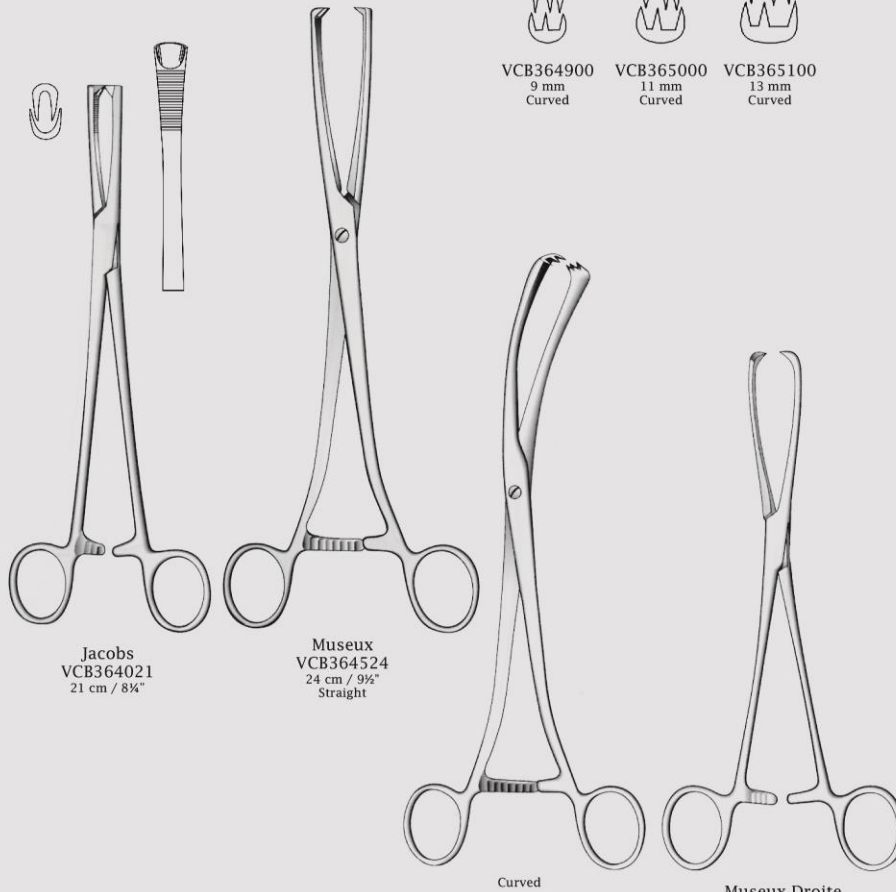
VCB364900
9 mm
Curved



VCB365000
11 mm
Curved



VCB365100
13 mm
Curved



Jacobs
VCB364021
21 cm / 8 1/4"

Museux
VCB364524
24 cm / 9 1/2"
Straight

Curved

Museux Droite
VCB365518 18cm / 7"
VCB365520 20cm / 8"
VCB365525 25cm / 10"

زنان و زایمان
پنس ها



CE

SQS Certificate
ISO 9001:2000
ISO 13485:2003

669



Gynecology
Tenaculum Forceps
Hakenzangen
Pinzas Para Coger el Cuello Del Utero

زنان و زایمان
پنسی ها



CE

SQS Certificate
ISO 9001:2000
ISO 13485:2003

670



Pratt
VCB366028
28 cm / 11"

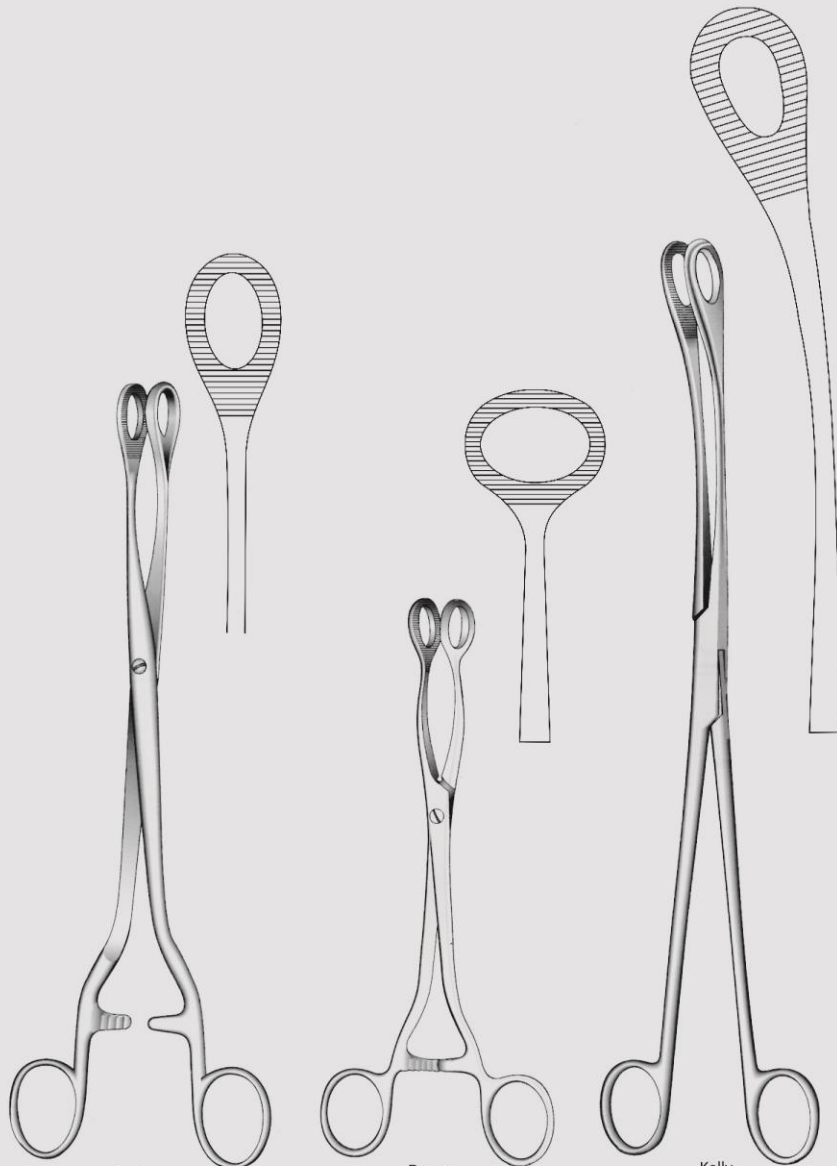
Czerny/Braun
VCB367026
26 cm / 10 1/4"

Czerny
VCB366520
20.5 cm / 8 1/4"

Braun
VCB367515
15.5 cm / 6 1/4"



Gynecology
Uterine Polypus Forceps
Uterus Polypenzangen
Pinzas Parapolipos Uterine



Noto
VCB368027
27 cm / 10½"

Doyen
VCB368520
20 cm / 8"

Kelly
VCB369032
32 cm / 12½"

زنان و زایمان
پنس ها



CE

SQS Certificate
ISO 9001:2000
ISO 13485:2003

671



Gynecology
Sponge Forceps
Schwammzangen
Pinzas para tapones

زنان و زایمان
پنس ها



CE

SQS Certificate
ISO 9001:2000
ISO 13485:2003

672



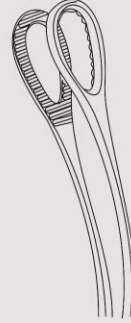
VAD305525
25 cm / 10"
Smooth jaws



VAD305618 18 cm / 7"
VAD305620 20 cm / 8"
VAD305625 25 cm / 10"



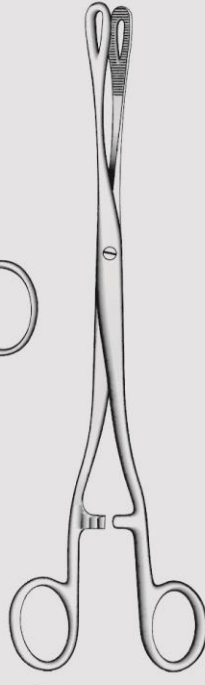
VAD305725
25 cm / 10"
Smooth jaws



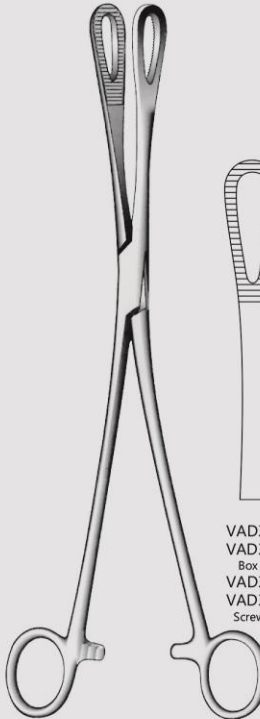
VAD305818 18 cm / 7"
VAD305820 20 cm / 8"
VAD305824 25 cm / 10"



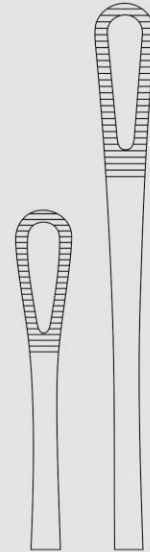
Foerster



Rampley
VAD306018 18 cm / 7"
VAD306025 25 cm / 10"



Rampley

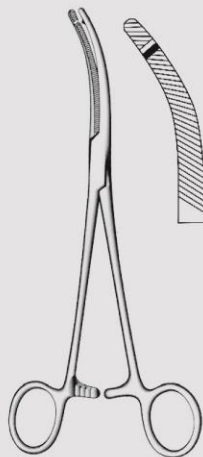


VAD306518 18 cm / 7"
VAD306524 25 cm / 10"
Box lock
VAD306618 18 cm / 7"
VAD306624 25 cm / 10"
Screw lock

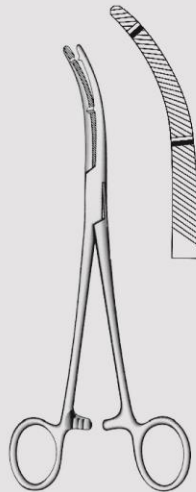


Gynecology

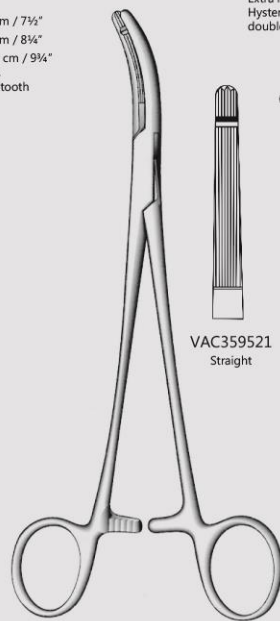
Hysterectomy & Vaginal Clamp Forceps
Hysterektomieklennen, Vaginalklennen
Pinzas-clamps para histerectomia y vaginales



Heaney
VAC358519 19 cm / 7½"
VAC358521 21 cm / 8¼"
VAC358524 24.5 cm / 9¼"
Hysterectomy forceps
Heavy pattern, single tooth
Curved



Heaney
VAC359019 19 cm / 7½"
VAC359021 21 cm / 8¼"
Heavy pattern
VAC359024 24.5 cm / 9¼"
Extra heavy pattern
Hysterectomy forceps
double tooth, curved



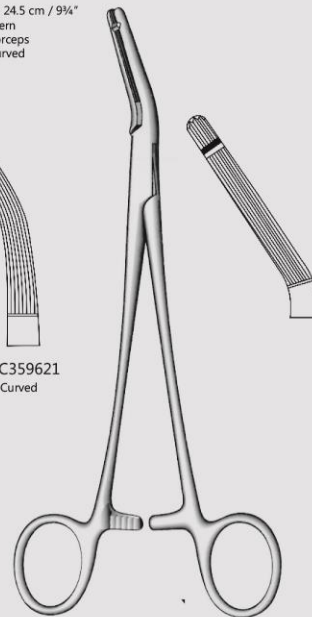
Heaney-Ballentine
21 cm / 8¼"
Longitudinal serrations, single tooth



VAC359521
Straight



VAC359621
Curved



Ballentine
VAC360021
Garland
VAC360121
21 cm / 8¼"
Longitudinal serrations,
single tooth, angled on flat

زنان و زایمان
پنس ها



SQS Certificate
ISO 9001:2000
ISO 13485:2003

673



Gynecology
Dressing Forceps, Sponge Forceps
Kornzangen, Schwammzangen
Pinzas para vendajes, Pinzas para tapones

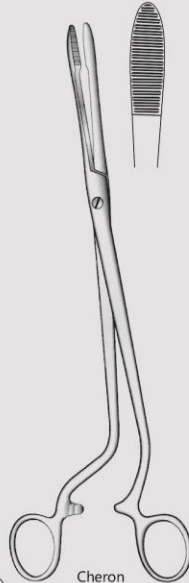
زنان و زایمان
پنس ها



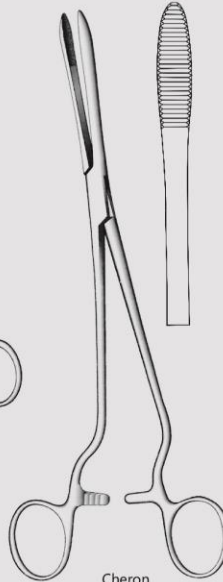
CE

SQS Certificate
ISO 9001:2000
ISO 13485:2003

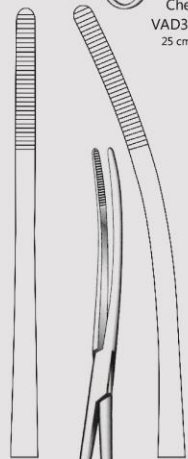
674



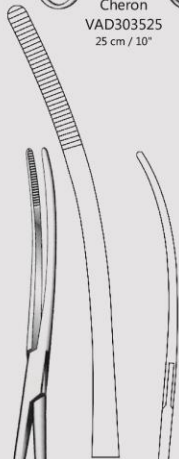
Cheron
VAD303525
25 cm / 10"



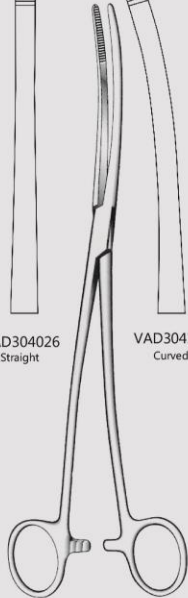
Cheron
VAD304524
24 cm / 9 1/2"
Handles laterally angled



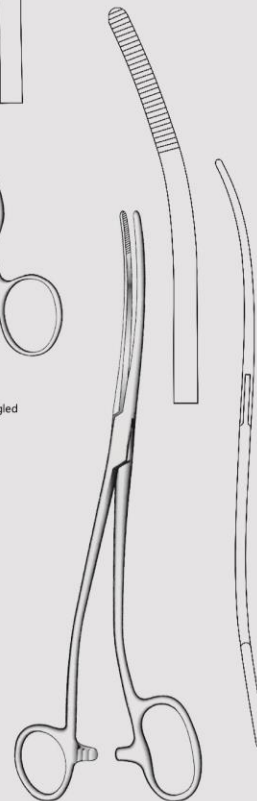
VAD304026
Straight



VAD304126
Curved



Bozemmann
26 cm / 10 1/4"



Bozemmann-Douglas
VAD305026
26 cm / 10 1/4"
One ring large



Gynecology
Uterine Elevating Forceps
Uterus-FaBzangen
Pinzas Para el Utero

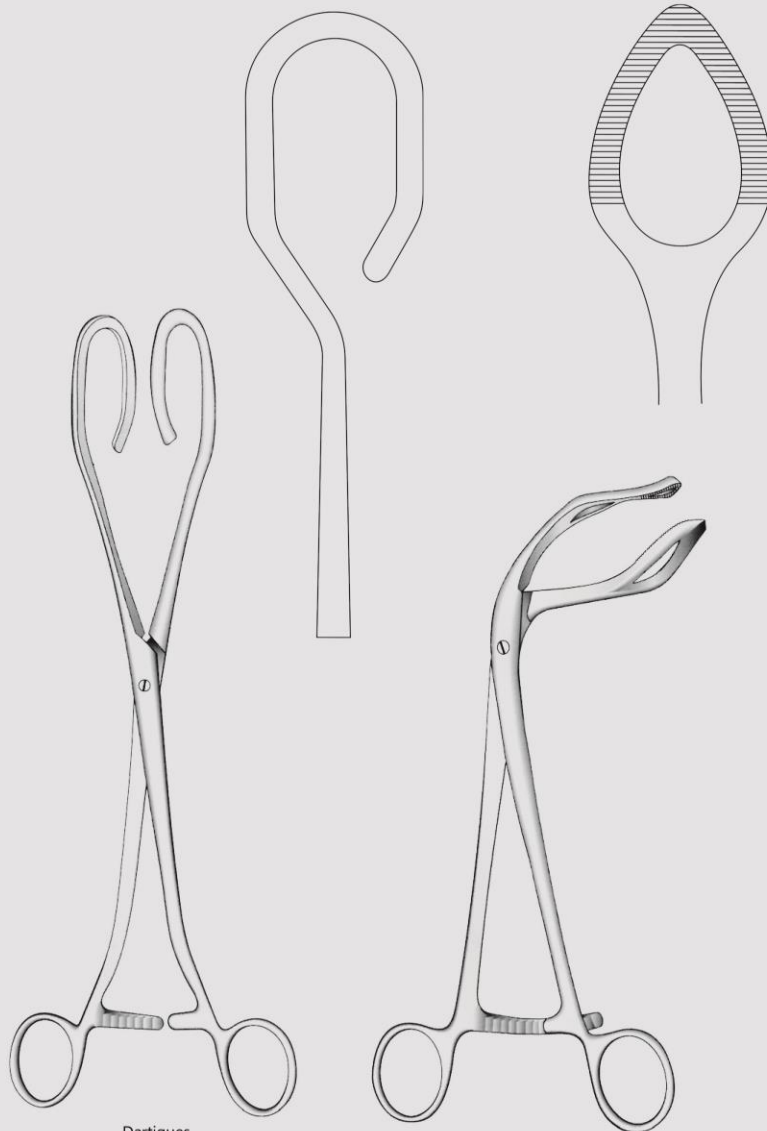
زنان و زایمان
پنس ها



CE

SQS Certificate
ISO 9001:2000
ISO 13485:2003

675



Dartigues
VCB369527
27 cm / 10 1/2"

Somer
VCB370123
23 cm / 9"



Gynecology
Uterine Elevating Forceps
Uterus-FaBzangen
Pinzas Para el Utero

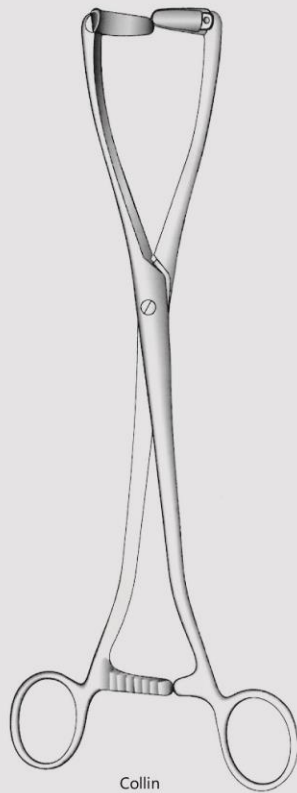
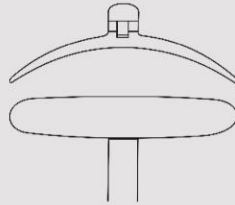
زنان و زایمان
پنس ها



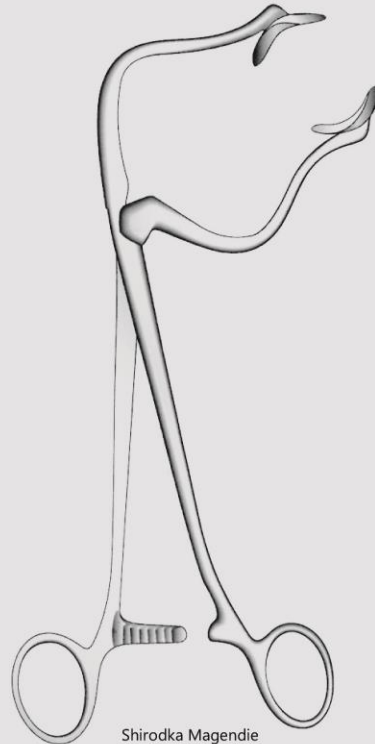
CE

SQS Certificate
ISO 9001:2000
ISO 13485:2003

676



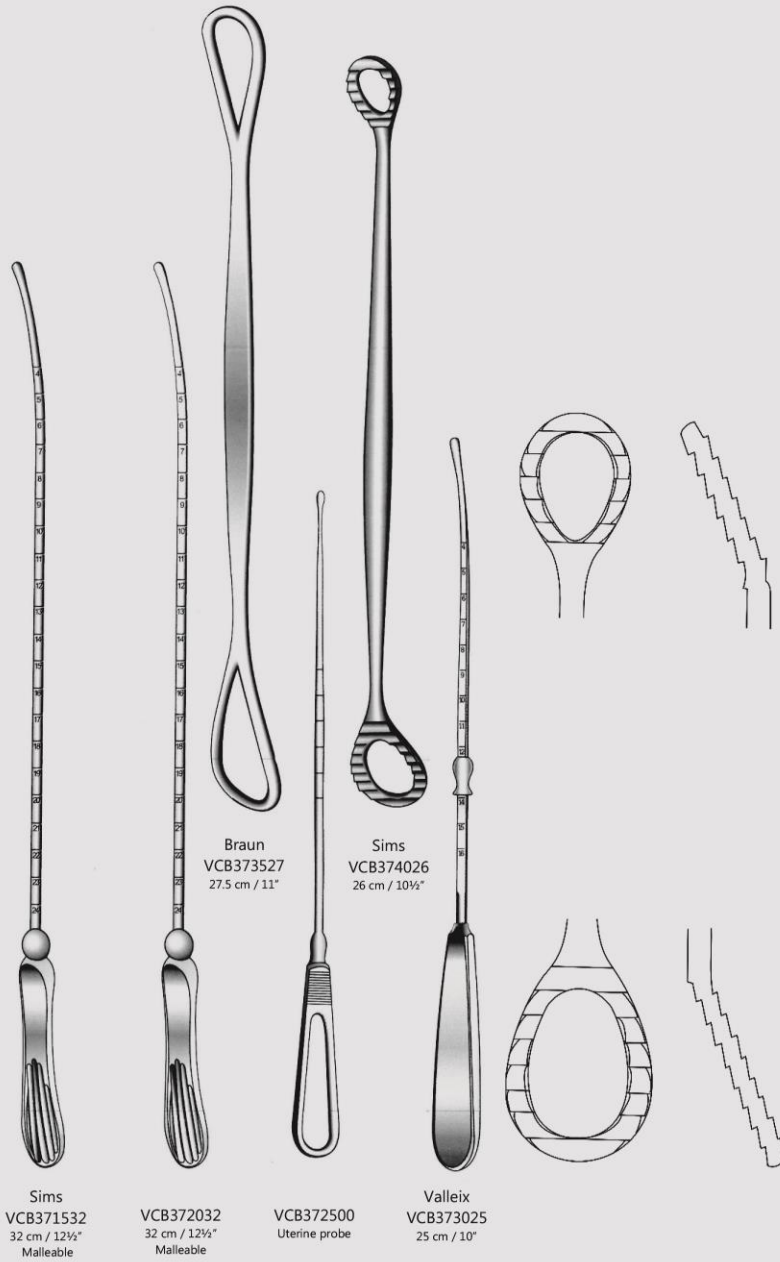
Collin
VCB370525
25 cm / 10"



Shirodka Magendie
VCB371026
26 cm / 10 1/4"



Gynecology
Uterine Sounds and Depressors
Uterussonden, Depressoren
Histerometros, Depressores Uterinos



Sims
VCB371532
32 cm / 12½"
Malleable

VCB372032
32 cm / 12½"
Malleable

VCB372500
Uterine probe

Valleix
VCB373025
25 cm / 10"

Braun
VCB373527
27.5 cm / 11"

Sims
VCB374026
26 cm / 10½"

زنان و زایمان
هیسترومتر



CE

SQS Certificate
ISO 9001:2000
ISO 13485:2003

677



Gynecology
Myoma Instruments
Myom-Instrumente
Instrumentos Para Fibroma

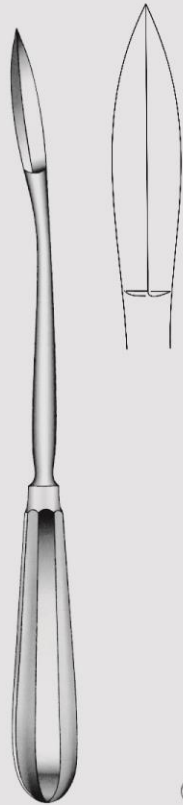
زنان و زایمان



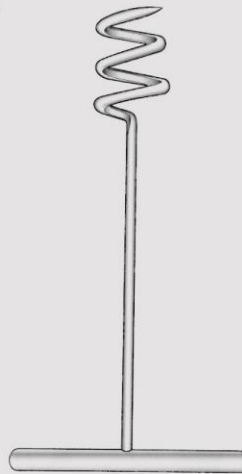
CE

SQS Certificate
ISO 9001:2000
ISO 13485:2003

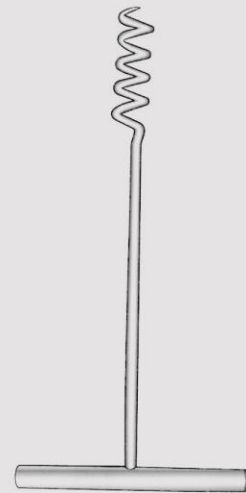
678



Segond
VCB374500
28 cm / 11"
Cutting edge 13 mm wide



Doyen
VCB375014
14 cm / 5 1/2"
Spiral



Doyen
VCB375517
17 cm / 6 3/4"
Spiral



Gynecology

Fistula Hooks, Cone Knives
Fistel Haken, Korusmesser
Ganchos P. Fistulas, Bisturip. Conos De Atracción



VCB377523
Half-curved, small
Fig. 1



VCB377623
Actual angle
Fig. 2



VCB377723
Right angle
Fig. 3



VCB377823
Half-curved, large
Fig. 4



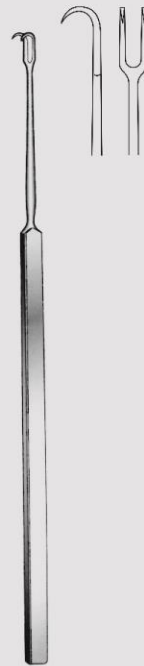
VCB377923
Double angle
Fig. 5



Ayre
VCB376023
23 cm / 9"
Conization knife
Cutting edge 6.3 mm wide



Simon
VCB376522
22 cm / 8 3/4"



Simon
VCB377022
22 cm / 8 3/4"



Emmet
Uterine tenaculum hooks
23 cm / 9"
Sharp points

زنان و زایمان
هوک ها



SQS Certificate
ISO 9001:2000
ISO 13485:2003





Gynecology

Suction Curettes, Uterine Biopsy Curettes
Saugkurretten, Biopsiekurretten
Curetas aspiradoras, Curetas para biopsia



VCB378530
Without basket



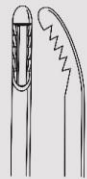
VCB378630
With basket



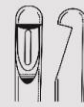
Kevorkian
30 cm / 12"



Novak
VCB379023 4 mm
VCB379123 3 mm
23 cm / 12"
With luer lock connection



Mod. Muenchen
VCB379527
27 cm / 10½"
4.8 mm^Ø



Randell
VCB380124 4 mm
VCB380224 3 mm
24 cm / 9½"



زنان و زایمان
کورت ها

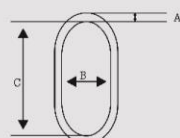


SQS Certificate
ISO 9001:2000
ISO 13485:2003



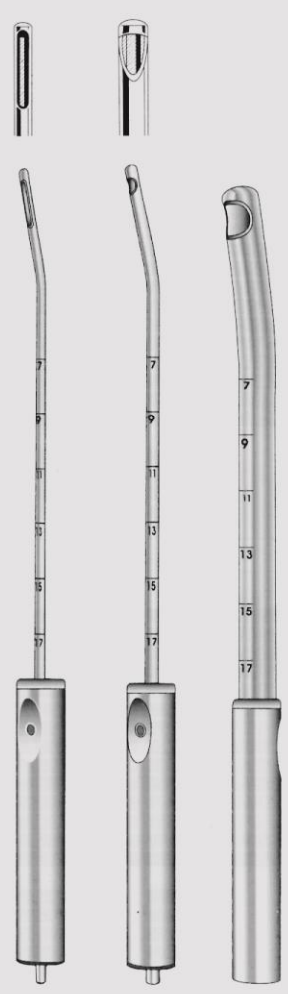


Gynecology
Aspirating Curettes
Absangkuretten
Curetas De Aspiracion



		A	B	C
VCB381000	5 mm	1 mm	4.0 mm	9 mm
VCB381100	6 mm	1 mm	5.0 mm	10 mm
VCB381200	7 mm	1 mm	5.5 mm	11 mm
VCB381300	8 mm	1 mm	6.0 mm	12 mm
VCB381400	9 mm	1 mm	6.5 mm	13 mm
VCB381500	10 mm	2 mm	7.5 mm	14 mm
VCB381600	12 mm	2 mm	10 mm	14 mm
VCB381700	14 mm	2 mm	11 mm	16.5 mm

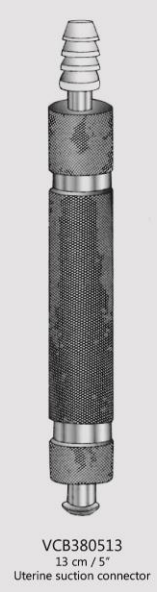
Uterine suction tube



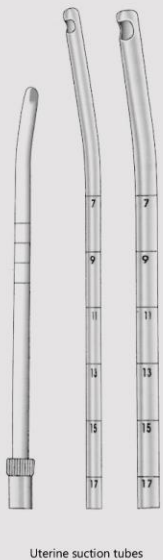
VCB383000 6 mm
VCB383100 8 mm

VCB383200 10 mm
VCB383300 12 mm

VCB383400 14 mm



VCB380513
13 cm / 5"
Uterine suction connector



Uterine suction tubes

VCB382000
29 cm / 11½"
3 mm
Specimen & aspirating curette

VCB382500
29 cm / 11½"
4.5 mm
Specimen & aspirating curette

Aspirating curettes
29 cm / 11½"



VCB384000
12 cm / 4¼"
Coupling piece

زنان و زایمان
کورت ها



SQS Certificate
ISO 9001:2000
ISO 13485:2003





Gynecology
Uterine Curettes
Uteruskuretten
Curetas Uterinas

زنان و زایمان
کورت ها

ایر جراحی
دایموند

CE

SQS Certificate
ISO 9001:2000
ISO 13485:2003

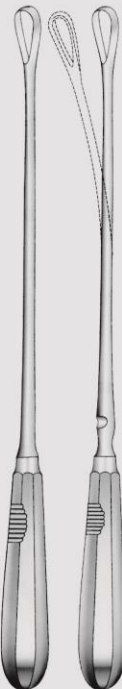
682



Rigid curettes
(Plain shaft)



Malleable curettes
(Grooved shaft)



Recamier-Sims-Bumm
Sharp blades

Sharp blades					
Rigid		Malleable		Fig.	Size mm
26 cm	31 cm	26 cm	31 cm		
VCB384526	VCB386531	VCB388526	VCB390531	00	5
VCB384626	VCB386631	VCB388626	VCB390631	0	6
VCB384726	VCB386731	VCB388726	VCB390731	1	7
VCB384826	VCB386831	VCB388826	VCB390831	2	8
VCB384926	VCB386931	VCB388926	VCB390931	3	9
VCB385026	VCB387031	VCB389026	VCB391031	4	11
VCB385126	VCB387131	VCB389126	VCB391131	5	12
VCB385226	VCB387231	VCB389226	VCB391231	6	14
VCB385326	VCB387331	VCB389326	VCB391331	7	15
VCB385426	VCB387431	VCB389426	VCB391431	8	16
VCB385526	VCB387531	VCB389526	VCB391531	9	19
VCB385626	VCB387631	VCB389626	VCB391631	10	20
VCB385726	VCB387731	VCB389726	VCB391731	11	21
VCB385826	VCB387831	VCB389826	VCB391831	12	23
VCB385926	VCB387931	VCB389926	VCB391931	13	25
VCB386026	VCB388031	VCB390026	VCB392031	14	30
VCB386126	VCB388131	VCB390126	VCB392131	15	35
VCB386226	VCB388231	VCB390226	VCB392231	16	40

Blunt blades					
Rigid		Malleable		Fig.	Size mm
26 cm	31 cm	26 cm	31 cm		
VCB392526	VCB394531	VCB396526	VCB398531	00	5
VCB392626	VCB394631	VCB396626	VCB398631	0	6
VCB392726	VCB394731	VCB396726	VCB398731	1	7
VCB392826	VCB394831	VCB396826	VCB398831	2	8
VCB392926	VCB394931	VCB396926	VCB398931	3	9
VCB393026	VCB395031	VCB397026	VCB399031	4	11
VCB393126	VCB395131	VCB397126	VCB399131	5	12
VCB393226	VCB395231	VCB397226	VCB399231	6	14
VCB393326	VCB395331	VCB397326	VCB399331	7	15
VCB393426	VCB395431	VCB397426	VCB399431	8	16
VCB393526	VCB395531	VCB397526	VCB399531	9	19
VCB393626	VCB395631	VCB397626	VCB399631	10	20
VCB393726	VCB395731	VCB397726	VCB399731	11	21
VCB393826	VCB395831	VCB397826	VCB399831	12	23
VCB393926	VCB395931	VCB397926	VCB399931	13	25
VCB394026	VCB396031	VCB398026	VCB400031	14	30
VCB394126	VCB396131	VCB398126	VCB400131	15	35
VCB394226	VCB396231	VCB398226	VCB400231	16	40



Recamier-Sims-Bumm
Blunt blades



Gynecology
Uterine Curettes
Uteruskurretten
Curetas Uterinas



زنان و زایمان
کورت ها



CE

SQS Certificate
ISO 9001:2000
ISO 13485:2003





Gynecology
Uterine Curettes
Uteruskuretten
Curetas Uterinas

زنان و زایمان
کورت ها



CE

SQS Certificate
ISO 9001:2000
ISO 13485:2003

684

Not illustrated

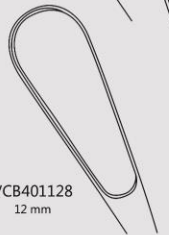
Mayo Blake
VCB400500
Curette, double ended



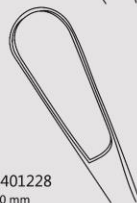
Sims
28 cm / 11"
Sharp, malleable



VCB401028
15 mm



VCB401128
12 mm



VCB401228
10 mm



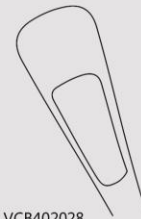
VCB401328
7 mm



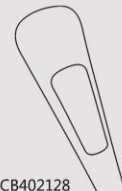
VCB401428
4 mm



J.O.M.W Type
28 cm / 11"
Uterine curettes



VCB402028
15 mm



VCB402128
12 mm



VCB402228
9 mm



VCB402328
7.5 mm



VCB402428
6 mm



VCB402528
4.5 mm



Gynecology
 Uterine Scoops
 Uterusloffel
 Cucharillas Y Curetas Uterinas

	VCB403030 9.8 x 6.8 mm	VCB403130 11.6 x 8.3 mm	VCB403230 13.2 x 10.0 mm	VCB404025 9.8 x 6.8 mm	VCB404125 11.6 x 8.3 mm	VCB404225 13.2 x 10.0 mm
	VCB403330 16.0 x 11.6 mm	VCB403430 18.0 x 12.6 mm	VCB403530 20.0 x 13.8 mm	VCB404325 16.0 x 11.6 mm	VCB404425 18.0 x 12.6 mm	VCB404525 20.0 x 13.8 mm
Schroeder 30 cm / 12" Sharp, rigid				Simon 25 cm / 10" Sharp, rigid		

زنان و زایمان
 کورت ها



CE

SQS Certificate
 ISO 9001:2000
 ISO 13485:2003





Gynecology
Uterine Biopsy Forceps
Probeexzisionszangen
Pinzas Para Biopsia

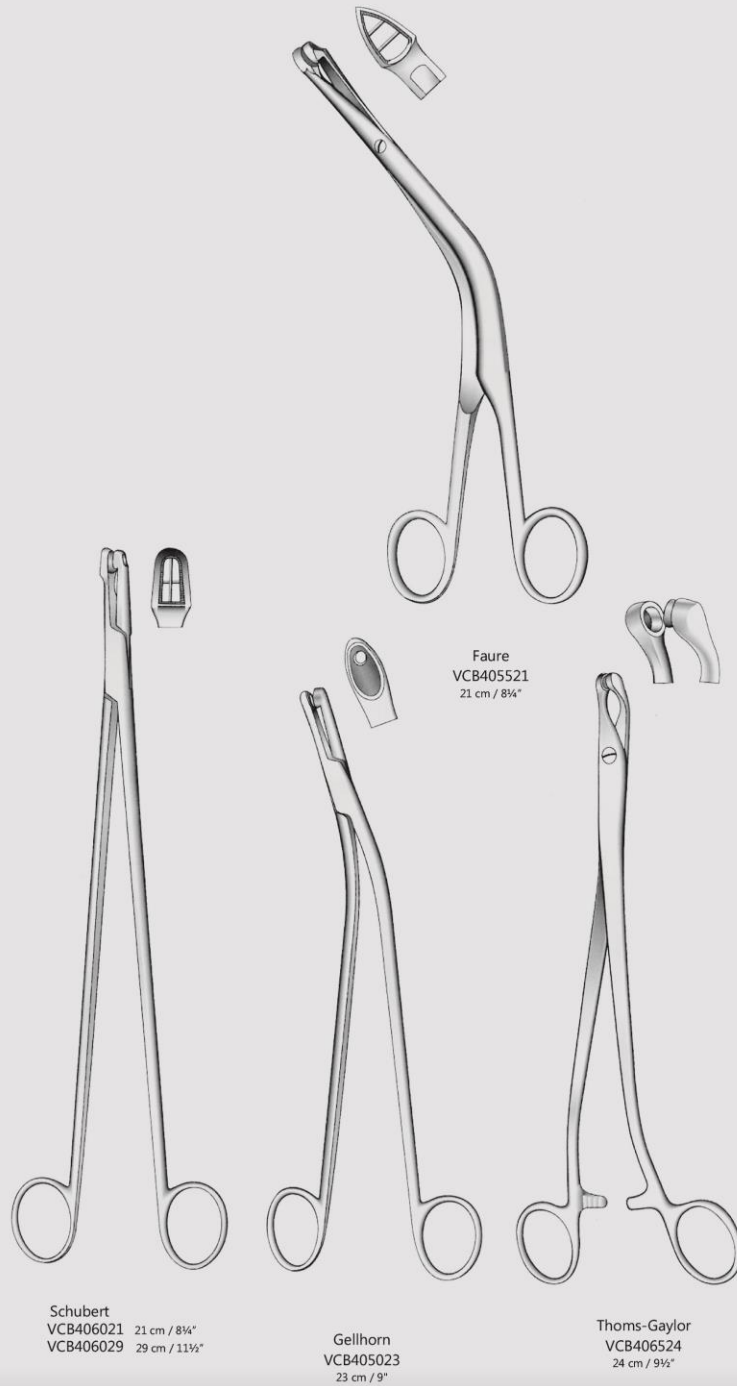
زنان و زایمان
پانچ ها



CE

SQS Certificate
ISO 9001:2000
ISO 13485:2003

686



Schubert
VCB406021 21 cm / 8¼"
VCB406029 29 cm / 11½"

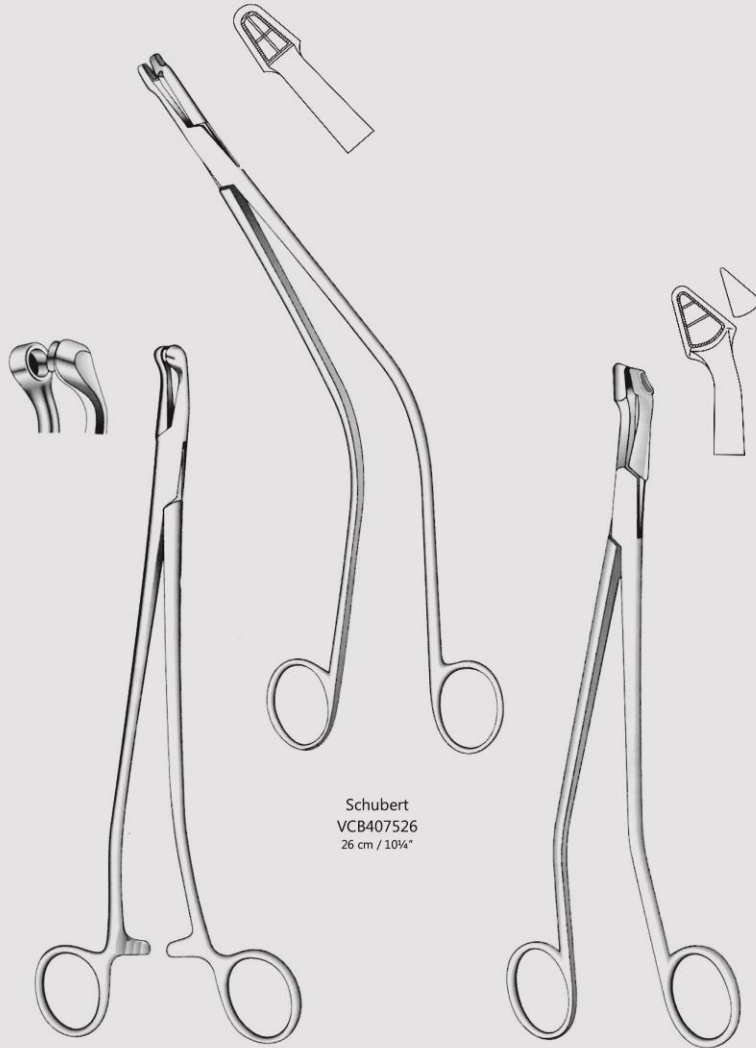
Gellhorn
VCB405023
23 cm / 9"

Faure
VCB405521
21 cm / 8¼"

Thoms-Gaylor
VCB406524
24 cm / 9½"



Gynecology
Uterine Biopsy Forceps
Probexzisionszangen
Pinzas Para Biopsia



Thoms-Gaylor
VCB407022 22 cm / 8½"
VCB407024 24 cm / 9½"

Schubert
VCB407526
26 cm / 10¼"

Van-Doren
VCB408024
24 cm / 9½"

زنان و زایمان
پانچ ها



CE

SQS Certificate
ISO 9001:2000
ISO 13485:2003

687



Gynecology
 Uterine Biopsy Forceps
 Probeexzisionszangen
 Pinzas Para Biopsia

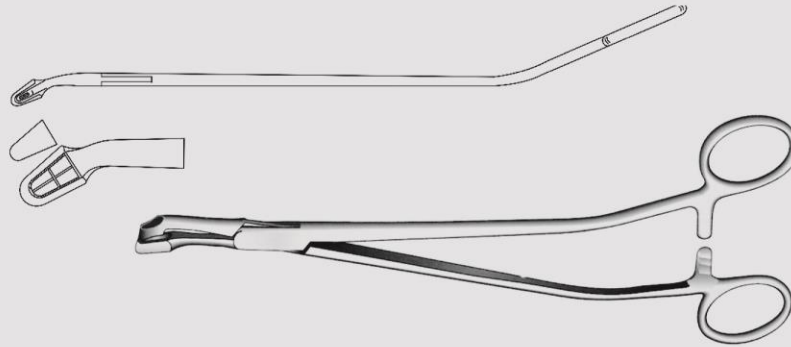
زنان و زایمان
 پانچ‌ها



CE

SQS Certificate
 ISO 9001:2000
 ISO 13485:2003

688

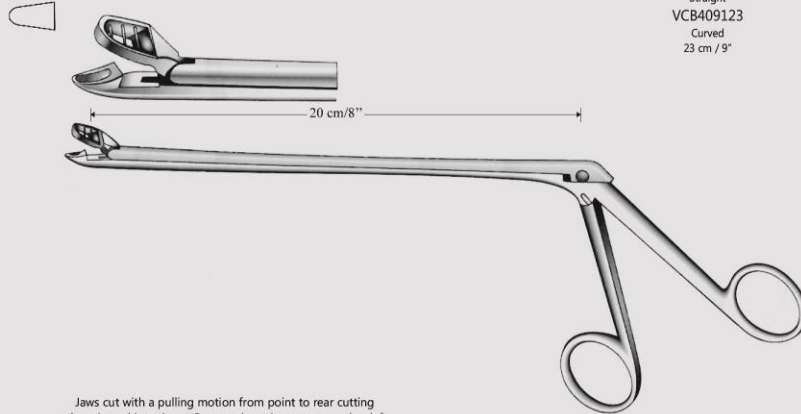


Van-Doren
 VCB408525
 25 cm / 10"



4 x 8 mm

Wittner
 VCB409023
 Straight
 VCB409123
 Curved
 23 cm / 9"

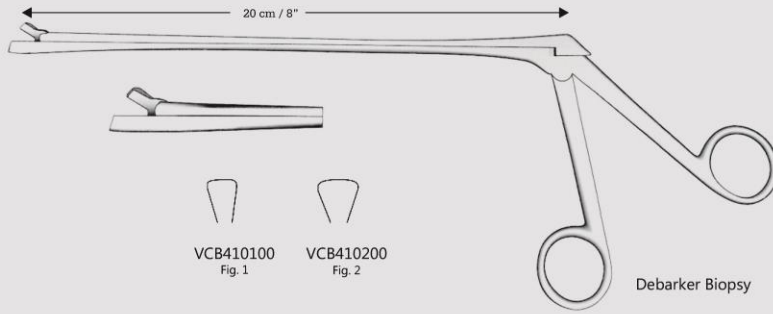


Jaws cut with a pulling motion from point to rear cutting edge planted into tissue. Better view as jaws are curved to left. Can be used in colposcopy

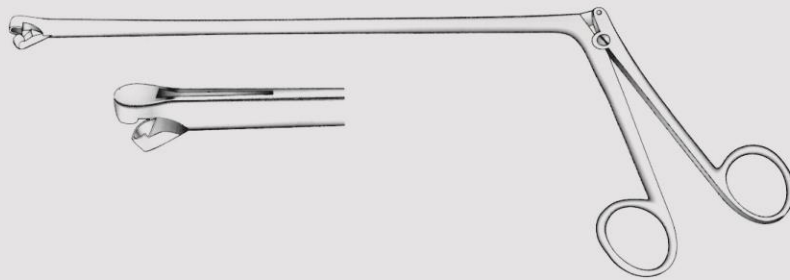
Alexander
 VCB409528
 28 cm / 11"



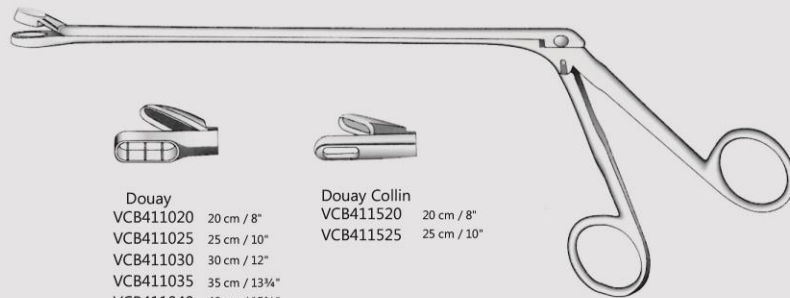
Gynecology
Cervical Biopsy and Specimen Forceps
Probexizisionszangen
Pinzas Saca-Bocados Para Biopsia



Debarker Biopsy



Berger
VCB410521
21 cm / 8 3/4"



Douay
VCB411020 20 cm / 8"
VCB411025 25 cm / 10"
VCB411030 30 cm / 12"
VCB411035 35 cm / 13 3/4"
VCB411040 40 cm / 15 1/4"

Douay Collin
VCB411520 20 cm / 8"
VCB411525 25 cm / 10"

زنان و زایمان
پانچ ها



CE

SQS Certificate
ISO 9001:2000
ISO 13485:2003

689

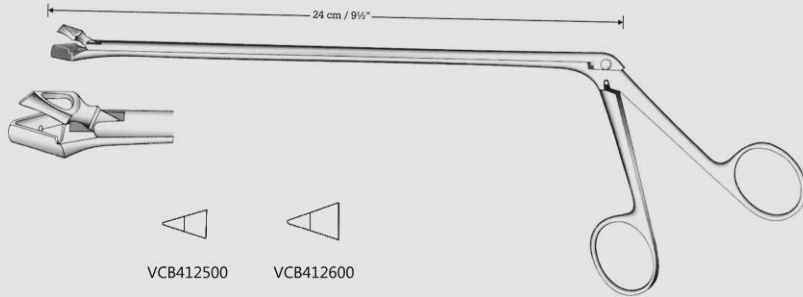


Gynecology
 Uterine Biopsy Forceps
 Probeexzisionszangen
 Pinzas Para Biopsia

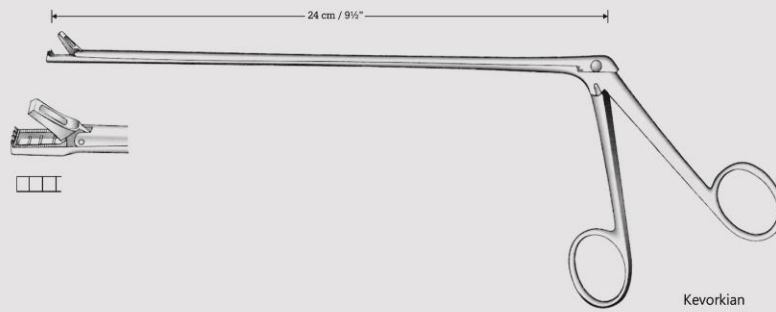
زنان و زایمان
 پانچ‌ها



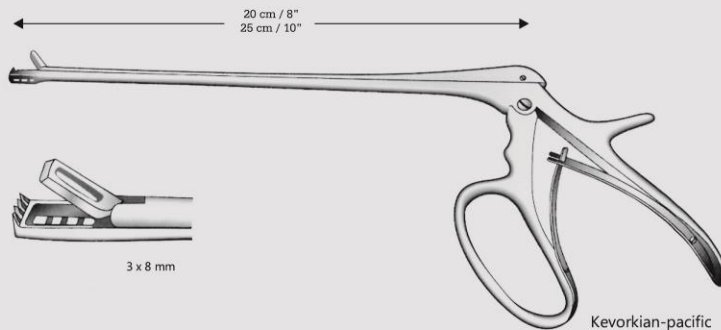
CE
 SQS Certificate
 ISO 9001:2000
 ISO 13485:2003



Schumacher



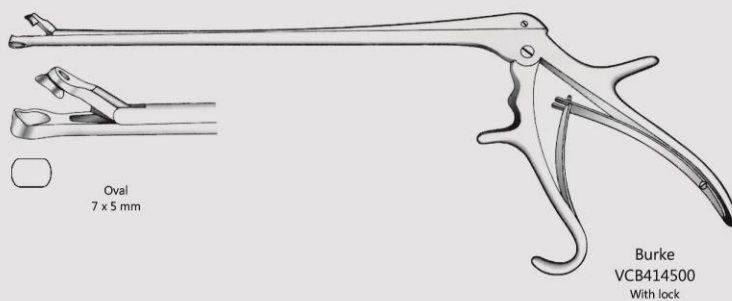
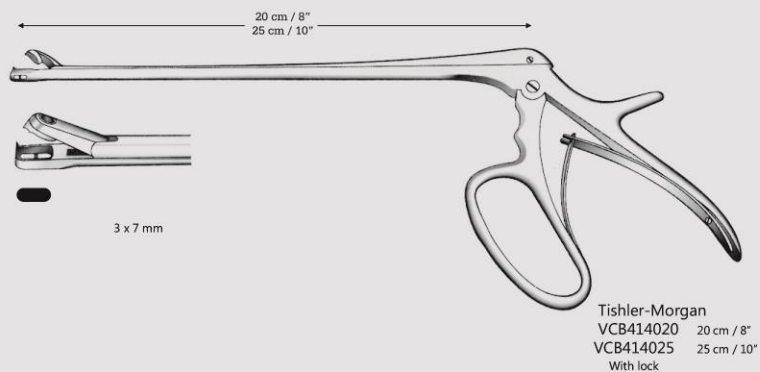
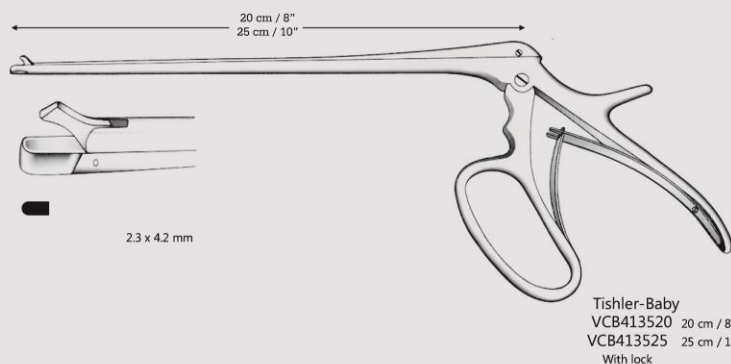
Kevorkian
 VCB412000



Kevorkian-Pacific
 VCB413020 20 cm / 8"
 VCB413025 25 cm / 10"
 With lock



Gynecology
Cervical Biopsy and Specimen Forceps
Probeeziionszangen
Pinzas Saca-Bocados Para Biopsia



زنان و زایمان
پانچ‌ها



CE

SQS Certificate
ISO 9001:2000
ISO 13485:2003

691



Gynecology
 Uterine Biopsy Forceps
 Probeexzisionszangen
 Pinzas Para Biopsia

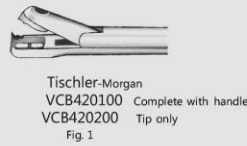
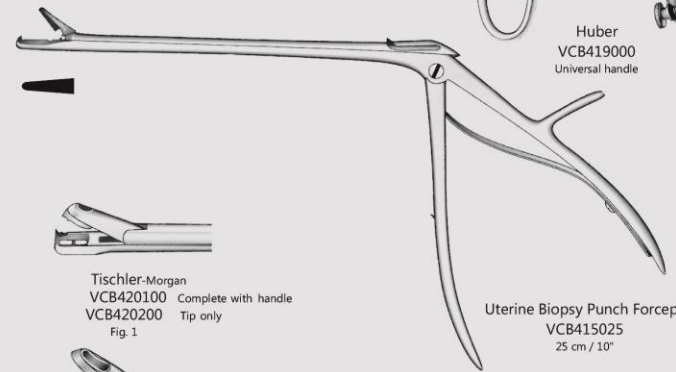
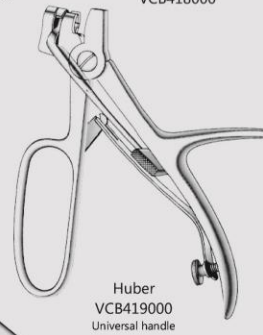
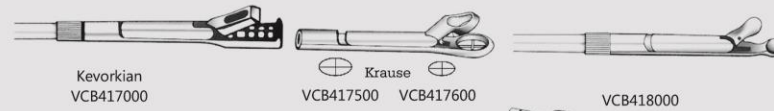
زنان و زایمان
 پانچ‌ها



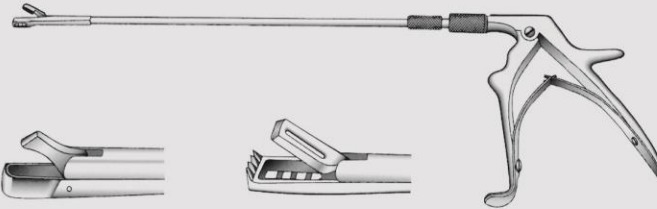
CE

SQS Certificate
 ISO 9001:2000
 ISO 13485:2003

692



VCB420500 Complete with handle
 VCB420600 Tip only
 Fig. 3



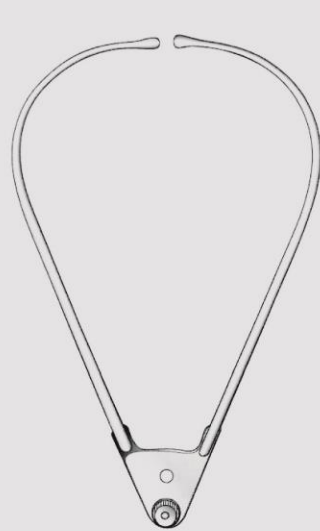
VCB421000 Complete with handle
 VCB421100 Tip only
 mini
 Fig. 5

Kevorkian
 VCB421500 Complete with handle
 VCB421600 Tip only
 Fig. 4

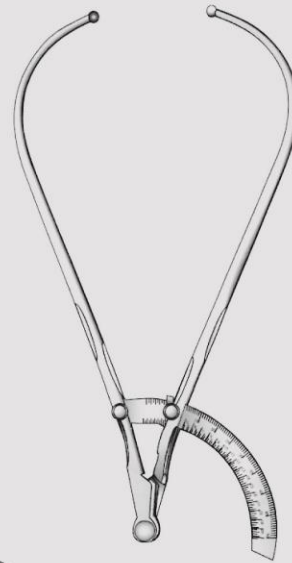
Townsend
 VCB419500
 Handle only



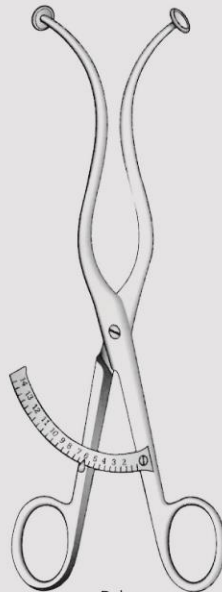
Gynecology
Pelvimeters
Beckenzirkel
Pelvimetros



Collyer
VCB422030
30 cm / 12"



VCB422534
34 cm / 13 1/2"
Graduated in centimeters.



Delee
VCB423000
For interior measurements
between symphysis and
promontory

زنان و زایمان



CE

SQS Certificate
ISO 9001:2000
ISO 13485:2003

693



Gynecology
Pelvimeters
Beckenzirkel
Pelvimetros

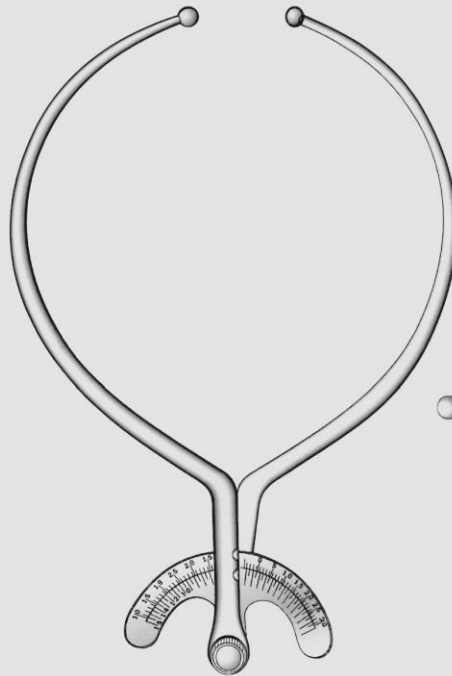
زنان و زایمان



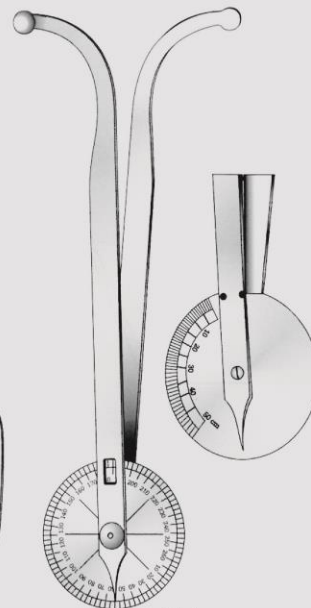
CE

SQS Certificate
ISO 9001:2000
ISO 13485:2003

694



Breisky
VCB423533
33 cm / 13"
Graduated in centimeters.



Thole
VAG308534
34 cm / 13½"
Goniometer, graduated in centimeters.
For internal & external measurements.



Collin
VCB424535
35 cm / 13¾"
Graduated in centimeters.



Gynecology
Obstetrical(Midwifery) Forceps
Geburtszangen
Forceps Obstericos



Kielland
VCB425042
42 cm / 16 1/4"

Nagele
VCB425540
40 cm / 16"

Nagele
VCB426035
35.5 cm / 14 1/8"

زنان و زایمان
پنس ها



CE

SQS Certificate
ISO 9001:2000
ISO 13485:2003

695



Gynecology
Obstetrical (Midwifery) Forceps
Geburtszangen
Forceps Obstetricos

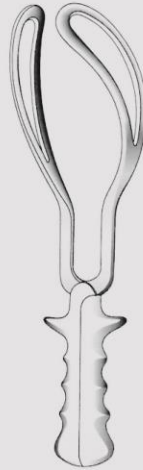
زنان و زایمان
پنس ها



CE

SQS Certificate
ISO 9001:2000
ISO 13485:2003

696



Simpson-Braun
VCB426530
30.5 cm / 12"
VCB426535
35 cm / 14"

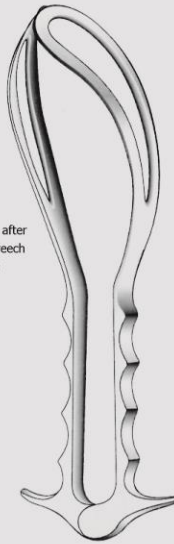


Simpson-Braun
VCB427035
35 cm / 14"
VCB427030
30.5 cm / 12"



Piper
VCB427544
44.5 cm / 17½"

For delivery of the after
coming head in breech
presentation



Boerma
VCB428028
28 cm / 11"
For caesarean section



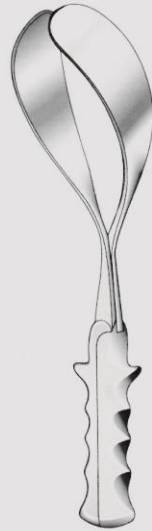
Simpson
VCB428523
23.5 cm / 9¼"
For caesatean section



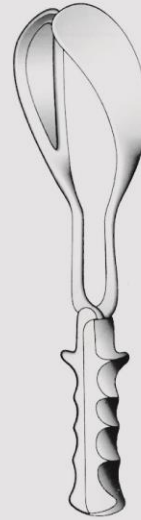
Gynecology
Obstetrical(Midwifery) Forceps
Geburtszangen
Forceps Obstericos



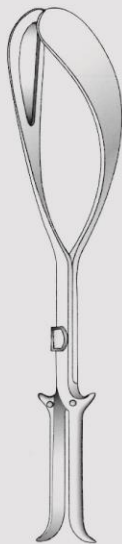
Wrigley
VCB429025
25 cm / 10"
For caesatean section



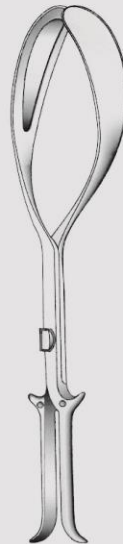
Mclean
VCB429539
39.5 cm / 15½"
Solid blades, short shanks



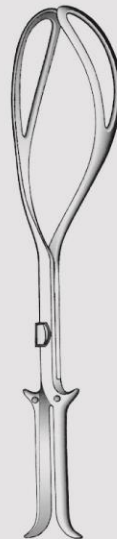
Simpsons-Luikart
VCB430138
38 cm / 15"
Solid blades



Luikart
VCB430539
39.5 cm / 15½"
Solid blades



Kielland-Luikart
VCB431039
39.5 cm / 15½"
Solid blades



Kielland
VCB431539
39.5 cm / 15½"

زنان و زایمان
پنس ها



CE

SQS Certificate
ISO 9001:2000
ISO 13485:2003

697



Gynecology
Obstetrical (Midwifery) Forceps
Geburtszangen
Forceps Obstetricos

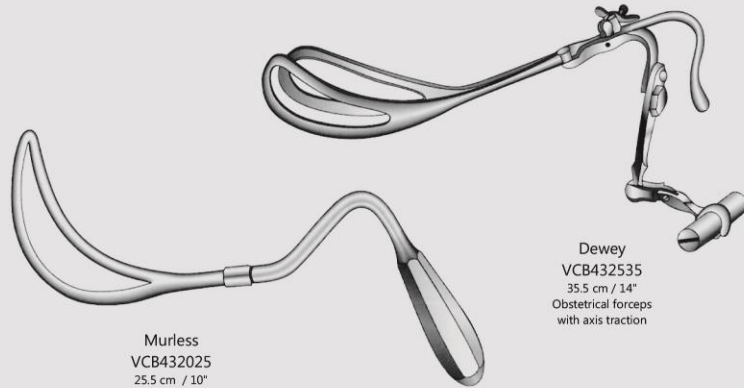
زنان و زایمان
پنس ها



CE

SQS Certificate
ISO 9001:2000
ISO 13485:2003

698



Murless
VCB432025
25.5 cm / 10"
Head extractor
with hinged shaft and sliding collar lock

Dewey
VCB432535
35.5 cm / 14"
Obstetrical forceps
with axis traction



Barton
VCB434035
35.5 cm / 14"
One hinged blade

Hawks-Dennen
VCB433538
38 cm / 15"

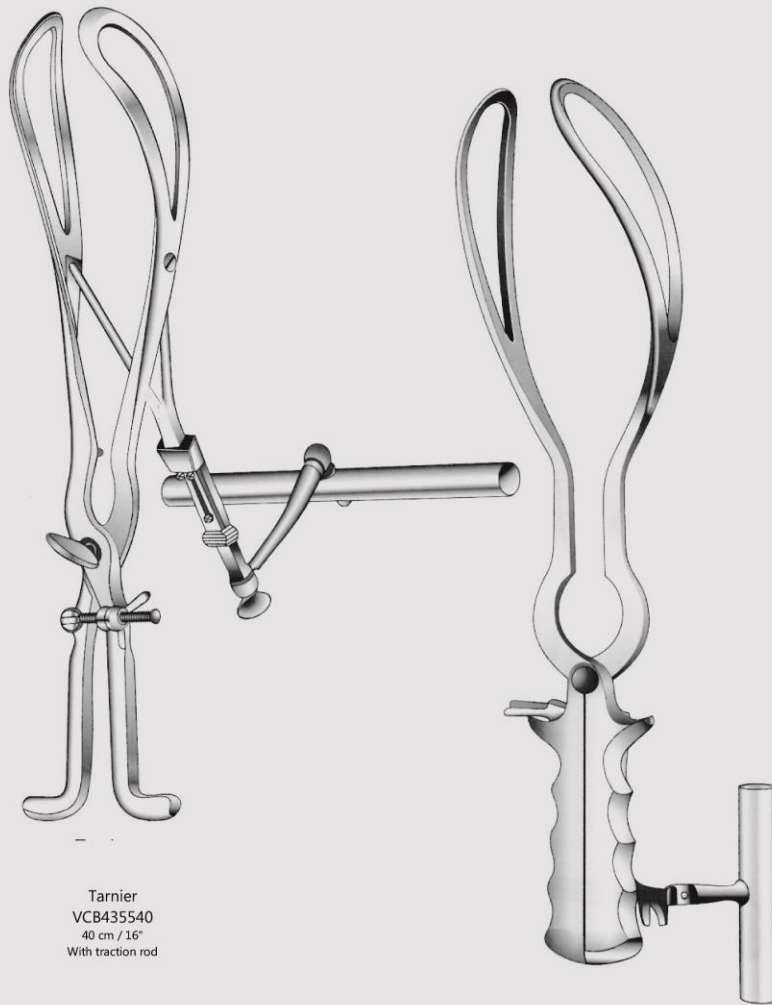
Mclean-Tucker-Luikart
VCB435040
40 cm / 15 1/4"
Solid blades, long shanks

Bailey-Williamson
VCB433039
39.5 cm / 15 1/2"

Mclean-Luikart
VCB434540
40 cm / 15 1/4"
Solid blades, long shanks



Gynecology
Obstetrical(Midwifery) Forceps
Geburtszangen
Forceps Obstericos



Tarnier
VCB435540
40 cm / 16"
With traction rod

Barnes-Neville
VCB436043
43.5 cm / 17"
With traction handle

زنان و زایمان
پنس ها



CE

SQS Certificate
ISO 9001:2000
ISO 13485:2003

699



Gynecology
Obstetrical (Midwifery) Forceps
Geburtszangen
Forceps Obstetricos

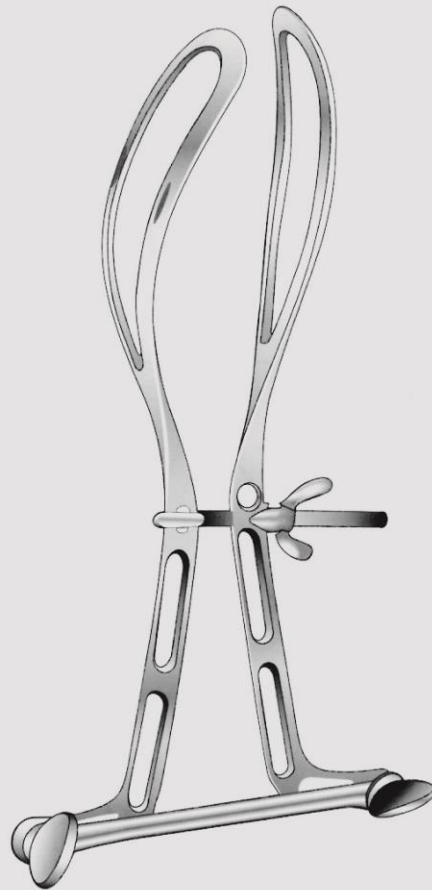
زنان و زایمان
پنس ها



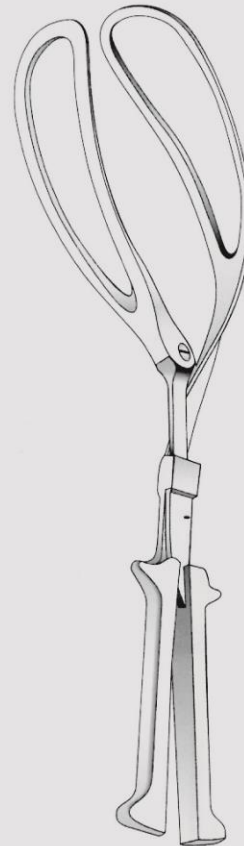
CE

SQS Certificate
ISO 9001:2000
ISO 13485:2003

700



Barton
VCB436536
36 cm / 14 $\frac{1}{4}$ "



Demelin Suzor
VCB437032
32 cm / 12 $\frac{1}{4}$ "

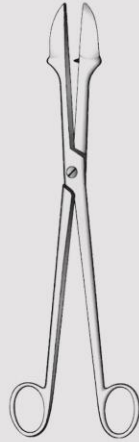


Gynecology

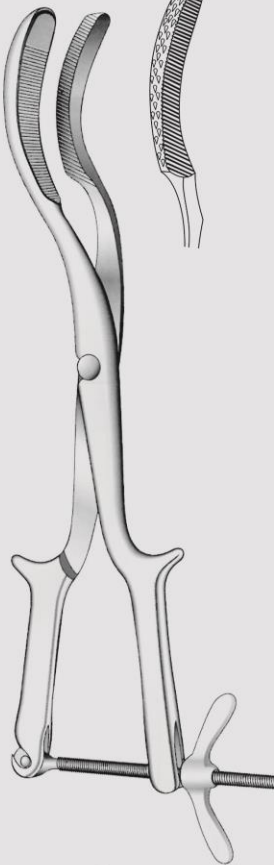
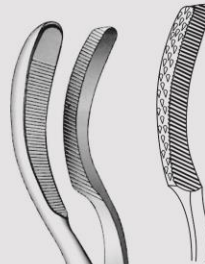
Osteotric-Perforator, Cranioclast, Basiotribe
Geburtshilfe-Perforatorium, Kranioclast, Basiotrib
Ostetricia



Naegele
VCB438525
25 cm / 10"



Smellie
VCB439027
27 cm / 10 1/4"
Perforator



Braun
VCB438042
42 cm / 16 1/2"
Cranioclast



Tamier
VCB437544
44 cm / 17 1/2"
Basiotribe

زنان و زایمان
پنس ها



CE

SQS Certificate
ISO 9001:2000
ISO 13485:2003

701



Gynecology
Placenta and Ovum Forceps
Abortuszangen
Pinzas para aborto

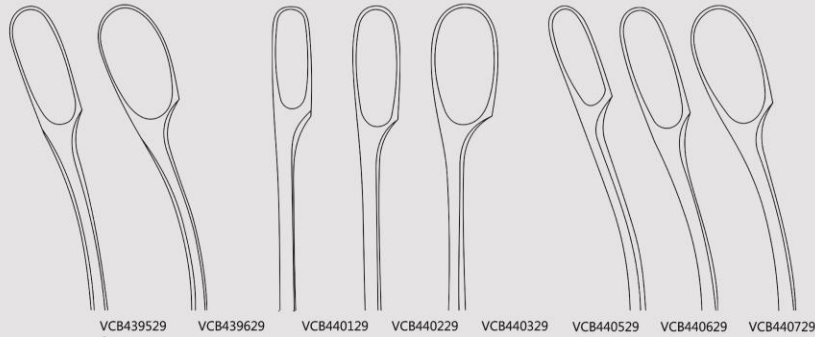
زنان و زایمان
پنس ها



CE

SQS Certificate
ISO 9001:2000
ISO 13485:2003

702



VCB439529

VCB439629

VCB440129

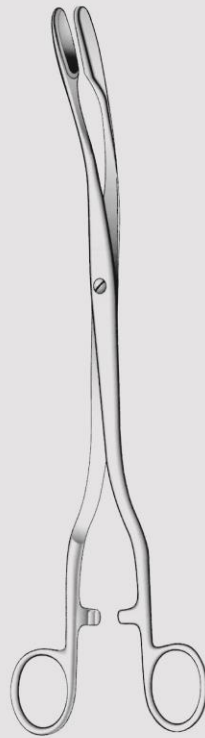
VCB440229

VCB440329

VCB440529

VCB440629

VCB440729



Winter
29 cm / 11½"



Winter
29 cm / 11½"

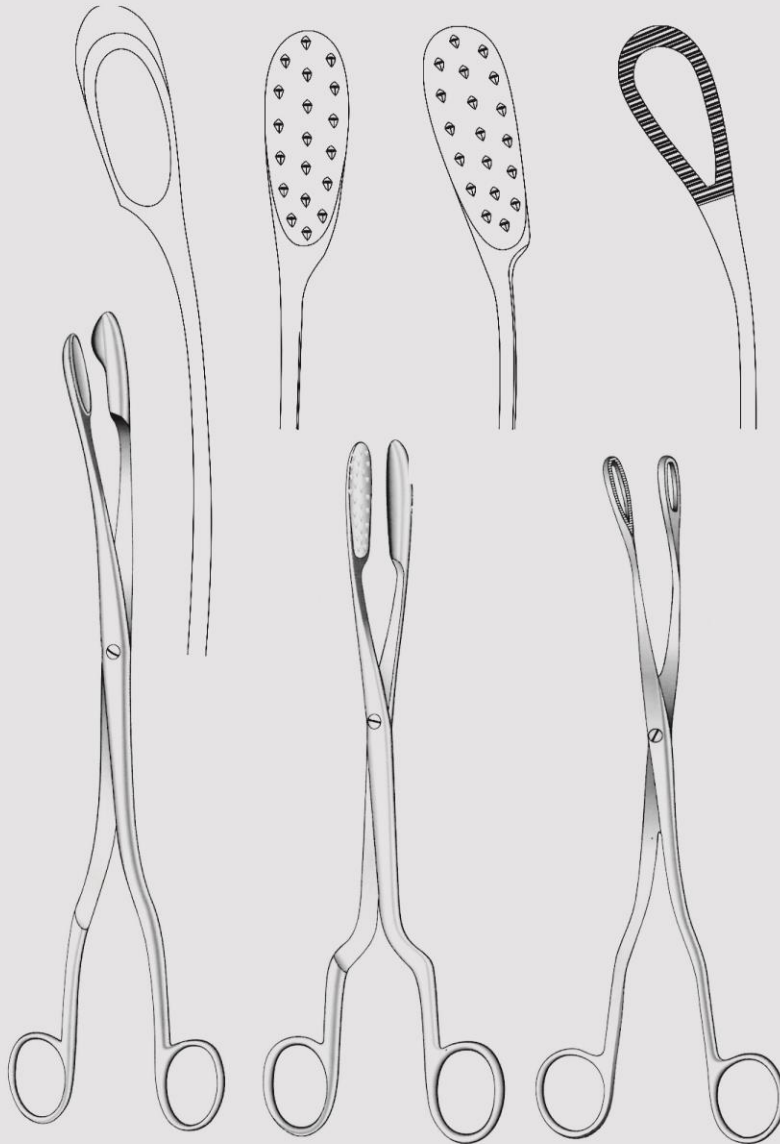


Winter
29 cm / 11½"

www.Diamondmed.ir



Gynecology
Placenta and Ovum Forceps
Abortuszangen
Pinzas para aborto



VCB441028
28.5 cm / 11 1/4"
With protecting cap

Lewkowitz
VCB441524
24.5 cm / 9 3/4"

Mc clintock
VCB442024
24 cm / 9 1/2"

زنان و زایمان
پنس ها



CE

SQS Certificate
ISO 9001:2000
ISO 13485:2003

703



Gynecology
Placenta and Ovum Forceps
Abortuszangen
Pinzas para aborto

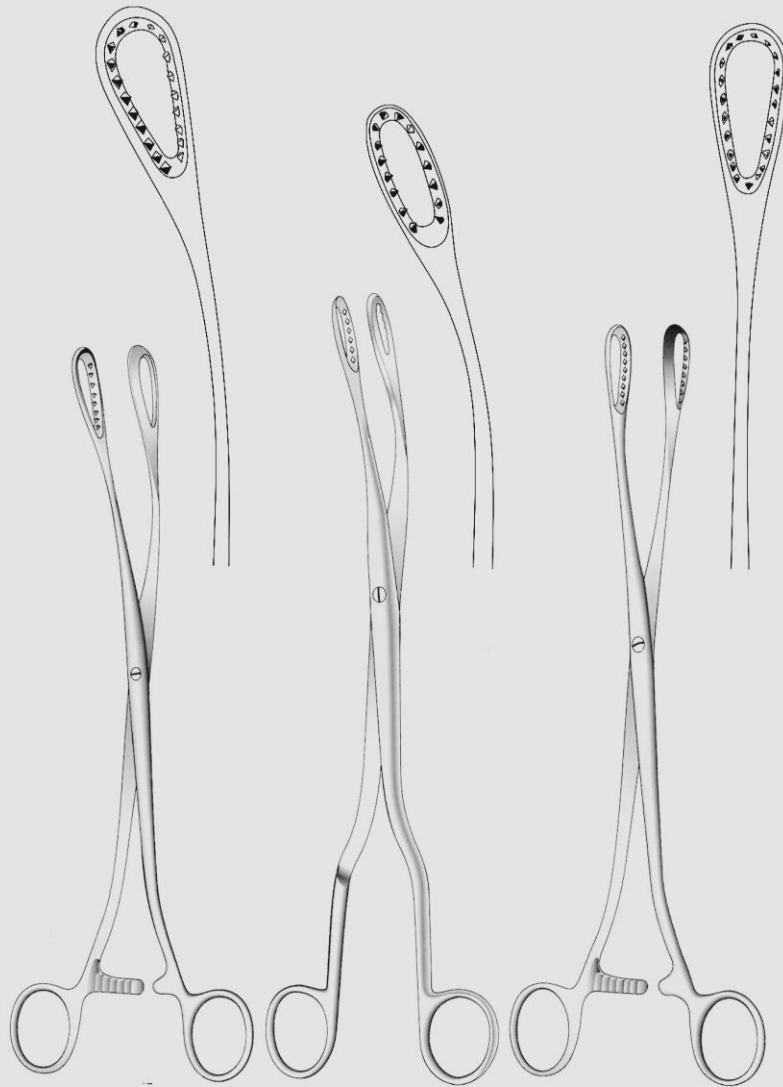
زنان و زایمان
پنس ها



CE

SQS Certificate
ISO 9001:2000
ISO 13485:2003

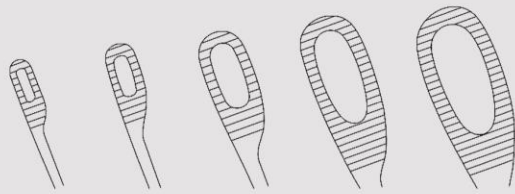
704



Saenger
VCB442526
26.5 cm / 10 1/2"

Saenger
VCB443028
28.5 cm / 11 1/4"

Saenger
VCB443527
27.5 cm / 10 3/4"



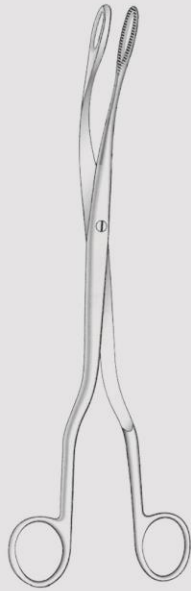
VCB444025
Fig. 1

VCB444125
Fig. 2

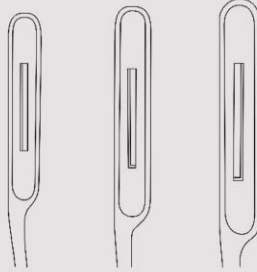
VCB444225
Fig. 3

VCB444325
Fig. 4

VCB444425
Fig. 5



Placenta forceps
25 cm / 10"



VCB445027
Small
Fig. 1

VCB445127
Medium
Fig. 2

VCB445227
Large
Fig. 3



Hirst
27.5 cm / 10 7/8"
Placenta forceps



Gynecology
Obstetrical Forceps
Geburtszangen
Forceps obstetricos

زنان و زایمان
پنس ها



CE

SQS Certificate
ISO 9001:2000
ISO 13485:2003





Gynecology

Obstetrical Forceps, Hook & Scissors
Geburtszangen, Haken und Scheren
Forceps Obstetricos, Gancho Y Tijeras

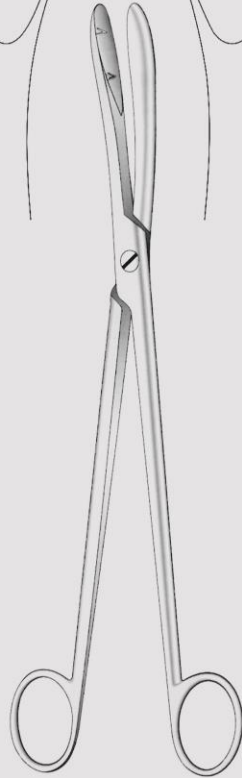
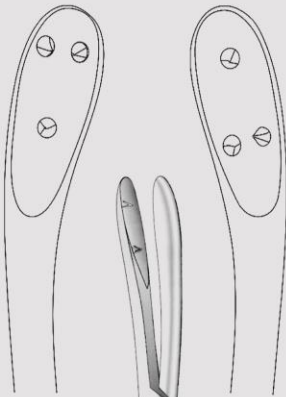
زنان و زایمان
پنس، هوک، قیچی



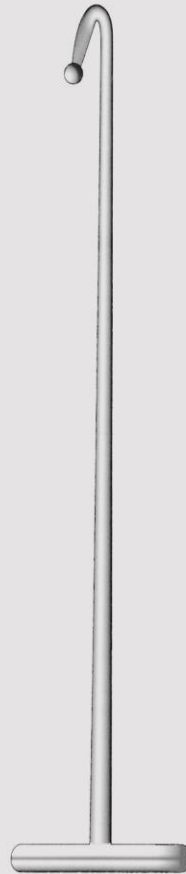
CE

SQS Certificate
ISO 9001:2000
ISO 13485:2003

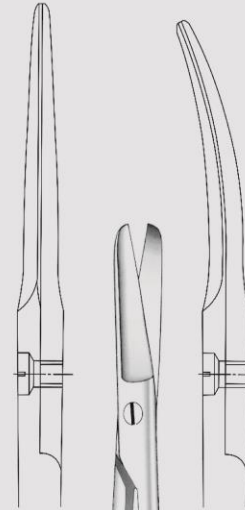
706



Boer
VCB445529
29 cm / 11½"
Craniotomy forceps

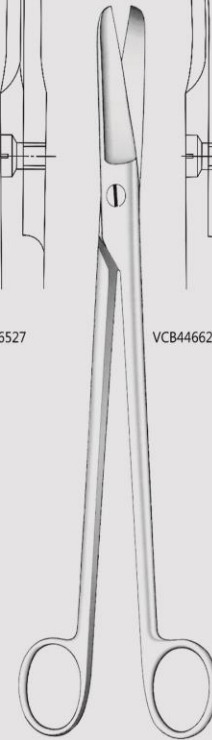


Braun
VCB446032
32.5 cm / 13"
Decapitating hook

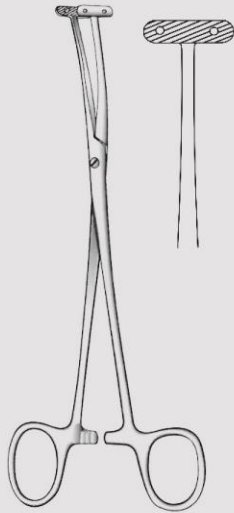


VCB446527

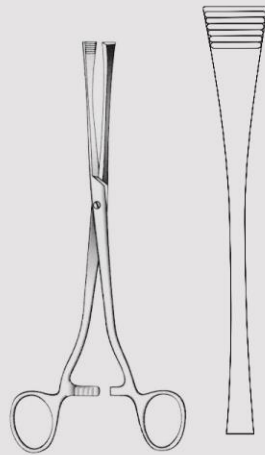
VCB446627



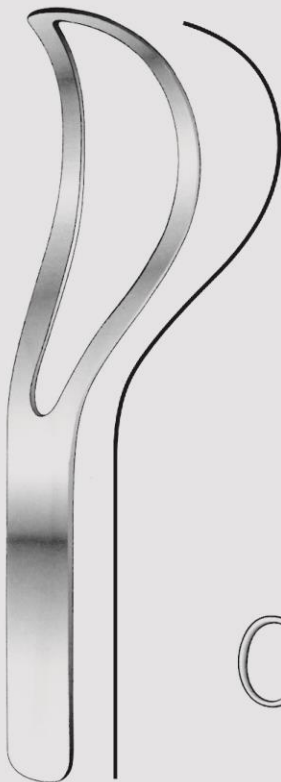
Dubios
27.5 cm / 10 7/8"
Decapitating (embryotomy) scissors



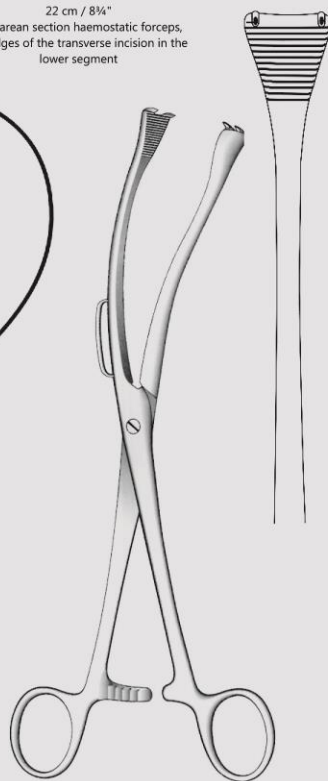
Willet
VCB448019
19 cm / 7½"
Scalp flap forceps



Green-Armytage
VCB447022
22 cm / 8¾"
Caesarean section haemostatic forceps,
for edges of the transverse incision in the
lower segment



Sellheim
VCB447530
30 cm / 12"
Obstetric lever



Gauss
VCB448526
26 cm / 10¼"
Scalp flap forceps



Gynecology
Obstetrics, Scalp Flap Forceps
Geburtshilfe, Kopfsch Wartenzangen
Obstetrique, Pinzas Para Paricraneo

زنان و زایمان
پنس ها



CE

SQS Certificate
ISO 9001:2000
ISO 13485:2003

707



Gynecology
 Ovum Curettes, Abortion Scoops
 Abortus Kuretten Und-Löffel
 Curetas Y Cucharillas Para Aborto

زنان و زایمان
 کورت ها



CE

SQS Certificate
 ISO 9001:2000
 ISO 13485:2003

708



Gyneco

- VCB449000 4 mm Ø
- VCB449100 6 mm Ø
- VCB449200 8 mm Ø
- VCB449300 10 mm Ø
- VCB449400 12 mm Ø
- VCB449500 14 mm Ø
- VCB449600 16 mm Ø



Smellie
 VCB450133
 33 cm / 13"



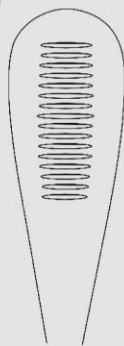
Wallich
 VCB450542
 42 cm / 16½"



- VCB450600 12 mm
- VCB450700 14 mm
- VCB450800 16 mm
- VCB450900 20 mm



Cuzzi
 30 cm / 12"



Toothed back



VCB451530
 14.5 mm
 Blunt



VCB452030
 18 mm
 Blunt

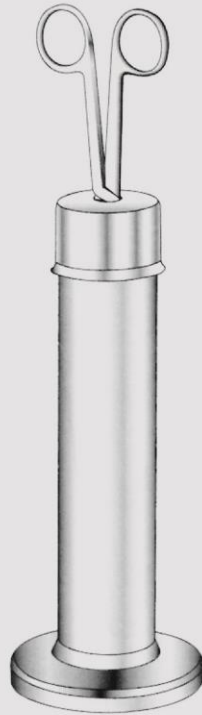


VCB452530
 21 mm
 Blunt



Danis
 VCB453024
 24 cm / 9½"

DIAMOND SURGICAL
WWW.DIAMONDMED.IR INSTRUMENTS



VEE
Sterilization



CE

SQS Certificate
ISO 9001:2000
ISO 13485:2003

709



Sterilization

Sterilizing Forceps, Safety Pins
Sterilisierzangen, Sterilisierklammer
Pinzas para esterilización, Imperdibles para instrumentos

گیره ابزار
پنس ها



SQS Certificate
ISO 9001:2000
ISO 13485:2003

710



Bunt
VEE300112
12 cm / 4 3/4"



Mayo
VEE300514
14 cm / 5 1/2"



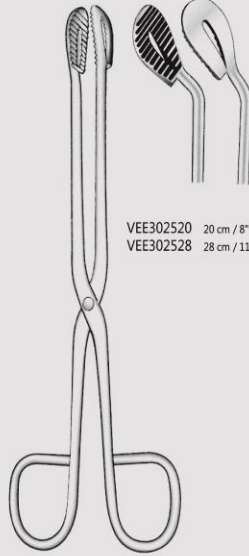
Mayo
VEE301014
14 cm / 5 1/2"



VEE301520 20 cm / 8"
VEE301525 25 cm / 10"
VEE301530 30 cm / 12"
VEE301540 40 cm / 16"
With secure locking device

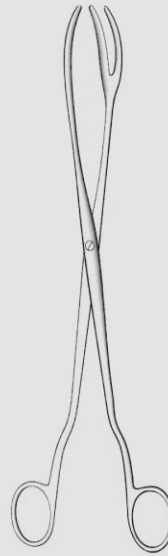


Davis
VEE302016 16 cm / 6 1/4"
VEE302020 20 cm / 8"
VEE302024 24 cm / 9 1/2"

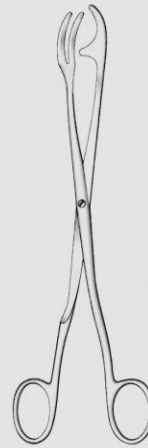


Universal
VEE303020 20 cm / 8"
VEE303028 28 cm / 11"

VEE302520 20 cm / 8"
VEE302528 28 cm / 11"



VEE303520 20 cm / 8"
VEE303530 30 cm / 12"



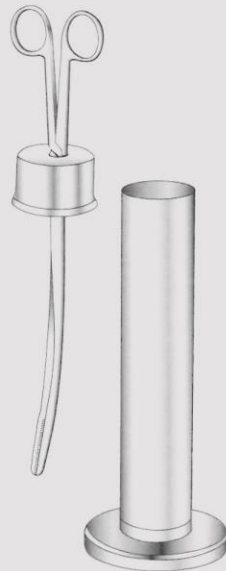
Rogge
VEE304023
23 cm / 9"



Sterilization
Sterilizing Waste Forceps
Forcepskappenzangen
Combinacion tapa/pinza



VEE304500



VEE305000

ظروف استیل
پنس ها



Modell
VEE305528
58 cm / 22 3/4"



Sauerbruch
VEE306055
55 cm / 21 1/2"



CE

SQS Certificate
ISO 9001:2000
ISO 13485:2003

711



Sterilization
Sterilizing Forceps
Sterilisierzangen
Pinzas para esterilizacion

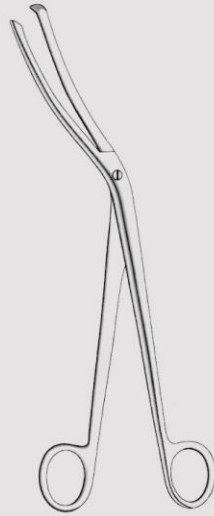
پنس ها



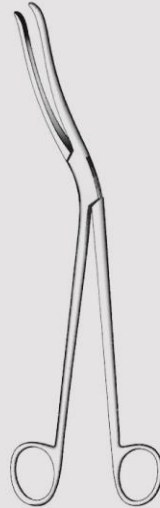
CE

SQS Certificate
ISO 9001:2000
ISO 13485:2003

712



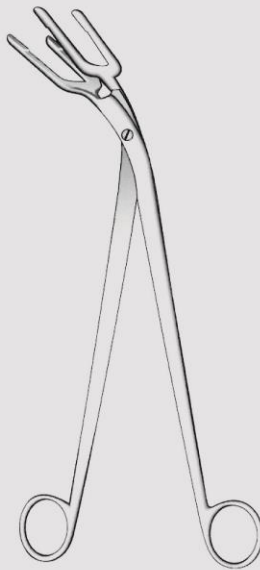
Cheattle
VEE306526
26.5 cm / 10½"



Cheattle
VEE307027
27 cm / 10½"



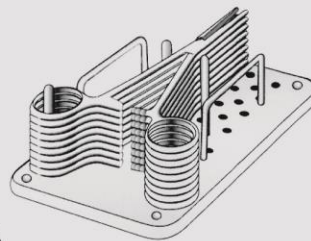
Cheattle
VEE307528
28 cm / 11"



Pye-smith
Harrison
VEE308025 25 cm / 10"
VEE308030 30 cm / 12"

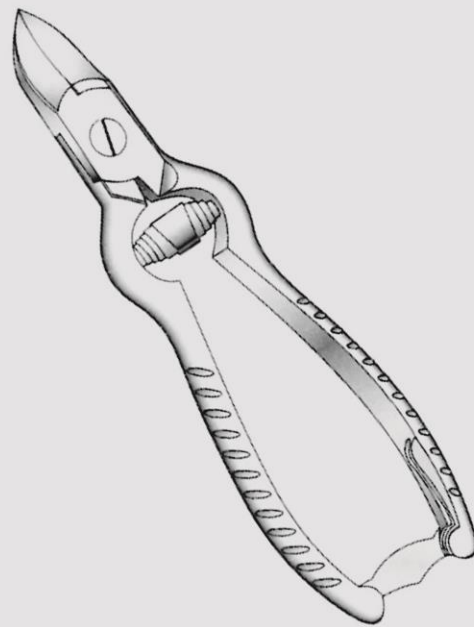


Harrison
VEE308525 25 cm / 10"
VEE308530 30 cm / 12"
VEE308535 35 cm / 14"
VEE308545 45 cm / 18"



VEE309000

DIAMOND SURGICAL
WWW.DIAMONDMED.IR INSTRUMENTS



VED

Nail Instruments



CE

SQS Certificate
ISO 9001:2000
ISO 13485:2003

713



Nail Instruments

Nail Scissors, Nail Nippers
Nagelscheren, Nagelzangen
Tijeras para ungas, Pinzas corta-unas

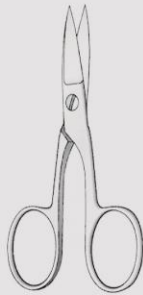
ابزارهای ناخن



CE

SQS Certificate
ISO 9001:2000
ISO 13485:2003

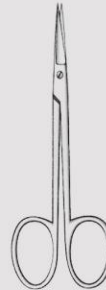
714



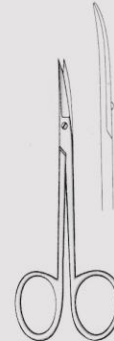
VED040209 9 cm / 3½"
VED040210 10 cm / 4"
VED040211 11 cm / 4½"



VED040609 9 cm / 3½"
VED040610 10 cm / 4"
VED040611 11 cm / 4½"



VED047910
10.5 cm / 4½"



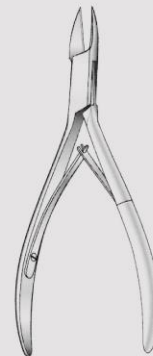
VED048010
10.5 cm / 4½"



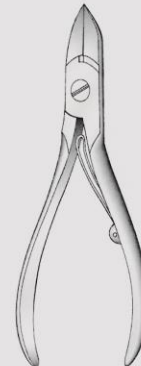
VED047410
10 cm / 4"



VED046611
11.5 cm / 4½"



VED046111 11 cm / 4½"
VED046113 13 cm / 5"
VED046115 15 cm / 6"

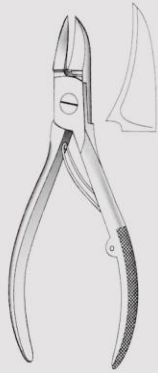


VED045412
12 cm / 4¾"



Nail Instruments

Cuticle Nippers, Nail Nippers, Nail Files
Nagelhautzangen, Nagelzangen, Nagelfeilen
Pinzas Y Tijeras cuticulares, para uñas, Pinzas Cortanñas



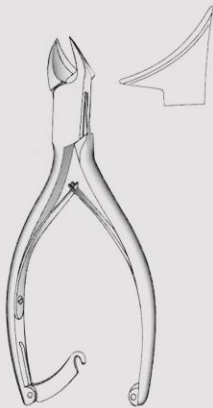
VED044813
13 cm / 5"



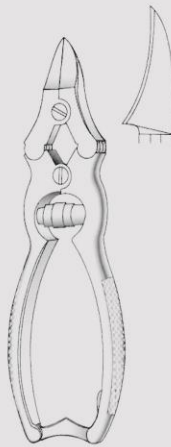
VED043714 14 cm / 5½"
VED043716 16 cm / 6¼"



Turnbull
VED044211 11.5 cm / 4½"
VED044213 13 cm / 5"



VED043214
14 cm / 5½"



VED049015
15.5 cm / 6"



VED048710 10 cm / 4"
VED048712 12 cm / 4¾"



VED048911
11 cm / 4½"

ابزارهای ناخن



CE

SQS Certificate
ISO 9001:2000
ISO 13485:2003

715



Lab. Tools
Measuring Instruments
Mebinstrumente
Instrumentos para medidas

ابزار اندازه گیری



VAG051915 15 cm / 6"
VAG051920 20 cm / 8"
VAG051930 30 cm / 12"
VAG051950 50 cm / 20"



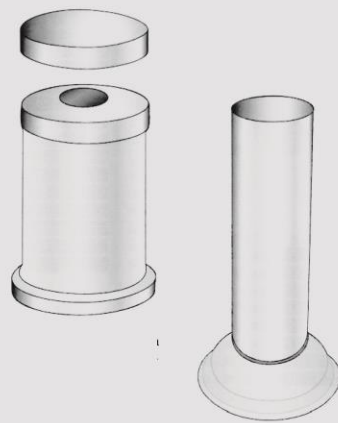
CE

SQS Certificate
ISO 9001:2000
ISO 13485:2003

716

www.Diamondmed.ir

DIAMOND SURGICAL
WWW.DIAMONDMED.IR INSTRUMENTS



VEE VEF

Holloware



CE

SQS Certificate
ISO 9001:2000
ISO 13485:2003

717



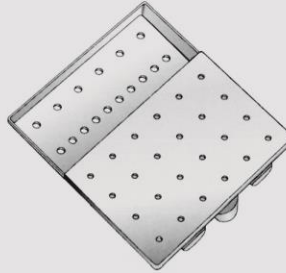
Sterilisation Storage
 Miscellaneous Sterilizing Case with special filter
 Divers sterilisierbehalter mit spezialfilter
 Vanas cajas para esterilizacion con filtro especial

ظروف استریل



SQS Certificate
 ISO 9001:2000
 ISO 13485:2003

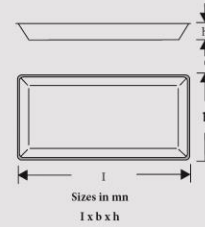
718



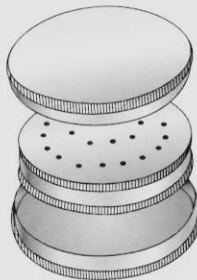
VEE040350 50 x 25 x 4.5 mm
 VEE040365 65 x 42 x 8 mm
 VEE040375 75 x 25 x 4.5 mm



VEE040150 50 x 25 x 4.5 mm
 VEE040165 65 x 42 x 8 mm
 VEE040175 75 x 25 x 4.5 mm

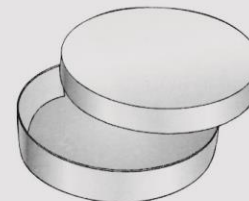


VEE042313
 135 x 100 x 25 mm



VEE041065 65 mm diameter
 Height 15 mm
 Complete with perforated interior box

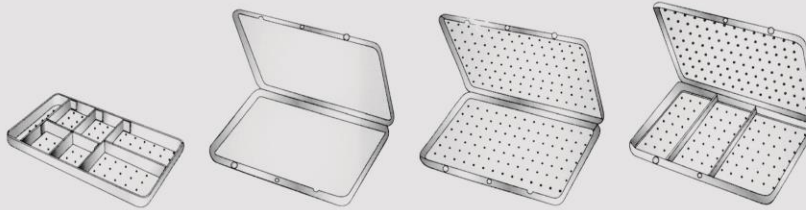
VEE041165 62 mm diameter
 Height 13 mm
 Interior box perforated lid and bottom



dia x height
 VEE200100 100 x 20 mm Dish & Lid
 VEE200200 96 x 20 mm Dish only
 VEE200300 100 x 16 mm Lid only



Sterilization Storage
Needle Sterilizing Cases
Nadel-sterilisierkasten
Estuches para esterilizar agujas



VEE044102
150 x 95 x 11 mm
Perforated bottom
Needle tray

VEE043801
150 x 95 x 13 mm

VEE043802
150 x 95 x 13 mm
Perforated lid and bottom

VEE043605
150 x 95 x 13 mm
Perforated lid and bottom



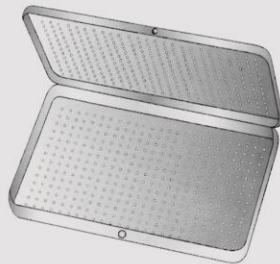
VEE043603
150 x 95 x 13 mm
Perforated bottom



VEE043602
150 x 95 x 13 mm
Perforated lid and bottom



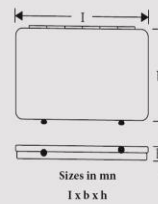
VEE043601
150 x 95 x 13 mm



Sauerbruch
VEE026520
210 x 125 x 17 mm
Perforated lid and bottom



Sauerbruch
VEE026320
210 x 125 x 17 mm
Perforated lid and bottom



Sizes in mm
I x b x h

ظروف استریل



SQS Certificate
ISO 9001:2000
ISO 13485:2003

719



Sterilisation Storage
Miscellaneous Sterilizing Case with special filter
Divers sterilisierbehälter mit spezialfilter
Vanas cajas para esterilización con filtro especial

ظروف استریل



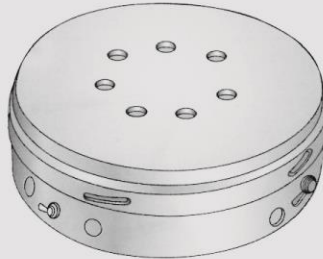
CE

SQS Certificate
ISO 9001:2000
ISO 13485:2003

720

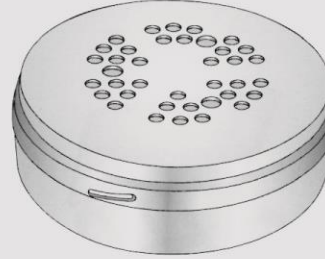


VEE044900
75 mm diameter
Height 75 mm
Strong cup for micro instruments



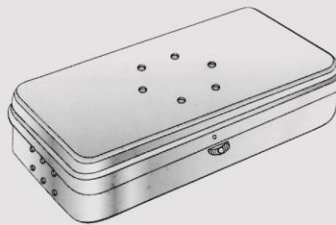
Lid with knob
VEE045213
135 mm diameter
Height 40 mm

Lid without knob
VEE045214
135 mm diameter
Height 40 mm



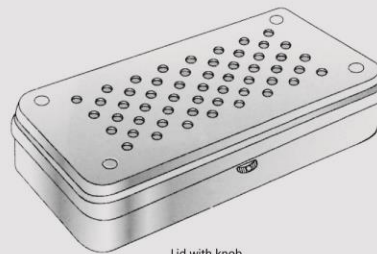
Lid with knob
VEE045313
135 mm diameter
Height 40 mm

Lid without knob
VEE045314
135 mm diameter
Height 40 mm



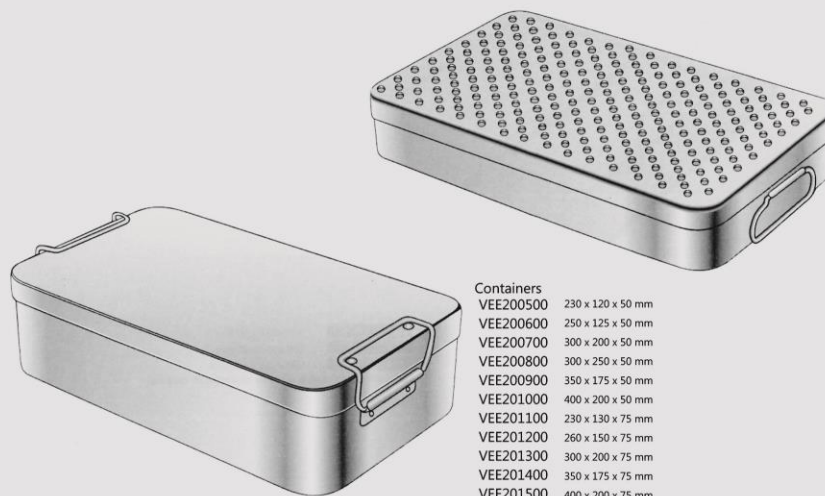
Lid with knob
VEE046420
200 x 100 x 40 mm

Lid without knob
VEE046421
200 x 100 x 40 mm



Lid with knob
VEE046520
200 x 100 x 40 mm

Lid without knob
VEE046521
200 x 100 x 40 mm

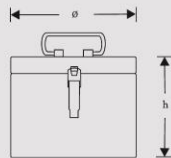


Containers	
VEE200500	230 x 120 x 50 mm
VEE200600	250 x 125 x 50 mm
VEE200700	300 x 200 x 50 mm
VEE200800	300 x 250 x 50 mm
VEE200900	350 x 175 x 50 mm
VEE201000	400 x 200 x 50 mm
VEE201100	230 x 130 x 75 mm
VEE201200	260 x 150 x 75 mm
VEE201300	300 x 200 x 75 mm
VEE201400	350 x 175 x 75 mm
VEE201500	400 x 200 x 75 mm

VEE050035
30 x 15 x 5 cm
height 35 mm
with filter bottom

VEE050050
30 x 15 x 6.5 cm
height 50 mm
with filter bottom

V
VEE050060
30 x 15 x 8 cm
height 60 mm
with filter bottom
Instrument tray with holes at bottom



Konrich	ø x h
VEE204000	100 x 100 mm
VEE204100	150 x 150 mm
VEE204200	200 x 150 mm
VEE204300	200 x 190 mm
VEE204400	240 x 160 mm
VEE204500	240 x 230 mm
VEE204600	290 x 160 mm
VEE204700	290 x 240 mm
VEE204800	340 x 160 mm
VEE204900	340 x 240 mm
VEE205000	390 x 145 mm
VEE205100	390 x 240 mm
VEE205200	390 x 290 mm



Schimmelbusch	ø x h
VEE202000	80 x 80 mm
VEE202100	120 x 120 mm
VEE202200	140 x 140 mm
VEE202300	160 x 120 mm
VEE202400	160 x 150 mm
VEE202500	190 x 150 mm
VEE202600	190 x 190 mm
VEE202700	240 x 160 mm
VEE202800	240 x 240 mm
VEE202900	290 x 160 mm
VEE203000	240 x 240 mm
VEE203100	340 x 160 mm
VEE203200	340 x 240 mm
VEE203300	390 x 190 mm
VEE203400	390 x 290 mm



Sterilizations Storage
Sterilizing and Storing Cases, Sterilizing Boxes
Sterilizer- und Beerdobuthtaketen, Sterilisebehälter
Cajas para esterilización y conservación, Cajas para la esterilización

ظروف استریل

ایزاد جراحی
دایموند

CE

SQS Certificate
ISO 9001:2000
ISO 13485:2003

721



Sterilization Storage
Sterilizing Trays and Baskets DBGGM
Sterilisersieschalen korbe DBGGM
Bandejas de cestas esterilizacion

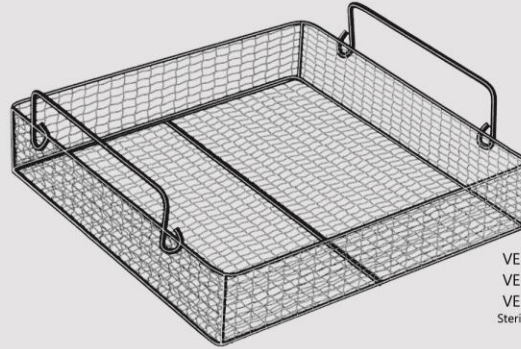
ظروف استریل



CE

SQS Certificate
ISO 9001:2000
ISO 13485:2003

722



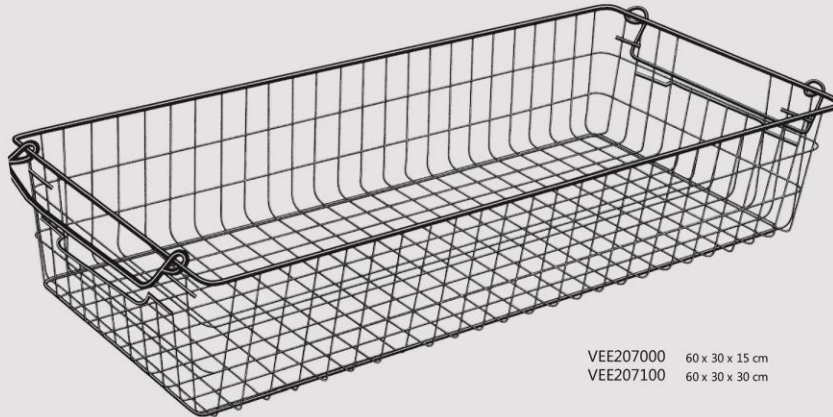
VEE205500 480 x 250 x 50 mm
VEE205600 520 x 250 x 75 mm
VEE205700 520 x 250 x 100 mm

Sterilizing tray of wire mesh for container 60 cm long



VEE206000 240 x 240 x 50 mm
VEE206100 240 x 240 x 80 mm
VEE206200 240 x 240 x 100 mm
VEE206300 480 x 260 x 50 mm
VEE206400 520 x 260 x 80 mm
VEE206500 520 x 260 x 100 mm

Sterilizing tray of perforated steel sheet



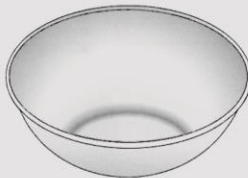
VEE207000 60 x 30 x 15 cm
VEE207100 60 x 30 x 30 cm



VEF200100	0.25 L
VEF200200	0.50 L
VEF200300	1.00 L
VEF200400	2.00 L
Graduated inside	



	dia x h	Capacity
VEF201000	40 x 19 mm	0.05 oz
VEF201100	61 x 30 mm	0.07 oz
VEF201200	80 x 40 mm	0.14 oz
VEF201300	100 x 50 mm	0.35 oz
VEF201400	120 x 55 mm	0.45 oz
VEF201500	140 x 65 mm	0.7 oz
VEF201600	150 x 75 mm	1.1 oz
VEF201700	180 x 85 mm	1.6 oz



Bowl	dia x h	Capacity
VEF202000	100 x 35 mm	0.3 oz
VEF202100	120 x 38 mm	0.4 oz
VEF202200	140 x 40 mm	0.5 oz
VEF202300	150 x 45 mm	0.75 oz
VEF202400	180 x 45 mm	1.0 oz
VEF202500	300 x 90 mm	3.0 oz
VEF202600	350 x 115 mm	5.0 oz



Galipot	Capacity
VEF203000	30 ml / 1 oz
VEF203100	60 ml / 2 oz
VEF203200	90 ml / 3 oz
VEF203300	120 ml / 4 oz
VEF203400	150 ml / 5 oz
VEF203500	180 ml / 6 oz
VEF203600	210 ml / 7 oz
VEF203700	240 ml / 8 oz
VEF203800	270 ml / 9 oz
VEF203900	300 ml / 10 oz
VEF204000	330 ml / 11 oz
VEF204100	360 ml / 12 oz
VEF204200	420 ml / 13 oz
VEF204300	450 ml / 14 oz



	dia x h	Capacity
VEF033611	116 x 35 mm	0.3 oz
VEF033612	128 x 38 mm	0.4 oz
VEF033614	147 x 40 mm	0.5 oz
VEF033616	157 x 45 mm	0.75 oz
VEF033618	187 x 45 mm	1.0 oz



Sterilization Storage

Solution Bowl, Wash & Rinse Bowl, Round Dish, Graduated Measure
 Spulstalen (nummer) was und runde schüssel, runde schüssel, messbecher
 Cúsets para soluciones y redondas, pátangas, platos, copas graduadas

ظروف استریل



SQS Certificate
 ISO 9001:2000
 ISO 13485:2003

723



Sterilization Storage
Kidney Bowls, Trays
Nierenschalen, Schwenkschalen
Cunas, Bandjas rectangulares y redondas

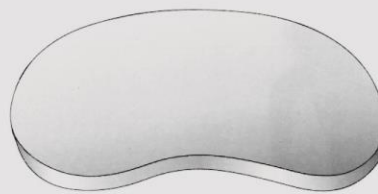
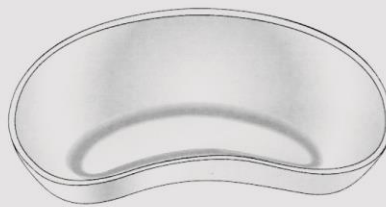
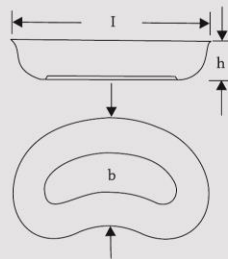
ظروف استریل



CE

SQS Certificate
ISO 9001:2000
ISO 13485:2003

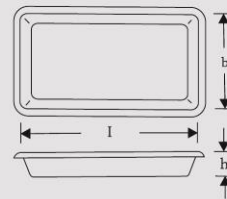
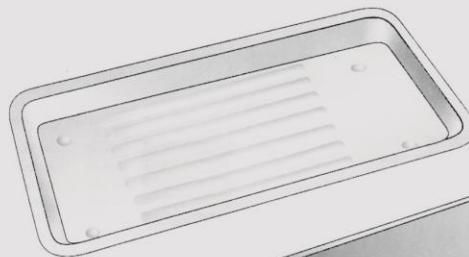
724



Sizes in mm
VEF077417 170 x 100 x 35
VEF077425 250 x 140 x 40
VEF077427 275 x 150 x 45

VEF077625
250 mm x 140 mm x 40 mm
Lid for kidney dish

VEF204500
220 mm x 70 mm



I x b x h
VEF205000 230 x 155 x 30 mm
VEF205100 300 x 200 x 30 mm
VEF205200 300 x 200 x 40 mm
VEF205300 350 x 250 x 36 mm
VEF205400 400 x 300 x 50 mm

www.Diamondmed.ir



Sterilization Storage

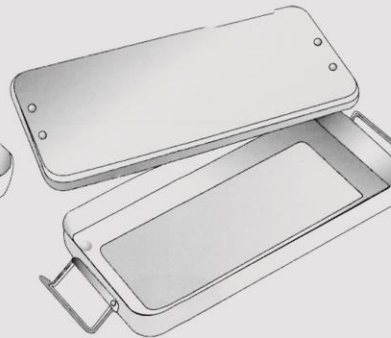
Trays and Instrument Boxes
 Schwenkschalen, Instrumentenkasten
 Bandejas rectangulares y redondas, Cajas para instrumentos



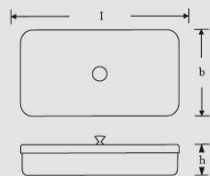
Instrument Tray	Tray with Lid	
VEF206000	200 x 150 x 10	VEF207500
VEF044123	235 x 190 x 40	VEF207600
VEF206100	250 x 200 x 10	VEF207700
VEF206200	300 x 150 x 10	VEF207800
VEF206300	350 x 200 x 10	VEF207900
VEF206400	350 x 250 x 10	VEF208000
VEF206500	400 x 200 x 10	VEF208100
VEF206600	450 x 300 x 10	VEF208200
VEF206700	230 x 155 x 30	VEF208300
VEF206800	300 x 200 x 30	VEF208400
VEF206900	300 x 200 x 40	VEF208500
VEF207000	350 x 250 x 36	VEF208600
VEF207100	400 x 300 x 50	VEF208700



without handle



with side lock



With Handle	Without Handle	With side Lock	I x b x h
VEF209000	VEF210000	VEF211000	150 x 80 x 35 mm
VEF209100	VEF210100	VEF211100	200 x 100 x 35 mm
VEF209200	VEF210200	VEF211200	200 x 100 x 50 mm
VEF209300	VEF210300	VEF211300	230 x 130 x 50 mm
VEF209400	VEF210400	VEF211400	240 x 150 x 50 mm
VEF209500	VEF210500	VEF211500	300 x 250 x 50 mm
VEF209600	VEF210600	VEF211600	300 x 200 x 50 mm
VEF209700	VEF210700	VEF211700	325 x 275 x 50 mm



SQS Certificate
 ISO 9001:2000
 ISO 13485:2003





Sterilization Storage

Cotton Dispenser, Waste Cotton Collector, Metal Jar
 Watzenpendel, Watzenbehälter, watzensammelbehälter, Stanzgefäß
 Dispensadores de algodón, Recipiente para desechos, Tornos metálicos

ظروف استریل



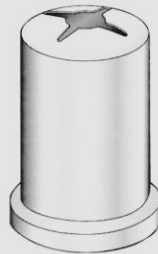
SQS Certificate
 ISO 9001:2000
 ISO 13485:2003

726



Methot
 VEF212000
 50 x 75 mm^Ø
 with lid

Methot
 VEF212500
 50 x 75 mm^Ø
 without lid



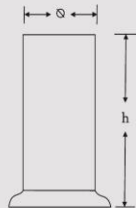
Methot
 VEF213000
 50 x 75 mm^Ø



Methot
 VEF213500
 45 x 55 mm^Ø
 Insert only



VEF214000

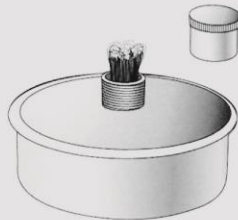


Sizes in mm Ø x h	Jar without lid	Jar with lid	Lid only
30 x 90	VEF046130	VEF046630	VEF046730
50 x 100	VEF046150	VEF046650	VEF046750
50 x 130	VEF046151	VEF046651	VEF046751
50 x 175	VEF046152	VEF046652	VEF046752
75 x 130	VEF046175	VEF046675	VEF046775
75 x 175	VEF046176	VEF046676	VEF046776
80 x 100	VEF046180	VEF046680	VEF046780
80 x 130	VEF046181	VEF046681	VEF046781
80 x 125	VEF046182	VEF046682	VEF046782
100 x 175	VEF046198	VEF046698	VEF046798
100 x 200	VEF046199	VEF046699	VEF046799

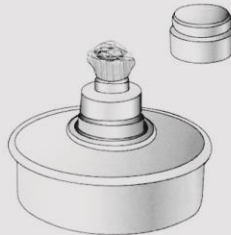


Sterilization Storage

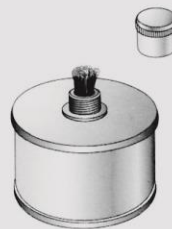
Spirit Lamps, Waste Buckets
Spirituslampen, Abfallzangen
Lamparas de alcohol, Pinzas para desechos



VFB021312
ca. 120 cc



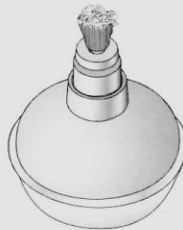
VFB022112
ca. 120 cc



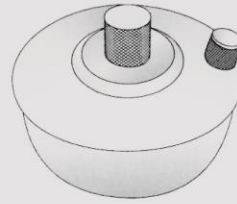
VFB022505
48 x 53 mm
ca. 120 cc



VFB200112
ca. 120 cc



VFB200500



VFB201000



VFB201500
325 x 305 mm
Capacity 15L
Waste bucket



VFB202000
Lid only

ظروف استریل



CE

SQS Certificate
ISO 9001:2000
ISO 13485:2003

727



Sterilization Storage
Different Containers
Verschiedene behälter
Vassoi diversi

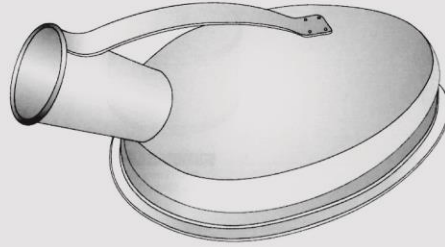
ظروف استریل



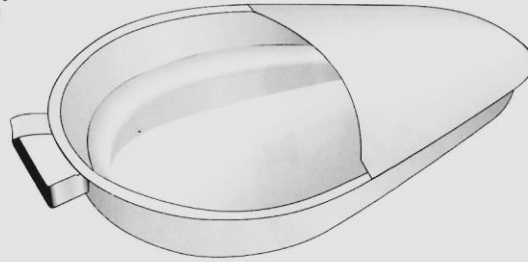
CE

SQS Certificate
ISO 9001:2000
ISO 13485:2003

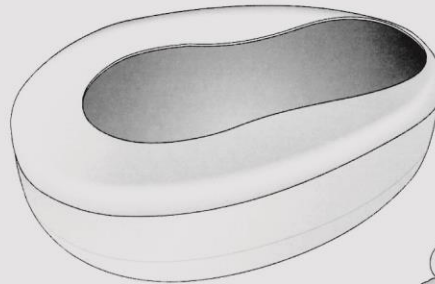
728



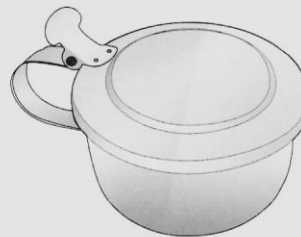
VFB202500
Male Urinal



VFB203000
Urinal



VFB203500
Female Urinal



VFB204000